





## MEET OUR TEAM



**CURTIS LANSBERY**  
PRESIDENT & CEO



**BRIAN KOBISCHKA**  
VICE PRESIDENT  
& CFO



**PHIL SAMUELS**  
DIRECTOR OF SALES  
& MARKETING



**JEFF SHERMAN**  
DIRECTOR OF  
MANUFACTURING



**JON ANDERSON**



**JOY BALDWIN**



**BARB BISHOP**



**JAMIE BURKEE**



**JOSETTE FILLBACH**



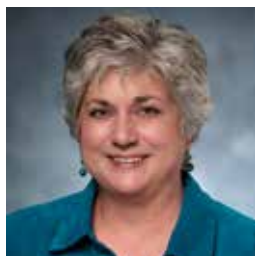
**KERI FISCHER**



**ANITA GRAHAM**



**KELLI HARRIS**



**LORI STURDEVANT**



**BRIDGET TURNER**

**INTRODUCTION**

- 2 Welcome
- 2 Mobile Apps
- 4 History & Overview

**POPULAR SPECIAL TAPS, DIES AND GAGES**

- 5 Machine Screw Sizes
- 15 Fractional & Inch Sizes

**METRIC POPULAR SPECIAL TAPS, DIES AND GAGES**

- 63 Decimal and Metric Conversions
- 64 Metric Sizes

**FEATURED PRODUCTS**

- 80 Application Specific Blueprint Special Taps
- 82 Carbide Taps and Carb-I-Sert Taps
- 84 Carbide, HSS and HSSE Thread Mills
- 85 Smart Cut Tapping and Drilling Fluid

**PRODUCT SPECIFICATIONS**

- 86 Conduit Thread Taps
- 86 Special Spiral Flute Taps
- 87 Special Hand Taps - Inch and Metric
- 89 Tru-Flo™ Thread Forming Taps
- 89 Coolant-Through Taps
- 90 Special Pipe Taps (NPS, NPT, BSPP, BSPT)
- 91 Special Acme Hand Taps and Tandem Style Acme Taps
- 92 Carbide Taps - Inch
- 93 Carbide Taps - Metric
- 93 Carb-I-Sert™ Carbide Insert Taps
- 94 Cost Cutter™ Combined Drill and Tap
- 95 Special Dies & Adapters

**TAP EXTENSIONS**

- 96 Extensions for ANSI Standard Taps
- 97 Extensions for Coolant-Through ANSI Standard Taps
- 98 Extensions for DIN Standard Taps

**ENGINEERING DATA**

- 99 Tap Marking System
- 100 UNJ Thread Form Overview
- 101 Class of Fit - Classes of Threads and Tap Size Overview
- 103 Illustration of Terms Applying to Taps
- 105 Definition of Terms Applying to Taps
- 106 Chamfers for Thread Cutting Taps
- 107 Tap Style Guide
- 108 Thread Plug and Ring Gages Overview
- 109 Tru-Flo™ Thread Forming Taps
- 110 Tap Recommendations for Classes of Thread - Inch
- 111 Tap Recommendations for Classes of Thread - Metric
- 113 Tap / Drill Sizes
- 115 Formula for Tap/Drill Sizes - Inch and Metric
- 117 Hook / Rake Angle Guide / Surface Treatments / Cutting Fluids and Speeds
- 118 Table of Speeds for Taps - Inch and Metric

**TABLES FOR TAP DIMENSIONS**

- 119 Table 302 (incl. Tolerances)
- 121 Table 302-A, Short Thread Length
- 122 Table 303, Fine Pitch
- 123 Table 303-A, Extension Taps
- 124 Table 310, Pulley Taps
- 125 Table 311, Pipe Taps
- 126 Table 338, Taper Pipe Tap Thread Limits
- 127 Table 317, Eccentricity Tolerances
- 127 Surface Treatment Abbreviations
- 128 Tandem Acme Dimensions
- 128 Round Adjustable Dies Technical Data
- 129 General Information
- 130 Limited Warranty / Association Affiliations / ISO Certification

**PRICE LIST**

- PL 1 Fractional & Inch Sizes
- PL 59 Metric Sizes
- PL 75 Tap Extensions

\*\* For simplified selection, tool listings are arranged by size.

\*\* The information on pages 119-127 is excerpted from the "Standards & Dimensions for Ground Thread Taps," published by the United States Cutting Tool Institute. Reproduced with permission of the United States Cutting Tool Institute.

\*\* TRU-FLO™, COST CUTTER™, SMART CUT™, and CARB-I-SERT™ are trademarks of North American Tool Corporation.

\*\* The suggested tap hole sizes shown in this catalog are reference values, and depending on specific tapping requirements and conditions, may have to be altered. Note: These are recommended hole sizes, not drill sizes.



### Welcome to the North American Tool Special Taps, Dies and Gages Catalog 2017 – your first choice for special taps, dies, thread mills and gages.

This catalog has been uniquely designed with all threading tool users and their industrial distributors in mind – from beginner to seasoned expert. We've collaborated with our tool design team to offer an expanded Engineering Data section and an all new Product Specifications section.

For simplified product selection, the catalog features a color-coded Table of Contents, and retains the user-friendly feature of arranging tools by size.

Enhance your experience, and become a tapping expert by using this catalog in unison with our suite of innovative mobile apps. These free apps put technical information at your fingertips to make product selection easy, and offer quick access to engineering data and pricing for popular special taps, dies, and gages.

North American Tool leads the industry as the most competitive, modern manufacturer – and a source you can trust for high-quality special taps, thread mills, dies and gages, delivered when we promise. Designed, produced and shipped in the U.S.A., North American Tool continues to proudly offer 24-hour shipment of Popular Special Taps.

We invest in the people, technology, and processes to deliver high-quality specialized tools for all your needs. North American Tool is committed to providing quick response and outstanding service, and utilizes state-of-the-art equipment and production processes throughout our manufacturing facilities.

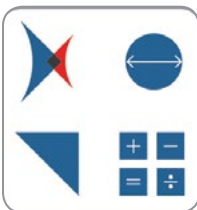
You can count on the North American Tool team for personalized service, quick response, and honest advice to help you find the best solution for your cutting tool needs.

## MOBILE APPS



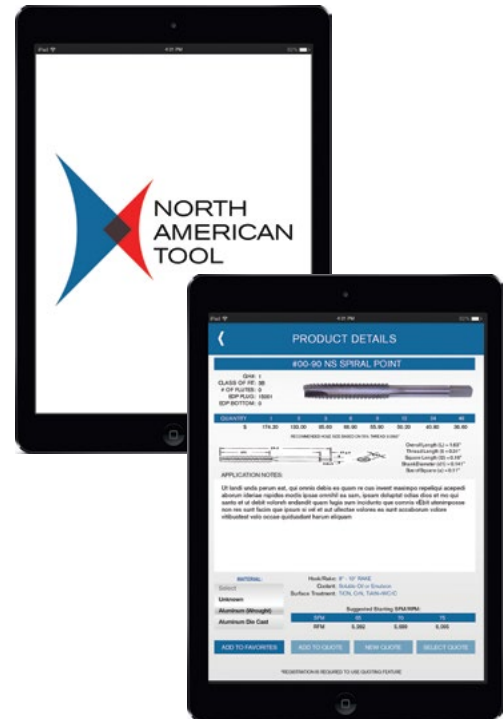
### For Your Tablet: Thread Tap App®

- Complete Catalog and More!
- Available at the App Stores



### For Your Smartphones: Tap Hole Size Calculator

- Recommended Hole Sizes
- Torque/ HP Calculator
- Trigonometry Calculator
- Standard Calculator



### Partner Program Benefits: Partner Branding

- Your logo on the app
- Your contact information on the app
- Unlimited use of Partner Code
- Free!

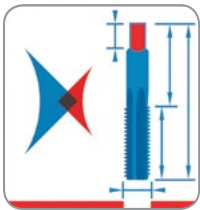




**For Your Desktop: Thread Tap App® Cloud Edition**

- Works in Any Web Browser
- Complete Catalog and More

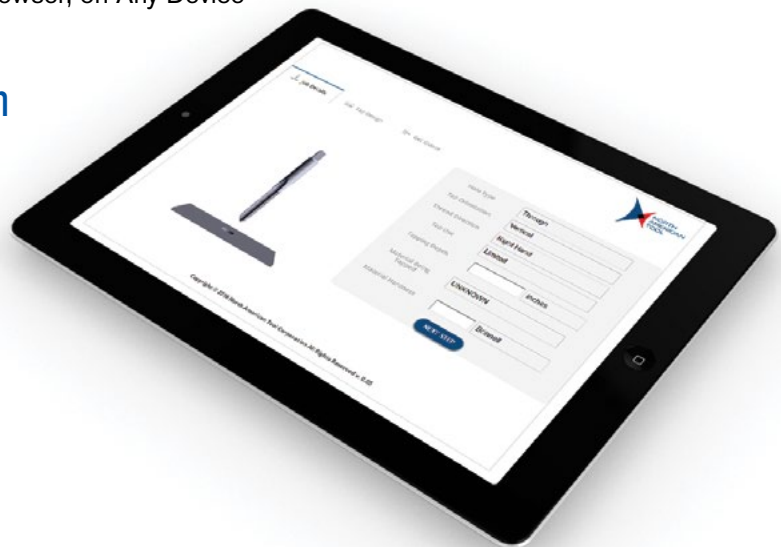
[ThreadTapApp.NATool.com](http://ThreadTapApp.NATool.com)



**For Your Phone, Tablet, and Desktop: Thread Tap Designer**

- Visualize Job Details
- 2D and 3D Design Views
- Expedited Quotation
- Works in Any Web Browser, on Any Device

[Designer.NATool.com](http://Designer.NATool.com)





# HISTORY & OVERVIEW

**North American Tool was founded in 1986**, by the father and son team of Kenyon Y. Taylor and Roger K. Taylor. Working in an area of the country known for its strong industrial roots in the manufacturing and metalworking industries, these seasoned veterans of the cutting tool industry had a vision, recognizing a need for a special tooling company to service a growing U.S. market. The company was founded on three simple principles and ideals:

- Outstanding Customer Service
- Quality Products
- On Time Shipments

Since its inception, North American Tool has become a respected manufacturer of made-to-order cutting tools. The company's success is based on its strong

partnerships with its distributors and their customers born out of mutual respect, trust and down-to-earth communication.

Today, North American Tool Corporation is a precision manufacturer of special cutting tools, namely special taps, thread mills, threading dies and thread gages. The company continues a strong commitment to quality and service by offering industrial distributors and their customers a line of special, custom designed cutting tools made by American craftsmen to critical, exacting specifications. Engineered and manufactured with precise attention to detail, North American Tool products are known the world over for unmatched performance.

The company, located in South Beloit, Illinois, is an ISO registered manufacturer and applies lean manufacturing and continuous improvement principles throughout the manufacturing and customer service process.

## North American Tool's state-of-the-art manufacturing and customer service facility located in South Beloit, IL



SIZE/ DESCRIPTION	GH #	CLASS OF FIT	# FLUTES	ITEM #		OVERALL LENGTH	THREAD LENGTH	SHANK DIAMETER	SQUARE DIAMETER	SQUARE LENGTH
				Click on Item Number below for Price List						
				PLUG	BOTTOM					
<b>#00-90 NS</b>						<i>Recommended Hole Size Based on 75% Thread = .0362"</i>				
SPIRAL POINT TAP	1	3B		15001		1.63	0.31	0.1410	0.110	0.19
<b>#00-96 NS</b>						<i>Recommended Hole Size Based on 75% Thread = .0370"</i>				
SPIRAL POINT TAP	1	3B		15003		1.63	0.31	0.1410	0.110	0.19
<b>#0-80 NF</b>						<i>Recommended Hole Size Based on 75% Thread = .0479" TRU-FLO at 65% Thread = .0545"</i>				
L.H. HAND TAP	1	3B	2	17951	17952	1.63	0.31	0.1410	0.110	0.19
L.H. SPIRAL POINT TAP	1	3B		15012		1.63	0.31	0.1410	0.110	0.19
L.H. SPIRAL POINT TAP	1	3B	2	17953		1.63	0.31	0.1410	0.110	0.19
SPIRAL POINT TAP	3			15008		1.63	0.31	0.1410	0.110	0.19
TRU-FLO FORM TAP	2	3B			19000	1.63	0.31	0.1410	0.110	0.19
TRU-FLO FORM TAP	3	2B			19001	1.63	0.31	0.1410	0.110	0.19
SOLID CARBIDE / HAND TAP	2	2B	2	41579	41580	1.63	0.31	0.1410	0.110	0.19
GAGE - Taperlock Style		2B		23003						
GAGE - Taperlock Style		3B		23004						
GAGE - Reversible Style		2B		24194						
GAGE - Reversible Style		3B		24195						
GAGE - Ring-Go		2A		23350						
GAGE - Ring-Go		3A		23351						
GAGE - Ring-NoGo		2A		23352						
GAGE - Ring-NoGo		3A		23353						
<b>#1-56 NS</b>						<i>Recommended Hole Size Based on 75% Thread = .0559"</i>				
SPIRAL POINT TAP	1	3B		15020		1.69	0.38	0.1410	0.110	0.19
<b>#1-64 NC</b>						<i>Recommended Hole Size Based on TRU-FLO at 65% Thread = .0661"</i>				
TRU-FLO FORM TAP	2	3B			19002	1.69	0.38	0.1410	0.110	0.19
TRU-FLO FORM TAP	3	2B			19003	1.69	0.38	0.1410	0.110	0.19
GAGE - Taperlock Style		2B		23008						
GAGE - Taperlock Style		3B		23009						
GAGE - Reversible Style		2B		24199						
GAGE - Reversible Style		3B		24200						
GAGE - Ring-Go		2A		23356						
GAGE - Ring-Go		3A		23357						
GAGE - Ring-NoGo		2A		23358						
GAGE - Ring-NoGo		3A		23359						
<b>#1-72 NF</b>						<i>Recommended Hole Size Based on TRU-FLO at 65% Thread = .0669"</i>				
TRU-FLO FORM TAP	2	3B			19004	1.69	0.38	0.1410	0.110	0.19
TRU-FLO FORM TAP	3	2B			19005	1.69	0.38	0.1410	0.110	0.19
GAGE - Taperlock Style		2B		23013						
GAGE - Taperlock Style		3B		23014						
GAGE - Reversible Style		2B		24204						
GAGE - Reversible Style		3B		24205						
GAGE - Ring-Go		2A		23362						
GAGE - Ring-Go		3A		23363						
GAGE - Ring-NoGo		2A		23364						
GAGE - Ring-NoGo		3A		23365						

TAPS, DIES & GAGES

Click on Item Number below for Price List

SIZE/ DESCRIPTION	GH #	CLASS OF FIT	# FLUTES	ITEM #		OVERALL LENGTH	THREAD LENGTH	SHANK DIAMETER	SQUARE DIAMETER	SQUARE LENGTH
				PLUG	BOTTOM					
<b>#2-56 NC</b>						<i>Recommended Hole Size Based on 75% Thread = .0689" TRU-FLO at 65% Thread = .0781"</i>				
L.H. HAND TAP	2	2B	2	15038	15039	1.75	0.44	0.1410	0.110	0.19
L H. SPIRAL POINT TAP	2	2B	2	15036		1.75	0.44	0.1410	0.110	0.19
SPIRAL POINT TAP	3		2	17734		1.75	0.44	0.1410	0.110	0.19
HAND TAP	4		2	17763	17764	1.75	0.44	0.1410	0.110	0.19
SPIRAL POINT TAP	4		2	17735		1.75	0.44	0.1410	0.110	0.19
SPIRAL POINT TAP	5		2	17668		1.75	0.44	0.1410	0.110	0.19
SPIRAL POINT +.003 TAP	7		2	17691		1.75	0.44	0.1410	0.110	0.19
TRU-FLO FORM TAP	2	3B			19006	1.75	0.44	0.1410	0.110	0.19
TRU-FLO FORM TAP	3	2B			19007	1.75	0.44	0.1410	0.110	0.19
SOLID CARBIDE / HAND TAP	2	2B	2	41536	41537	1.75	0.44	0.1410	0.110	0.19
SOLID CARBIDE / SP PT TAP	2	2B	2	41538		1.75	0.44	0.1410	0.110	0.19
GAGE - Taperlock Style		2B		23018						
GAGE - Taperlock Style		3B		23019						
GAGE - Reversible Style		2B		24209						
GAGE - Reversible Style		3B		24210						
GAGE - Ring-Go		2A		23368						
GAGE - Ring-Go		3A		23369						
GAGE - Ring-NoGo		2A		23370						
GAGE - Ring-NoGo		3A		23371						
GAGE - STI Plug Taperlock Style		2B		24597						
GAGE - STI Plug Taperlock Style		3B		24598						
<b>#2-64 NF</b>						<i>Recommended Hole Size Based on TRU-FLO at 65% Thread = .0791"</i>				
TRU-FLO FORM TAP	2	3B			19008	1.75	0.44	0.1410	0.110	0.19
TRU-FLO FORM TAP	3	2B			19009	1.75	0.44	0.1410	0.110	0.19
GAGE - Taperlock Style		2B		23023						
GAGE - Taperlock Style		3B		23024						
GAGE - Reversible Style		2B		24214						
GAGE - Reversible Style		3B		24215						
GAGE - Ring-Go		2A		23374						
GAGE - Ring-Go		3A		23375						
GAGE - Ring-NoGo		2A		23376						
GAGE - Ring-NoGo		3A		23377						
<b>#3-48 NC</b>						<i>Recommended Hole Size Based on 75% Thread = .079" TRU-FLO at 65% Thread = .0898"</i>				
L.H. HAND TAP	2	2B	2	15050	15051	1.81	0.50	0.1410	0.110	0.19
L H. SPIRAL POINT TAP	2	2B	2	15048		1.81	0.50	0.1410	0.110	0.19
TRU-FLO FORM TAP	2	3B			19010	1.81	0.50	0.1410	0.110	0.19
TRU-FLO FORM TAP	3	2B			19011	1.81	0.50	0.1410	0.110	0.19
GAGE - Taperlock Style		2B		23028						
GAGE - Taperlock Style		3B		23029						
GAGE - Reversible Style		2B		24219						
GAGE - Reversible Style		3B		24220						
GAGE - Ring-Go		2A		23380						
GAGE - Ring-Go		3A		23381						
GAGE - Ring-NoGo		2A		23382						
GAGE - Ring-NoGo		3A		23383						





SIZE/ DESCRIPTION	GH #	CLASS OF FIT	# FLUTES	Click on Item Number below for Price List		OVERALL LENGTH	THREAD LENGTH	SHANK DIAMETER	SQUARE DIAMETER	SQUARE LENGTH
				ITEM #						
				PLUG	BOTTOM					
<b>#3-48 NC</b>						<i>See Previous Page for Recommended Hole Size</i>				
GAGE - STI Taperlock Style		2B		22028						
GAGE - STI Taperlock Style		3B		22029						
<b>#3-56 NF</b>						<i>Recommended Hole Size Based on TRU-FLO at 65% Thread = .0911"</i>				
TRU-FLO FORM TAP	2	3B		19012		1.81	0.50	0.1410	0.110	0.19
TRU-FLO FORM TAP	3	2B		19013		1.81	0.50	0.1410	0.110	0.19
GAGE - Taperlock Style		2B		23033						
GAGE - Taperlock Style		3B		23034						
GAGE - Reversible Style		2B		24224						
GAGE - Reversible Style		3B		24225						
GAGE - Ring-Go		2A		23386						
GAGE - Ring-Go		3A		23387						
GAGE - Ring-NoGo		2A		23388						
GAGE - Ring-NoGo		3A		23389						
GAGE - STI Taperlock Style		2B		22038						
GAGE - STI Taperlock Style		3B		22039						
<b>#4-32 NS</b>						<i>Recommended Hole Size Based on 75% Thread = .0817"</i>				
HAND TAP	2	2B	3	15062	15063	1.88	0.56	0.1410	0.110	0.19
<b>#4-36 NS</b>						<i>Recommended Hole Size Based on 75% Thread = .0850"</i>				
HAND TAP	2	2B	3	17946	17947	1.88	0.56	0.1410	0.110	0.19
<b>#4-40 NC</b>						<i>Recommended Hole Size Based on 75% Thread = .0878" for STI = .1200" / TRU-FLO at 65% Thread = .1009"</i>				
FAST SPIRAL FLUTE TAP	3		2	17672	17673	1.88	0.56	0.1410	0.110	0.19
L.H. HAND TAP	2	2B	3	15074	15075	1.88	0.56	0.1410	0.110	0.19
L.H. SPIRAL POINT TAP	2	2B	2	15072		1.88	0.56	0.1410	0.110	0.19
HAND TAP	3		3	15080	15081	1.88	0.56	0.1410	0.110	0.19
SPIRAL POINT TAP	3		2	15078		1.88	0.56	0.1410	0.110	0.19
SPIRAL POINT TAP	4		2	17910		1.88	0.56	0.1410	0.110	0.19
SPIRAL POINT TAP	5		2	17593		1.88	0.56	0.1410	0.110	0.19
+.003 SPIRAL POINT TAP	7		2	17670		1.88	0.56	0.1410	0.110	0.19
+.005 SPIRAL POINT TAP	11	PLATING	2	17557		1.88	0.56	0.1410	0.110	0.19
TRU-FLO FORM TAP	3	3B		19014	19015	1.88	0.31	0.1410	0.110	0.19
TRU-FLO FORM TAP	5	2B		19016	19017	1.88	0.31	0.1410	0.110	0.19
SOLID CARBIDE / HAND TAP	2	2B	2	41007	41008	1.88	0.31	0.1410	0.110	0.19
SOLID CARBIDE / SP PT TAP	2	2B	2	41009		1.88	0.31	0.1410	0.110	0.19
COST CUTTER DRILL/TAP	2	2B	2	29000		1.88	0.38	0.1410	0.110	0.19
TiN COAT/SP PT TAP	4		2	50034		1.88	0.56	0.1410	0.110	0.19
STI HAND TAP	1	3B	3	17794	17795	2.00	0.69	0.1410	0.110	0.19
STI SPIRAL POINT TAP	1	3B	2	17796		2.00	0.69	0.1410	0.110	0.19
STI HAND TAP	2	2B	3	17798	17799	2.00	0.69	0.1410	0.110	0.19
STI SPIRAL POINT TAP	2	2B	2	17800		2.00	0.69	0.1410	0.110	0.19
GAGE - Taperlock Style		2B		23038						
GAGE - Taperlock Style		3B		23039						
GAGE - Reversible Style		2B		24229						
GAGE - Reversible Style		3B		24230						
GAGE - Ring-Go		2A		23392						
GAGE - Ring-Go		3A		23393						
GAGE - Ring-NoGo		2A		23394						

TAPS, DIES & GAGES

Click on Item Number below for Price List

SIZE/ DESCRIPTION	GH #	CLASS OF FIT	# FLUTES	ITEM #		OVERALL LENGTH	THREAD LENGTH	SHANK DIAMETER	SQUARE DIAMETER	SQUARE LENGTH
				PLUG	BOTTOM					
<b>#4-40 NC</b>						<i>See Previous Page for Recommended Hole Size</i>				
GAGE - Ring-NoGo		3A		23395						
GAGE - STI Plug Taperlock Style		2B		24617						
GAGE - STI Plug Taperlock Style		3B		24618						
<b>#4-48 NF</b>						<i>Recommended Hole Size Based on 75% Thread = .092" TRU-FLO at 65% Thread = .1028"</i>				
L.H. HAND TAP	2	2B	3	15086	15087	1.88	0.56	0.1410	0.110	0.19
L.H. SPIRAL POINT TAP	2	2B	2	15083		1.88	0.56	0.1410	0.110	0.19
TRU-FLO FORM TAP	3	3B		19018	19019	1.88	0.31	0.1410	0.110	0.19
TRU-FLO FORM TAP	5	2B		19020	19021	1.88	0.31	0.1410	0.110	0.19
SOLID CARBIDE / HAND TAP	2	2B	2	41017	41018	1.88	0.31	0.1410	0.110	0.19
SOLID CARBIDE / SP PT TAP	2	2B	2	41019		1.88	0.31	0.1410	0.110	0.19
GAGE - Taperlock Style		2B		23043						
GAGE - Taperlock Style		3B		23044						
GAGE - Reversible Style		2B		24234						
GAGE - Reversible Style		3B		24235						
GAGE - Ring-Go		2A		23398						
GAGE - Ring-Go		3A		23399						
GAGE - Ring-NoGo		2A		23400						
GAGE - Ring-NoGo		3A		23401						
GAGE - STI Plug Taperlock Style		2B		24622						
GAGE - STI Plug Taperlock Style		3B		24623						
<b>#5-40 NC</b>						<i>Recommended Hole Size Based on 75% Thread = .1008" TRU-FLO at 65% Thread = .1139"</i>				
L.H. HAND TAP	2	3B	3	15098	15099	1.94	0.63	0.1410	0.110	0.19
L.H. SPIRAL POINT TAP	2	3B	2	15096		1.94	0.63	0.1410	0.110	0.19
SPIRAL POINT TAP	5		2	17697		1.94	0.63	0.1410	0.110	0.19
+.003 SPIRAL POINT TAP	7		2	17954		1.94	0.63	0.1410	0.110	0.19
+.005 SPIRAL POINT TAP	11	PLATING	2	17675		1.94	0.63	0.1410	0.110	0.19
TRU-FLO FORM TAP	3	3B		19022	19023	1.94	0.31	0.1410	0.110	0.19
TRU-FLO FORM TAP	5	2B		19024	19025	1.94	0.31	0.1410	0.110	0.19
SOLID CARBIDE / HAND TAP	2	3B	3	41034	41035	1.94	0.31	0.1410	0.110	0.19
SOLID CARBIDE / SP PT TAP	2	3B	2	41032		1.94	0.31	0.1410	0.110	0.19
TiN COAT/SP PT TAP	5		2	50029		1.94	0.63	0.1410	0.110	0.19
R.H. ROUND DIE 13/16"OD				13020						
GAGE - Taperlock Style		2B		23048						
GAGE - Taperlock Style		3B		23049						
GAGE - Reversible Style		2B		24239						
GAGE - Reversible Style		3B		24240						
GAGE - Ring-Go		2A		23404						
GAGE - Ring-Go		3A		23405						
GAGE - Ring-NoGo		2A		23406						
GAGE - Ring-NoGo		3A		23407						
GAGE - STI Plug Taperlock Style		2B		24627						
GAGE - STI Plug Taperlock Style		3B		24628						
<b>#5-44 NF</b>						<i>Recommended Hole Size Based on TRU-FLO at 65% Thread = .1150"</i>				
TRU-FLO FORM TAP	3	3B		19026	19027	1.94	0.31	0.1410	0.110	0.19
TRU-FLO FORM TAP	5	2B		19028	19029	1.94	0.31	0.1410	0.110	0.19



SIZE/ DESCRIPTION	GH #	CLASS OF FIT	# FLUTES	Click on Item Number below for Price List		OVERALL LENGTH	THREAD LENGTH	SHANK DIAMETER	SQUARE DIAMETER	SQUARE LENGTH
				ITEM #						
				PLUG	BOTTOM					
<b>#5-44 NF</b>				<i>See Previous Page for Recommended Hole Size</i>						
GAGE - Taperlock Style		2B		23053						
GAGE - Taperlock Style		3B		23054						
GAGE - Reversible Style		2B		24244						
GAGE - Reversible Style		3B		24245						
GAGE - Ring-Go		2A		23410						
GAGE - Ring-Go		3A		23411						
GAGE - Ring-NoGo		2A		23412						
GAGE - Ring-NoGo		3A		23413						
<b>#6-32 NC</b>				<i>Recommended Hole Size based on 75% Thread = .1077" for STI = .1495" / TRU-FLO at 65% Thread = .1242"</i>						
L.H. HAND TAP	3	2B	3	15110	15111	2.00	0.69	0.1410	0.110	0.25
L.H. SPIRAL POINT TAP	3	2B	2	15108		2.00	0.69	0.1410	0.110	0.25
HAND TAP	5		3	15122	15123	2.00	0.69	0.1410	0.110	0.25
SPIRAL POINT TAP	5		2	15120		2.00	0.69	0.1410	0.110	0.25
+.003 HAND TAP	7		3	15128	15129	2.00	0.69	0.1410	0.110	0.25
+.003 SPIRAL POINT TAP	7		2	15126		2.00	0.69	0.1410	0.110	0.25
+.005 HAND TAP	11	PLATING	3	15134	15135	2.00	0.69	0.1410	0.110	0.25
+.005 SPIRAL POINT TAP	11	PLATING	2	15132		2.00	0.69	0.1410	0.110	0.25
4" EXTENSION SPIRAL POINT TAP	3	2B	2	17605		4.00	0.69	0.1410	0.110	0.25
6" EXTENSION HAND TAP	3	2B	3	15140	15141	6.00	0.69	0.1410	0.110	0.25
6" EXTENSION SPIRAL POINT TAP	3	2B	2	15138		6.00	0.69	0.1410	0.110	0.25
TRU-FLO FORM TAP	3	3B		19030	19031	2.00	0.38	0.1410	0.110	0.19
TRU-FLO FORM TAP	5	2B		19032	19033	2.00	0.38	0.1410	0.110	0.19
TRU-FLO FORM TAP	10	PLATING		19034	19035	2.00	0.38	0.1410	0.110	0.19
SOLID CARBIDE / HAND TAP	3	2B	3	41074	41075	2.00	0.38	0.1410	0.110	0.19
SOLID CARBIDE / SP PT TAP	3	2B	2	41072		2.00	0.38	0.1410	0.110	0.19
COST CUTTER DRILL/TAP	3	2B	2	29004		2.00	0.44	0.1410	0.110	0.19
STI HAND TAP	2	3B	3	17802	17803	2.38	0.88	0.1940	0.152	0.25
STI SPIRAL POINT TAP	2	3B	2	17804		2.38	0.88	0.1940	0.152	0.25
STI HAND TAP	3	2B	3	17806	17807	2.38	0.88	0.1940	0.152	0.25
STI SPIRAL POINT TAP	3	2B	2	17808		2.38	0.88	0.1940	0.152	0.25
R.H. ROUND DIE 1"OD				13022						
L.H. ROUND DIE 1"OD				13023						
GAGE - Taperlock Style		2B		23058						
GAGE - Taperlock Style		3B		23059						
GAGE - Reversible Style		2B		24249						
GAGE - Reversible Style		3B		24250						
GAGE - Ring-Go		2A		23416						
GAGE - Ring-Go		3A		23417						
GAGE - Ring-NoGo		2A		23418						
GAGE - Ring-NoGo		3A		23419						
GAGE - STI Plug Taperlock Style		2B		24637						
GAGE - STI Plug Taperlock Style		3B		24638						
<b>#6-40 NF</b>				<i>Recommended Hole Size based on 75% Thread = .1138" TRU-FLO at 65% Thread = .1269"</i>						
L.H. HAND TAP	2	3B	3	15146	15147	2.00	0.69	0.1410	0.110	0.25
SPIRAL POINT TAP	3		2	15150		2.00	0.69	0.1410	0.110	0.25
TRU-FLO FORM TAP	3	3B		19036	19037	2.00	0.38	0.1410	0.110	0.19

TAPS, DIES & GAGES

Click on Item Number below for Price List

SIZE/ DESCRIPTION	GH #	CLASS OF FIT	# FLUTES	ITEM #		OVERALL LENGTH	THREAD LENGTH	SHANK DIAMETER	SQUARE DIAMETER	SQUARE LENGTH
				PLUG	BOTTOM					
<b>#6-40 NF</b>						<i>See Previous Page for Recommended Hole Size</i>				
TRU-FLO FORM TAP	5	2B		19038	19039	2.00	0.38	0.1410	0.110	0.19
SOLID CARBIDE / HAND TAP	2	3B	3	41092	41093	2.00	0.38	0.1410	0.110	0.19
R.H. ROUND DIE 1"OD				13024						
L.H. ROUND DIE 1"OD				13025						
GAGE - Taperlock Style		2B		23063						
GAGE - Taperlock Style		3B		23064						
GAGE - Reversible Style		2B		24254						
GAGE - Reversible Style		3B		24255						
GAGE - Ring-Go		2A		23422						
GAGE - Ring-Go		3A		23423						
GAGE - Ring-NoGo		2A		23424						
GAGE - Ring-NoGo		3A		23425						
GAGE - STI Plug Taperlock Style		2B		24642						
GAGE - STI Plug Taperlock Style		3B		24643						
<b>#6-48 NS</b>						<i>Recommended Hole Size based on 75% Thread = .118"</i>				
HAND TAP	2	3B	3	15158	15159	2.00	0.69	0.1410	0.110	0.25
SPIRAL POINT TAP	2	3B	2	15156		2.00	0.69	0.1410	0.110	0.25
R.H. ROUND DIE 1"OD				13026						
<b>#8-24 NS</b>						<i>Recommended Hole Size based on 75% Thread = .123"</i>				
HAND TAP	3	3B	4	15164	15165	2.13	0.75	0.1680	0.131	0.25
<b>#8-32 NC</b>						<i>Recommended Hole Size based on 75% Thread = .1337" for STI = .1770" / TRU-FLO at 65% Thread = .1502"</i>				
L.H. HAND TAP	3	2B	4	15170	15171	2.13	0.75	0.1680	0.131	0.25
L.H. SPIRAL POINT TAP	3	2B	2	15168		2.13	0.75	0.1680	0.131	0.25
HAND TAP	5		4	15182	15183	2.13	0.75	0.1680	0.131	0.25
SPIRAL POINT TAP	5		2	15180		2.13	0.75	0.1680	0.131	0.25
+.003 HAND TAP	7		4	15188	15189	2.13	0.75	0.1680	0.131	0.25
+.003 SPIRAL POINT TAP	7		2	15186		2.13	0.75	0.1680	0.131	0.25
+.005 HAND TAP	11	PLATING	4	15194	15195	2.13	0.75	0.1680	0.131	0.25
+.005 SPIRAL POINT TAP	11	PLATING	2	15192		2.13	0.75	0.1680	0.131	0.25
4" EXTENSION SPIRAL POINT TAP	3	2B	2	17582		4.00	0.75	0.1680	0.131	0.25
6" EXTENSION HAND TAP	3	2B	4	15200	15201	6.00	0.75	0.1680	0.131	0.25
6" EXTENSION SPIRAL POINT TAP	3	2B	2	15198		6.00	0.75	0.1680	0.131	0.25
TRU-FLO FORM TAP	3	3B		19040	19041	2.13	0.38	0.1680	0.131	0.25
TRU-FLO FORM TAP	5	2B		19042	19043	2.13	0.38	0.1680	0.131	0.25
TRU-FLO FORM TAP	10	PLATING		19044	19045	2.13	0.38	0.1680	0.131	0.25
SOLID CARBIDE / HAND TAP	3	2B	4	41125	41126	2.13	0.38	0.1680	0.131	0.25
SOLID CARBIDE / SP PT TAP	3	2B	2	41120		2.13	0.38	0.1680	0.131	0.25
COST CUTTER DRILL/TAP	3	2B	2	29006		2.11	0.50	0.1680	0.131	0.25
TiN COAT/SP PT TAP	5		2	50000		2.13	0.75	0.1680	0.131	0.25
STI HAND TAP	2	3B	3	17810	17811	2.38	0.94	0.2200	0.165	0.28
STI SPIRAL POINT TAP	2	3B	2	17812		2.38	0.94	0.2200	0.165	0.28
STI HAND TAP	3	2B	3	17814	17815	2.38	0.94	0.2200	0.165	0.28
STI SPIRAL POINT TAP	3	2B	2	17816		2.38	0.94	0.2200	0.165	0.28
R.H. ROUND DIE 1"OD				13028						
L.H. ROUND DIE 1"OD				13029						



SIZE/ DESCRIPTION	GH #	CLASS OF FIT	# FLUTES	Click on Item Number below for Price List		OVERALL LENGTH	THREAD LENGTH	SHANK DIAMETER	SQUARE DIAMETER	SQUARE LENGTH
				ITEM #						
				PLUG	BOTTOM					
<b>#8-32 NC</b>										
<i>See Previous Page for Recommended Hole Size</i>										
GAGE - Taperlock Style		2B		23068						
GAGE - Taperlock Style		3B		23069						
GAGE - Reversible Style		2B		24259						
GAGE - Reversible Style		3B		24260						
GAGE - Ring-Go		2A		23428						
GAGE - Ring-Go		3A		23429						
GAGE - Ring-NoGo		2A		23430						
GAGE - Ring-NoGo		3A		23431						
GAGE - STI Plug Taperlock Style		2B		24647						
GAGE - STI Plug Taperlock Style		3B		24648						
<b>#8-36 NF</b>										
<i>Recommended Hole Size based on 75% Thread = .137" TRU-FLO at 65% Thread = .1517"</i>										
L.H. HAND TAP	2	3B	4	15206	15207	2.13	0.75	0.1680	0.131	0.25
L.H. SPIRAL POINT TAP	2	3B	2	15204		2.13	0.75	0.1680	0.131	0.25
TRU-FLO FORM TAP	3	3B		19046	19047	2.13	0.38	0.1680	0.131	0.25
TRU-FLO FORM TAP	5	2B		19048	19049	2.13	0.38	0.1680	0.131	0.25
SOLID CARBIDE / HAND TAP	2	3B	4	41147	41148	2.13	0.38	0.1680	0.131	0.25
GAGE - Taperlock Style		2B		23073						
GAGE - Taperlock Style		3B		23074						
GAGE - Reversible Style		2B		24264						
GAGE - Reversible Style		3B		24265						
GAGE - Ring-Go		2A		23434						
GAGE - Ring-Go		3A		23435						
GAGE - Ring-NoGo		2A		23436						
GAGE - Ring-NoGo		3A		23437						
GAGE - STI Plug Taperlock Style		2B		24652						
GAGE - STI Plug Taperlock Style		3B		24653						
<b>#8-40 NS</b>										
<i>Recommended Hole Size based on 75% Thread = .1398"</i>										
HAND TAP	2	3B	4	15218	15219	2.13	0.75	0.1680	0.131	0.25
SPIRAL POINT TAP	2	3B	2	15216		2.13	0.75	0.1680	0.131	0.25
R.H. ROUND DIE 1"OD				13032						
<b>#10-24 NC</b>										
<i>Recommended Hole Size based on 75% Thread = .149" for STI = .2055" / TRUFLO at 65% Thread = .1716"</i>										
L.H. HAND TAP	3	3B	4	15230	15231	2.38	0.88	0.1940	0.152	0.25
L.H. SPIRAL POINT TAP	3	3B	2	15228		2.38	0.88	0.1940	0.152	0.25
HAND TAP	5		4	15236	15237	2.38	0.88	0.1940	0.152	0.25
SPIRAL POINT TAP	5		2	15234		2.38	0.88	0.1940	0.152	0.25
+.003 HAND TAP	7		4	15242	15243	2.38	0.88	0.1940	0.152	0.25
+.003 SPIRAL POINT TAP	7		2	15240		2.38	0.88	0.1940	0.152	0.25
+.005 HAND TAP	11	PLATING	4	15248	15249	2.38	0.88	0.1940	0.152	0.25
+.005 SPIRAL POINT TAP	11	PLATING	2	15246		2.38	0.88	0.1940	0.152	0.25
DOUBLE LEAD TAP	3	3B	4	15254	15255	2.38	0.88	0.1940	0.152	0.25
4" EXTENSION SPIRAL POINT TAP	3	3B	2	17606		4.00	0.88	0.1940	0.152	0.25
6" EXTENSION HAND TAP	3	3B	4	15260	15261	6.00	0.88	0.1940	0.152	0.25
6" EXTENSION SPIRAL POINT TAP	3	3B	2	15258		6.00	0.88	0.1940	0.152	0.25
TRU-FLO FORM TAP	4	3B		19050	19051	2.38	0.50	0.1940	0.152	0.25
TRU-FLO FORM TAP	6	2B		19052	19053	2.38	0.50	0.1940	0.152	0.25



TAPS, DIES & GAGES

Click on Item Number below for Price List

SIZE/ DESCRIPTION	GH #	CLASS OF FIT	# FLUTES	ITEM #		OVERALL LENGTH	THREAD LENGTH	SHANK DIAMETER	SQUARE DIAMETER	SQUARE LENGTH
				PLUG	BOTTOM					
<b>#10-24 NC</b>						<i>See Previous Page for Recommended Hole Size</i>				
TRU-FLO FORM TAP	10	PLATING		19054	19055	2.38	0.50	0.1940	0.152	0.25
SOLID CARBIDE / HAND TAP	3	3B	4	41180	41181	2.38	0.50	0.1940	0.152	0.25
SOLID CARBIDE / SP PT TAP	3	3B	2	41175		2.38	0.50	0.1940	0.152	0.25
COST CUTTER DRILL/TAP	3	3B	2	29008		2.38	0.63	0.1940	0.152	0.25
STI HAND TAP	2	3B	3	17818	17819	2.50	1.00	0.2550	0.191	0.31
STI SPIRAL POINT TAP	2	3B	2	17820		2.50	1.00	0.2550	0.191	0.31
STI HAND TAP	3	2B	3	17822	17823	2.50	1.00	0.2550	0.191	0.31
STI SPIRAL POINT TAP	3	2B	2	17824		2.50	1.00	0.2550	0.191	0.31
R.H. ROUND DIE 1"OD				13036						
L.H. ROUND DIE 1"OD				13037						
GAGE - Taperlock Style		2B		23078						
GAGE - Taperlock Style		3B		23079						
GAGE - Reversible Style		2B		24269						
GAGE - Reversible Style		3B		24270						
GAGE - Ring-Go		2A		23440						
GAGE - Ring-Go		3A		23441						
GAGE - Ring-NoGo		2A		23442						
GAGE - Ring-NoGo		3A		23443						
GAGE - STI Plug Taperlock		2B		24657						
GAGE - STI Plug Taperlock		3B		24658						
<b>#10-28 NS</b>						<i>Recommended Hole Size based on 75% Thread = .1553"</i>				
HAND TAP	3	3B	4	15266	15267	2.38	0.88	0.1940	0.152	0.25
<b>#10-30 NS</b>						<i>Recommended Hole Size based on 75% Thread = .1574"</i>				
HAND TAP	3	3B	4	15272	15273	2.38	0.88	0.1940	0.152	0.25
<b>#10-32 NF</b>						<i>Recommended Hole Size based on 75% Thread = .1597" for STI = .2031" / TRU-FLO at 65% Thread = .1762"</i>				
L.H. HAND TAP	3	2B	4	15278	15279	2.38	0.88	0.1940	0.152	0.25
L.H. SPIRAL POINT TAP	3	2B	2	15276		2.38	0.88	0.1940	0.152	0.25
HAND TAP	4		4	17898	17899	2.38	0.88	0.1940	0.152	0.25
SPIRAL POINT TAP	4		2	15282		2.38	0.88	0.1940	0.152	0.25
HAND TAP	5		4	15290	15291	2.38	0.88	0.1940	0.152	0.25
SPIRAL POINT TAP	5		2	15288		2.38	0.88	0.1940	0.152	0.25
+.003 HAND TAP	7		4	15296	15297	2.38	0.88	0.1940	0.152	0.25
+.003 SPIRAL POINT TAP	7		2	15294		2.38	0.88	0.1940	0.152	0.25
+.005 HAND TAP	11	PLATING	4	15302	15303	2.38	0.88	0.1940	0.152	0.25
+.005 SPIRAL POINT TAP	11	PLATING	2	15300		2.38	0.88	0.1940	0.152	0.25
4" EXTENSION SPIRAL POINT TAP	3	2B	2	17583		4.00	0.88	0.1940	0.152	0.25
6" EXTENSION HAND TAP	3	2B	4	15314	15315	6.00	0.88	0.1940	0.152	0.25
6" EXTENSION SPIRAL POINT TAP	3	2B	2	15312		6.00	0.88	0.1940	0.152	0.25
TRU-FLO FORM TAP	4	3B		19056	19057	2.38	0.50	0.1940	0.152	0.25
TRU-FLO FORM TAP	6	2B		19058	19059	2.38	0.50	0.1940	0.152	0.25
TRU-FLO FORM TAP	10	PLATING		19060	19061	2.38	0.50	0.1940	0.152	0.25
SOLID CARBIDE / HAND TAP	3	2B	4	41213	41214	2.38	0.50	0.1940	0.152	0.25
SOLID CARBIDE / SP PT TAP	3	2B	2	41208		2.38	0.50	0.1940	0.152	0.25
COST CUTTER DRILL/TAP	3	2B	2	29009		2.38	0.63	0.1940	0.152	0.25
TiN COAT/SP PT x 4" TAP	3	2B	2	50025		4.00	0.88	0.1940	0.152	0.25



SIZE/ DESCRIPTION	GH #	CLASS OF FIT	# FLUTES	ITEM #		OVERALL LENGTH	THREAD LENGTH	SHANK DIAMETER	SQUARE DIAMETER	SQUARE LENGTH
				PLUG	BOTTOM					
				Click on Item Number below for Price List						
<b>#10-32 NF</b>				<i>See Previous Page for Recommended Hole Size</i>						
TiN COAT/SP PT TAP	4		2	50001		2.38	0.88	0.1940	0.152	0.25
TiN COAT/SP PT TAP	5		2	50002		2.38	0.88	0.1940	0.152	0.25
TiN COAT/SP PT+.005 TAP	11	PLATING	2	50003		2.38	0.88	0.1940	0.152	0.25
STI HAND TAP	2	3B	3	17826	17827	2.50	1.00	0.2550	0.191	0.31
STI SPIRAL POINT TAP	2	3B	2	17828		2.50	1.00	0.2550	0.191	0.31
STI HAND TAP	3	2B	3	17830	17831	2.50	1.00	0.2550	0.191	0.31
STI SPIRAL POINT TAP	3	2B	2	17832		2.50	1.00	0.2550	0.191	0.31
R.H. ROUND DIE 1"OD				13038						
L.H. ROUND DIE 1"OD				13039						
GAGE - Taperlock Style		2B		23083						
GAGE - Taperlock Style		3B		23084						
GAGE - Reversible Style		2B		24274						
GAGE - Reversible Style		3B		24275						
GAGE - Ring-Go		2A		23446						
GAGE - Ring-Go		3A		23447						
GAGE - Ring-NoGo		2A		23448						
GAGE - Ring-NoGo		3A		23449						
GAGE - STI Plug Taperlock Style		2B		24662						
GAGE - STI Plug Taperlock Style		3B		24663						
<b>#10-36 NS</b>				<i>Recommended Hole Size based on 75% Thread = .163"</i>						
HAND TAP	2	3B	4	15320	15321	2.38	0.88	0.1940	0.152	0.25
R.H. ROUND DIE 1"OD				13040						
<b>#10-40 NS</b>				<i>Recommended Hole Size based on 75% Thread = .1658"</i>						
HAND TAP	2	3B	4	15326	15327	2.38	0.88	0.1940	0.152	0.25
SPIRAL POINT TAP	2	3B	2	15324		2.38	0.88	0.1940	0.152	0.25
R.H. ROUND DIE 1"OD				13042						
<b>#10-48 NS</b>				<i>Recommended Hole Size based on 75% Thread = .1700"</i>						
HAND TAP	2	3B	4	15332	15333	2.38	0.88	0.1940	0.152	0.25
<b>#10-56 NS</b>				<i>Recommended Hole Size based on 75% Thread = .1729"</i>						
HAND TAP	2	3B	4	15338	15339	2.38	0.88	0.1940	0.152	0.25
R.H. ROUND DIE 1"OD				13046						
<b>#10-64 NS</b>				<i>Recommended Hole Size based on 75% Thread = .1749"</i>						
HAND TAP	2	3B	4	15344	15345	2.38	0.88	0.1940	0.152	0.25
<b>.210"-36 NS</b>				<i>Recommended Hole Size based on 75% Thread = .183"</i>						
HAND TAP	3	3B	4	17646	17647	2.38	0.94	0.2200	0.165	0.28
HAND TAP	4	2B	4	17901	17902	2.38	0.94	0.2200	0.165	0.28
<b>#12-24 NC</b>				<i>Recommended Hole Size based on 75% Thread = .175" TRU-FLO at 65% Thread = .1976"</i>						
L.H. HAND TAP	3	3B	4	15374	15375	2.38	0.94	0.2200	0.165	0.28
TRU-FLO FORM TAP	4	3B		19062	19063	2.38	0.50	0.2200	0.165	0.28
TRU-FLO FORM TAP	6	2B		19064	19065	2.38	0.50	0.2200	0.165	0.28
SOLID CARBIDE / HAND TAP	3	3B	4	41246	41247	2.38	0.50	0.2200	0.165	0.28
SOLID CARBIDE / SP PT TAP	3	3B	2	41241		2.38	0.50	0.2200	0.165	0.28
COST CUTTER DRILL/TAP	3	3B	2	29010		2.38	0.66	0.2200	0.165	0.28
L.H. ROUND DIE 1"OD				13049						
GAGE - Taperlock Style		2B		23088						

TAPS, DIES & GAGES

Click on Item Number below for Price List

SIZE/ DESCRIPTION	GH #	CLASS OF FIT	# FLUTES	ITEM #		OVERALL LENGTH	THREAD LENGTH	SHANK DIAMETER	SQUARE DIAMETER	SQUARE LENGTH
				PLUG	BOTTOM					
<b>#12-24 NC</b>						<i>See Previous Page for Recommended Hole Size</i>				
GAGE - Taperlock Style		3B		23089						
GAGE - Reversible Style		2B		24279						
GAGE - Reversible Style		3B		24280						
GAGE - Ring-Go		2A		23452						
GAGE - Ring-Go		3A		23453						
GAGE - Ring-NoGo		2A		23454						
GAGE - Ring-NoGo		3A		23455						
GAGE - STI Plug Taperlock Style		2B		24667						
GAGE - STI Plug Taperlock Style		3B		24668						
<b>#12-28 NF</b>						<i>Recommended Hole Size based on 75% Thread = .1813" TRU-FLO at 65% Thread = .2002"</i>				
L.H. HAND TAP	3	3B	4	15380	15381	2.38	0.94	0.2200	0.165	0.28
TRU-FLO FORM TAP	4	3B		19066	19067	2.38	0.50	0.2200	0.165	0.28
TRU-FLO FORM TAP	6	2B		19068	19069	2.38	0.50	0.2200	0.165	0.28
SOLID CARBIDE / HAND TAP	3	3B	4	41279	41280	2.38	0.50	0.2200	0.165	0.28
SOLID CARBIDE / SP PT TAP	3	3B	2	41274		2.38	0.50	0.2200	0.165	0.28
L.H. ROUND DIE 1"OD				13051						
GAGE - Taperlock Style		2B		23093						
GAGE - Taperlock Style		3B		23094						
GAGE - Reversible Style		2B		24284						
GAGE - Reversible Style		3B		24285						
GAGE - Ring-Go		2A		23458						
GAGE - Ring-Go		3A		23459						
GAGE - Ring-NoGo		2A		23460						
GAGE - Ring-NoGo		3A		23461						
<b>#12-32 NEF</b>						<i>Recommended Hole Size based on 75% Thread = .1857"</i>				
HAND TAP	3	3B	4	15386	15387	2.38	0.94	0.2200	0.165	0.28
SPIRAL POINT TAP	3	3B	2	15384		2.38	0.94	0.2200	0.165	0.28
R.H. ROUND DIE 1"OD				13052						
GAGE - Taperlock Style		2B		23098						
GAGE - Taperlock Style		3B		23099						
GAGE - Reversible Style		2B		22144						
GAGE - Reversible Style		3B		22145						
GAGE - Ring-Go		2A		23464						
GAGE - Ring-Go		3A		23465						
GAGE - Ring-NoGo		2A		23466						
GAGE - Ring-NoGo		3A		23467						
<b>#12-36 NS</b>						<i>Recommended Hole Size based on 75% Thread = .189"</i>				
HAND TAP	2	3B	4	15392	15393	2.38	0.94	0.2200	0.165	0.28
R.H. ROUND DIE 1"OD				13054						
<b>#14-20 NS</b>						<i>Recommended Hole Size based on 75% Thread = .1935"</i>				
HAND TAP	3	3B	4	15398	15399	2.50	1.00	0.2550	0.191	0.31
<b>#14-24 NS</b>						<i>Recommended Hole Size based on 75% Thread = .201"</i>				
HAND TAP	3	3B	4	15404	15405	2.50	1.00	0.2550	0.191	0.31
R.H. ROUND DIE 1"OD				13060						



SIZE/ DESCRIPTION	GH #	CLASS OF FIT	# FLUTES	Click on Item Number below for Price List		OVERALL LENGTH	THREAD LENGTH	SHANK DIAMETER	SQUARE DIAMETER	SQUARE LENGTH
				ITEM #						
				PLUG	BOTTOM					
<b>1/16"-27 PIPE TAP</b>				<i>Recommended Hole Size: NPT/NPTF = .246"</i>						
<b>NPSI NPSF NPT/F NPS</b>										
NPT/F LEFT HAND TAPER TAP			4	15407		2.13	0.69	0.3125	0.234	0.38
NPT/F INT. THD TAP			5	17677		2.13	0.69	0.3125	0.234	0.38
NPT/F 4" EXTENSION TAPER TAP			4	17665		4.00	0.69	0.3125	0.234	0.38
NPT/F 6" EXTENSION TAPER TAP			4	15410		6.00	0.69	0.3125	0.234	0.38
SOLID CARBIDE - NPT/F TAP			4	41800		2.13	0.69	0.3125	0.234	0.38
NPT/F COST CUTTER DRILL/TAP			4	29040		2.81	0.69	0.3125	0.234	0.38
NPS R.H. ROUND DIE 1"OD				13064						
GAGE L1 NPT PLG w/handle				24368						
GAGE L1 NPT RING				24366						
GAGE L1 NPTF PLG w/handle				24418						
GAGE L3 NPTF PLG w/handle				24420						
GAGE NPTF 6 step Plain Plug w/handle				24524						
GAGE L1 NPTF RING				24486						
GAGE L2 NPTF RING				24488						
GAGE NPTF 6 step Plain Ring				24558						
<b>1/8"-27 PIPE TAP</b>				<i>Recommended Drill Size: NPT/NPTF = .332" NPSF/NPSI = .3438"</i>						
<b>NPSI NPSF NPT/F NPS</b>										
NPT/F REG SPR FLT TAPER TAP			4	17554		2.13	0.75	0.4375	0.328	0.38
NPT/F LEFT HAND TAPER TAP			4	15413		2.13	0.75	0.4375	0.328	0.38
NPT/F 4" EXTENSION TAPER TAP			4	15416		4.00	0.75	0.4375	0.328	0.38
NPT/F 6" EXTENSION TAPER TAP			4	15419		6.00	0.75	0.4375	0.328	0.38
NPT/F 6" EXTENSION INT TAPER TAP			5	15422		6.00	0.75	0.4375	0.328	0.38
NPSF EXT x 6" TAP			4	17710		6.00	0.75	0.4375	0.328	0.38
NPT/F 8" EXTENSION TAPER TAP			4	17956		8.00	0.75	0.4375	0.328	0.38
NPT/F 10" EXTENSION TAPER TAP			4	17959		10.00	0.75	0.4375	0.328	0.38
NPT/F 12 EXT TAPER TAP			4	17962		12.00	0.75	0.4375	0.328	0.38
NPSI STRAIGHT TAP			4	15431		2.13	0.75	0.4375	0.328	0.38
SOLID CARBIDE - NPT/F TAP			4	41801		2.13	0.75	0.4375	0.328	0.38
SOLID CARBIDE - NPSF TAP			4	41807		2.13	0.75	0.4375	0.328	0.38
TiN COAT / INT. x 6" NPT/F TAP			5	50004		6.00	0.75	0.4375	0.328	0.38
NPT/F COST CUTTER DRILL/TAP			4	29041		2.88	0.75	0.4375	0.328	0.38
NPT R.H. ROUND DIE 1"OD				13070						
NPS R.H. ROUND DIE 1"OD				13072						
GAGE L1 NPT PLG w/handle				24371						
GAGE L1 NPT RING				24369						
GAGE L1 NPTF PLG w/handle				24426						
GAGE L3 NPTF PLG w/handle				24428						
GAGE NPTF 6 step Plain Plug w/handle				24528						
GAGE L1 NPTF RING				24490						
GAGE L2 NPTF RING				24492						
GAGE NPTF 6 step Plain Ring				24562						

TAPS, DIES & GAGES

Click on Item Number below for Price List

SIZE/ DESCRIPTION	GH #	CLASS OF FIT	# FLUTES	ITEM #		OVERALL LENGTH	THREAD LENGTH	SHANK DIAMETER	SQUARE DIAMETER	SQUARE LENGTH
				PLUG	BOTTOM					
<b>1/8"-28 55° WHITWORTH PIPE</b>				<i>Recommended Hole size BSPT = .3281" / BSPP = .3438"</i>						
BSPT TAPER - MODIFIED TAP			4	15434	15435	2.13	0.75	0.4375	0.328	0.38
BSPP PARALLEL - MODIFIED TAP			4	15437	15438	2.13	0.75	0.4375	0.328	0.38
BSPT TAPER - FULL FORM TAP			4	17932		2.13	0.75	0.4375	0.328	0.38
BSPP PARALLEL - FULL FORM TAP			4	17923		2.13	0.75	0.4375	0.328	0.38
BSPT R.H. ROUND DIE 1 "OD				13692						
BSPP R.H. ROUND DIE 1 "OD				13693						
GAGE BSPP-Mod. DBL END w/handle				27041						
GAGE BSPT-Mod. w/handle				27002						
<b>5/32"-32 NS</b>				<i>Recommended Hole Size based on 75% Thread = .1259"</i>						
HAND TAP	3	2B	4	17560	17561	2.13	0.75	0.1680	0.131	0.25
<b>3/16"-24 NS</b>				<i>Recommended Hole Size based on 75% Thread = .1465"</i>						
HAND TAP	3	3B	4	15443	15444	2.38	0.88	0.1940	0.152	0.25
<b>3/16"-32 NS</b>				<i>Recommended Hole Size based on 75% Thread = .1572"</i>						
HAND TAP	3	2B	4	15449	15450	2.38	0.88	0.1940	0.152	0.25
<b>7/32"-32 NS</b>				<i>Recommended Hole Size based on 75% Thread = .1884"</i>						
HAND TAP	3	2B	4	17565	17566	2.38	0.94	0.2200	0.165	0.28
<b>1/4"-18 PIPE TAP NPSI NPSF NPT/F NPS</b>				<i>Recommended Hole Size: NPT/NPTF = .4375" NPSF / NPSI = .4375"</i>						
NPT/F REG. SPR FLT TAPER TAP			4	15452		2.44	1.06	0.5625	0.421	0.44
NPT/F LEFT HAND TAPER TAP			4	15455		2.44	1.06	0.5625	0.421	0.44
PTF-SAE SHORT PROJ .361 TAP			4	17689	17690	2.44	1.06	0.5625	0.421	0.44
NPT/F 4" EXTENSION TAPER TAP			4	15458		4.00	1.06	0.5625	0.421	0.44
NPT/F 6" EXTENSION TAPER TAP			4	15461		6.00	1.06	0.5625	0.421	0.44
NPT/F 6 INT EXT TAPER TAP			5	15464		6.00	1.06	0.5625	0.421	0.44
NPT/F 8" EXTENSION TAPER TAP			4	15467		8.00	1.06	0.5625	0.421	0.44
NPSF EXT x 6" TAP			4	17703		6.00	1.06	0.5625	0.421	0.44
NPSI STRAIGHT TAP			4	15476		2.44	1.06	0.5625	0.421	0.44
SOLID CARBIDE - NPT/F TAP			4	41802		2.44	1.06	0.5625	0.421	0.44
TiN COAT x 6" NPT/F TAP			4	50005		6.00	1.06	0.5625	0.421	0.44
TiN COAT / INT. x 6" NPT/F TAP			5	50006		6.00	1.06	0.5625	0.421	0.44
NPT/F COST CUTTER DRILL/TAP			4	29042		3.31	1.06	0.5625	0.421	0.44
NPT R.H. ROUND DIE 1-1/2"OD				13092						
NPS R.H. ROUND DIE 1-1/2"OD				13094						
GAGE L1 NPT PLG w/handle				24374						
GAGE L1 NPT RING				24372						
GAGE L1 NPTF PLG w/handle				24434						
GAGE L3 NPTF PLG w/handle				24436						
GAGE NPTF 6 step Plain Plug w/handle				24532						
GAGE L1 NPTF RING				24494						
GAGE L2 NPTF RING				24496						
GAGE NPTF 6 step Plain Ring				24566						





SIZE/ DESCRIPTION	GH #	CLASS OF FIT	# FLUTES	ITEM #		OVERALL LENGTH	THREAD LENGTH	SHANK DIAMETER	SQUARE DIAMETER	SQUARE LENGTH
				PLUG	BOTTOM					
				Click on Item Number below for Price List						
<b>1/4"-19 55° WHITWORTH PIPE</b>				<i>Recommended Hole Size: BSPT = .4375" / BSPP = .4531"</i>						
BSPT TAPER - MODIFIED TAP			4	15479	15480	2.44	1.06	0.5625	0.421	0.44
BSPP PARALLEL - MODIFIED TAP			4	15482	15483	2.44	1.06	0.5625	0.421	0.44
BSPT TAPER - FULL FORM TAP			4	17933		2.44	1.06	0.5625	0.421	0.44
BSPP PARALLEL - FULL FORM TAP			4	17924		2.44	1.06	0.5625	0.421	0.44
BSPT R.H. ROUND DIE 1-1/2"OD				13694						
BSPP R.H. ROUND DIE 1-1/2"OD				13695						
GAGE BSPP-Mod. DBL END w/handle				27044						
GAGE BSPT-Mod. w/handle				27005						
<b>1/4"-20 NC</b>				<i>Recommended Hole Size based on 75% Thread = .2015" for STI = .2660" / TRU-Flo at 65% Thread = .2279"</i>						
FAST SPIRAL FLUTE TAP	5	2B	3	17766	17767	2.50	1.00	0.2550	0.191	0.31
L.H. HAND TAP	3	3B	4	15488	15489	2.50	1.00	0.2550	0.191	0.31
L.H. SPIRAL POINT TAP	3	3B	2	15486		2.50	1.00	0.2550	0.191	0.31
+.003 HAND TAP	7		4	15494	15495	2.50	1.00	0.2550	0.191	0.31
+.003 SPIRAL POINT TAP	7		2	15492		2.50	1.00	0.2550	0.191	0.31
+.005 HAND TAP	11	PLATING	4	15500	15501	2.50	1.00	0.2550	0.191	0.31
+.005 SPIRAL POINT TAP	11	PLATING	2	15498		2.50	1.00	0.2550	0.191	0.31
+.010 HAND TAP	21		4	15506	15507	2.50	1.00	0.2550	0.191	0.31
DOUBLE LEAD TAP	3	3B	4	15512	15513	2.50	1.00	0.2550	0.191	0.31
4" EXTENSION SP PT SM SHK TAP	3	3B	2	17964		4.00	1.00	0.1850	0.138	0.25
4" EXTENSION SPIRAL POINT TAP	3	3B	2	17584		4.00	1.00	0.2550	0.191	0.31
6" EXTENSION HAND TAP	3	3B	4	15518	15519	6.00	1.00	0.2550	0.191	0.31
6" EXTENSION SM SHK HAND TAP	3	3B	4	17570	17571	6.00	1.00	0.1850	0.138	0.25
6" EXTENSION SPIRAL POINT TAP	3	3B	2	15516		6.00	1.00	0.2550	0.191	0.31
6" EXTENSION SP PT SM SHK TAP	3	3B	2	17569		6.00	1.00	0.1850	0.138	0.25
8" EXTENSION HAND TAP	3	3B	4	15524	15525	8.00	1.00	0.2550	0.191	0.31
TRU-FLO FORM TAP	4	3B		19070	19071	2.50	0.63	0.2550	0.191	0.31
TRU-FLO FORM TAP	6	2B		19072	19073	2.50	0.63	0.2550	0.191	0.31
TRU-FLO FORM TAP	10	PLATING		19074	19075	2.50	0.63	0.2550	0.191	0.31
SOLID CARBIDE / HAND TAP	3	3B	4	41312	41313	2.50	0.63	0.2550	0.191	0.31
SOLID CARBIDE / SP PT TAP	3	3B	2	41307		2.50	0.63	0.2550	0.191	0.31
COST CUTTER DRILL/TAP	3	3B	2	29012		2.50	0.78	0.2550	0.191	0.31
TiN COAT/SP PT+.003 TAP	7		2	50007		2.50	1.00	0.2550	0.191	0.31
TiN COAT/SP PT+.005 TAP	11	PLATING	2	50008		2.50	1.00	0.2550	0.191	0.31
TiN COAT/SP PT x 6" TAP	3	3B	2	50009		6.00	1.00	0.2550	0.191	0.31
TiN COAT/SP PT x 6"/SM SHK TAP	3	3B	2	50023		6.00	1.00	0.1850	0.138	0.25
TiN COAT/SP PT x 4" TAP	3	3B	2	50026		4.00	1.00	0.2550	0.191	0.31
STI HAND TAP	2	3B	3	17834	17835	2.72	1.13	0.3180	0.238	0.38
STI SPIRAL POINT TAP	2	3B	2	17836		2.72	1.13	0.3180	0.238	0.38
STI HAND TAP	3	2B	3	17838	17839	2.72	1.13	0.3180	0.238	0.38

TAPS, DIES & GAGES

Click on Item Number below for Price List

SIZE/ DESCRIPTION	GH #	CLASS OF FIT	# FLUTES	ITEM #		OVERALL LENGTH	THREAD LENGTH	SHANK DIAMETER	SQUARE DIAMETER	SQUARE LENGTH
				PLUG	BOTTOM					
<b>1/4"-20 NC</b>						<i>See Previous Page for Recommended Hole Size</i>				
STI SPIRAL POINT TAP	3	2B	2	17840		2.72	1.13	0.3180	0.238	0.38
R.H. ROUND DIE 1"OD				13074						
L.H. ROUND DIE 1"OD				13075						
GAGE - Taperlock Style		2B		23103						
GAGE - Taperlock Style		3B		23104						
GAGE - Reversible Style		2B		24289						
GAGE - Reversible Style		3B		24290						
GAGE - Ring-Go		2A		23470						
GAGE - Ring-Go		3A		23471						
GAGE - Ring-NoGo		2A		23472						
GAGE - Ring-NoGo		3A		23473						
GAGE - STI Plug Taperlock Style		2B		24677						
GAGE - STI Plug Taperlock Style		3B		24678						
<b>1/4"-20 BSW 55° MOD WHITWORTH</b>						<i>Recommended Hole Size = .2020"</i>				
	3		4	15530	15531	2.50	1.00	0.2550	0.191	0.31
<b>1/4"-24 NS</b>						<i>Recommended Hole Size based on 75% Thread = .209"</i>				
HAND TAP	3	3B	4	15536	15537	2.50	1.00	0.2550	0.191	0.31
SPIRAL POINT TAP	3	3B	2	15534		2.50	1.00	0.2550	0.191	0.31
R.H. ROUND DIE 1"OD				13076						
<b>1/4"-26 BSF 55° MOD WHITWORTH</b>						<i>Recommended Hole Size = .2130"</i>				
	3		4	17620	17621	2.50	1.00	0.2550	0.191	0.31
<b>1/4"-27 NS</b>						<i>Recommended Hole Size based on 75% Thread = .214"</i>				
HAND TAP	3	3B	4	15542	15543	2.50	1.00	0.2550	0.191	0.31
R.H. ROUND DIE 1"OD				13078						
<b>1/4"-28 NF</b>						<i>Recommended Hole Size based on 75% Thread = .2153" for STI = .2638" / TRU-FLO at 65% Thread = .2342"</i>				
L.H. HAND TAP	3	3B	4	15548	15549	2.50	1.00	0.2550	0.191	0.31
L.H. SPIRAL POINT TAP	3	3B	2	15546		2.50	1.00	0.2550	0.191	0.31
HAND TAP	5		4	15554	15555	2.50	1.00	0.2550	0.191	0.31
SPIRAL POINT TAP	5		2	15552		2.50	1.00	0.2550	0.191	0.31
+.003 HAND TAP	7		4	15560	15561	2.50	1.00	0.2550	0.191	0.31
+.003 SPIRAL POINT TAP	7		2	15558		2.50	1.00	0.2550	0.191	0.31
+.005 HAND TAP	11	PLATING	4	15566	15567	2.50	1.00	0.2550	0.191	0.31
+.005 SPIRAL POINT TAP	11	PLATING	2	15564		2.50	1.00	0.2550	0.191	0.31
DOUBLE LEAD TAP	3	3B	4	15572	15573	2.50	1.00	0.2550	0.191	0.31
4" EXTENSION SP PT SM SHK TAP	3	3B	2	17965		4.00	1.00	0.1850	0.138	0.25
6" EXTENSION HAND TAP	3	3B	4	15578	15579	6.00	1.00	0.2550	0.191	0.31
6" EXTENSION SPIRAL POINT TAP	3	3B	2	15576		6.00	1.00	0.2550	0.191	0.31
6" EXTENSION SP PT SM SHK TAP	3	3B	2	17607		6.00	1.00	0.1850	0.138	0.25
TRU-FLO FORM TAP	4	3B		19076	19077	2.50	0.63	0.2550	0.191	0.31
TRU-FLO FORM TAP	6	2B		19078	19079	2.50	0.63	0.2550	0.191	0.31



Click on Item Number  
below for Price List

SIZE/ DESCRIPTION	GH #	CLASS OF FIT	# FLUTES	ITEM #		OVERALL LENGTH	THREAD LENGTH	SHANK DIAMETER	SQUARE DIAMETER	SQUARE LENGTH
				PLUG	BOTTOM					
<b>1/4"-28 NF</b>				<i>See Previous Page for Recommended Hole Size</i>						
TRU-FLO FORM TAP	10	PLATING		19080	19081	2.50	0.63	0.2550	0.191	0.31
SOLID CARBIDE / HAND TAP	3	3B	4	41345	41346	2.50	0.63	0.2550	0.191	0.31
SOLID CARBIDE / SP PT TAP	3	3B	2	41340		2.50	0.63	0.2550	0.191	0.31
COST CUTTER DRILL/TAP	3	3B	2	29013		2.50	0.78	0.2550	0.191	0.31
TiN COAT/HAND TAP	5		4		50010	2.50	1.00	0.2550	0.191	0.31
STI HAND TAP	2	3B	3	17842	17843	2.72	1.13	0.3180	0.238	0.38
STI SPIRAL POINT TAP	2	3B	2	17844		2.72	1.13	0.3180	0.238	0.38
STI HAND TAP	3	2B	3	17846	17847	2.72	1.13	0.3180	0.238	0.38
STI SPIRAL POINT TAP	3	2B	2	17848		2.72	1.13	0.3180	0.238	0.38
R.H. ROUND DIE 1"OD				13080						
L.H. ROUND DIE 1"OD				13081						
GAGE - Taperlock Style		2B		23108						
GAGE - Taperlock Style		3B		23109						
GAGE - Reversible Style		2B		24294						
GAGE - Reversible Style		3B		24295						
GAGE - Ring-Go		2A		23476						
GAGE - Ring-Go		3A		23477						
GAGE - Ring-NoGo		2A		23478						
GAGE - Ring-NoGo		3A		23479						
GAGE - STI Plug Taperlock Style		2B		24682						
GAGE - STI Plug Taperlock Style		3B		24683						
<b>1/4"-32 NEF</b>				<i>Recommended Hole Size based on 75% Thread = .2197"</i>						
HAND TAP	3	3B	4	15584	15585	2.50	1.00	0.2550	0.191	0.31
L.H. HAND TAP	3	3B	4	17784	17785	2.50	1.00	0.2550	0.191	0.31
SPIRAL POINT TAP	3	3B	2	15588		2.50	1.00	0.2550	0.191	0.31
HAND TAP	5		4	15590	15591	2.50	1.00	0.2550	0.191	0.31
R.H. ROUND DIE 1"OD				13082						
GAGE - Taperlock Style		2B		23113						
GAGE - Taperlock Style		3B		23114						
GAGE - Reversible Style		2B		24937						
GAGE - Reversible Style		3B		24938						
GAGE - Ring-Go		2A		23482						
GAGE - Ring-Go		3A		23483						
GAGE - Ring-NoGo		2A		23484						
GAGE - Ring-NoGo		3A		23485						
<b>1/4"-36 NS</b>				<i>Recommended Hole Size based on 75% Thread = .2230"</i>						
HAND TAP	2	3B	4	15596	15597	2.50	1.00	0.2550	0.191	0.31
SPIRAL POINT TAP	2	3B	2	15594		2.50	1.00	0.2550	0.191	0.31
HAND TAP	3	2B	4	17759	17760	2.50	1.00	0.2550	0.191	0.31
SPIRAL POINT TAP	3	2B	2	17572		2.50	1.00	0.2550	0.191	0.31
TiN COAT / SP PT TAP	3	2B	2	50024		2.50	1.00	0.2550	0.191	0.31
R.H. ROUND DIE 1"OD				13451						
<b>1/4"-40 NS</b>				<i>Recommended Hole Size based on 75% Thread = .2258"</i>						
HAND TAP	2	3B	4	15602	15603	2.50	1.00	0.2550	0.191	0.31
SPIRAL POINT TAP	2	3B	3	17573		2.50	1.00	0.2550	0.191	0.31
HAND TAP	3	2B	4	15608	15609	2.50	1.00	0.2550	0.191	0.31

TAPS, DIES & GAGES

SIZE/ DESCRIPTION	GH #	CLASS OF FIT	# FLUTES	Click on Item Number below for Price List		OVERALL LENGTH	THREAD LENGTH	SHANK DIAMETER	SQUARE DIAMETER	SQUARE LENGTH
				ITEM #						
				PLUG	BOTTOM					
<b>1/4"-40 NS</b>						<i>See Previous Page for Recommended Hole Size</i>				
R.H. ROUND DIE 1"OD				13084						
<b>1/4"-48 NS</b>						<i>Recommended Hole Size based on 75% Thread = .239"</i>				
HAND TAP	2	3B	4	15614	15615	2.50	1.00	0.2550	0.191	0.31
R.H. ROUND DIE 1"OD				13086						
<b>1/4"-56 NS</b>						<i>Recommended Hole Size based on 75% Thread = .2329"</i>				
HAND TAP	2	3B	4	15620	15621	2.50	1.00	0.2550	0.191	0.31
R.H. ROUND DIE 1"OD				13088						
<b>1/4"-80 NS</b>						<i>Recommended Hole Size based on 75% Thread = .2379"</i>				
HAND TAP	2	3B	4	15638	15639	2.50	1.00	0.2550	0.191	0.31
R.H. ROUND DIE 1"OD				13090						
<b>9/32"-32 NS</b>						<i>Recommended Hole Size based on 75% Thread = .2509"</i>				
HAND TAP	3	2B	4	17589	17590	2.72	1.13	0.3180	0.238	0.38
<b>5/16"-18 NC</b>						<i>Recommended Hole Size based on 75% Thread = .2589" for STI = .3320" / TRU-FLO at 65% Thread = .2879"</i>				
L.H. HAND TAP	3	3B	4	15644	15645	2.72	1.13	0.3180	0.238	0.38
L.H. SPIRAL POINT TAP	3	3B	2	15642		2.72	1.13	0.3180	0.238	0.38
+.003 HAND TAP	7		4	15650	15651	2.72	1.13	0.3180	0.238	0.38
+.003 SPIRAL POINT TAP	7		2	15648		2.72	1.13	0.3180	0.238	0.38
+.005 HAND TAP	11	PLATING	4	15656	15657	2.72	1.13	0.3180	0.238	0.38
+.005 SPIRAL POINT TAP	11	PLATING	2	15654		2.72	1.13	0.3180	0.238	0.38
+.010 HAND TAP	21		4	15662	15663	2.72	1.13	0.3180	0.238	0.38
DOUBLE LEAD TAP	3	3B	4	15668	15669	2.72	1.13	0.3180	0.238	0.38
4" EXTENSION SPIRAL POINT TAP	3	3B	2	17585		4.00	1.13	0.3180	0.238	0.38
4" EXTENSION SP PT SM SHK TAP	3	3B	2	17966		4.00	1.13	0.2400	0.180	0.28
6" EXTENSION HAND TAP	3	3B	4	15673	15674	6.00	1.13	0.3180	0.238	0.38
6" EXTENSION SM SHK HAND TAP	3	3B	4	17608	17609	6.00	1.13	0.2400	0.180	0.28
6" EXTENSION SPIRAL POINT TAP	3	3B	2	15671		6.00	1.13	0.3180	0.238	0.38
6" EXTENSION SP PT SM SHK TAP	3	3B	2	17610		6.00	1.13	0.2400	0.180	0.28
8" EXTENSION HAND TAP	3	3B	4	15678	15679	8.00	1.13	0.3180	0.238	0.38
TRU-FLO FORM TAP	5	3B		19082	19083	2.72	0.69	0.3180	0.238	0.38
TRU-FLO FORM TAP	7	2B		19084	19085	2.72	0.69	0.3180	0.238	0.38
TRU-FLO FORM TAP	10	PLATING		19086	19087	2.72	0.69	0.3180	0.238	0.38
SOLID CARBIDE / HAND TAP	3	3B	4	41378	41379	2.72	0.69	0.3180	0.238	0.38
SOLID CARBIDE / SP PT TAP	3	3B	2	41373		2.72	0.69	0.3180	0.238	0.38
COST CUTTER DRILL/TAP	3	3B	2	29014		2.72	0.94	0.3180	0.238	0.38
TiN COAT / SP PT x 6" TAP	3	3B	2	50011		6.00	1.13	0.3180	0.238	0.38
STI HAND TAP	3	3B	4	17850	17851	2.94	1.25	0.3810	0.286	0.44
STI SPIRAL POINT TAP	3	3B	3	17852		2.94	1.25	0.3810	0.286	0.44
STI HAND TAP	4	2B	4	17854	17855	2.94	1.25	0.3810	0.286	0.44
STI SPIRAL POINT TAP	4	2B	3	17856		2.94	1.25	0.3810	0.286	0.44
R.H. ROUND DIE 1"OD				13100						
L.H. ROUND DIE 1"OD				13101						
GAGE - Taperlock Style		2B		23118						
GAGE - Taperlock Style		3B		23119						



SIZE/ DESCRIPTION	GH #	CLASS OF FIT	# FLUTES	Click on Item Number below for Price List		OVERALL LENGTH	THREAD LENGTH	SHANK DIAMETER	SQUARE DIAMETER	SQUARE LENGTH
				ITEM #						
				PLUG	BOTTOM					
<b>5/16"-18 NC</b>										
<i>See Previous Page for Recommended Hole Size</i>										
GAGE - Reversible Style		2B		24299						
GAGE - Reversible Style		3B		24300						
GAGE - Ring-Go		2A		23488						
GAGE - Ring-Go		3A		23489						
GAGE - Ring-NoGo		2A		23490						
GAGE - Ring-NoGo		3A		23491						
GAGE - STI Plug Taperlock Style		2B		24687						
GAGE - STI Plug Taperlock Style		3B		24688						
<b>5/16"-18 BSW 55° MOD WHITWORTH</b>										
<i>Recommended Hole Size = .2591"</i>										
	3		4	17625	17626	2.72	1.13	0.3180	0.238	0.38
<b>5/16"-20 NS</b>										
<i>Recommended Hole Size based in 75% Thread = .264"</i>										
HAND TAP	3	3B	4	15684	15685	2.72	1.13	0.3180	0.238	0.38
R.H. ROUND DIE 1"OD				13102						
GAGE - Taperlock Style		2B		22169						
GAGE - Taperlock Style		3B		22170						
GAGE - Ring-Go		2A		22171						
GAGE - Ring-Go		3A		22172						
GAGE - Ring-NoGo		2A		22173						
GAGE - Ring-NoGo		3A		22174						
<b>5/16"-22 BSF 55° MOD WHITWORTH</b>										
<i>Recommended Hole Size = .2688"</i>										
	3		4	15690	15691	2.72	1.13	0.3180	0.238	0.38
<b>5/16"-24 NF</b>										
<i>Recommended Hole Size based in 75% Thread = .2715" for STI = .3281" / TRU-FLO at 65% Thread = .2941"</i>										
L.H. HAND TAP	3	3B	4	15696	15697	2.72	1.13	0.3180	0.238	0.38
L.H. SPIRAL POINT TAP	3	3B	2	15694		2.72	1.13	0.3180	0.238	0.38
4" EXTENSION SP PT SM SHK TAP	3	3B	2	17967		4.00	1.13	0.2400	0.180	0.28
HAND TAP	5		4	17650	17651	2.72	1.13	0.3180	0.238	0.38
SPIRAL POINT TAP	5		2	17737		2.72	1.13	0.3180	0.238	0.38
HAND TAP	6		4	17707	17708	2.72	1.13	0.3180	0.238	0.38
+.005 HAND TAP	11	PLATING	4	15708	15709	2.72	1.13	0.3180	0.238	0.38
+.005 SPIRAL POINT TAP	11	PLATING	2	15706		2.72	1.13	0.3180	0.238	0.38
6" EXTENSION HAND TAP	3	3B	4	15713	15714	6.00	1.13	0.3180	0.238	0.38
6" EXTENSION SPIRAL POINT TAP	3	3B	2	15711		6.00	1.13	0.3180	0.238	0.38
6" EXTENSION SP PT SM SHK TAP	3	3B	2	17611		6.00	1.13	0.2400	0.180	0.28
TRU-FLO FORM TAP	5	3B		19088	19089	2.72	0.69	0.3180	0.238	0.38
TRU-FLO FORM TAP	7	2B		19090	19091	2.72	0.69	0.3180	0.238	0.38
TRU-FLO FORM TAP	10	PLATING		19092	19093	2.72	0.69	0.3180	0.238	0.38
SOLID CARBIDE / HAND TAP	3	3B	4	41411	41412	2.72	0.69	0.3180	0.238	0.38
SOLID CARBIDE SP PT TAP	3	3B	2	41406		2.72	0.69	0.3180	0.238	0.38
COST CUTTER DRILL/TAP	3	3B	2	29015		2.72	0.94	0.3180	0.238	0.38
STI HAND TAP	2	3B	4	17858	17859	2.94	1.25	0.3810	0.286	0.44
STI SPIRAL POINT TAP	2	3B	3	17860		2.94	1.25	0.3810	0.286	0.44
STI HAND TAP	3	2B	4	17862	17863	2.94	1.25	0.3810	0.286	0.44



TAPS, DIES & GAGES

Click on Item Number below for Price List

SIZE/ DESCRIPTION	GH #	CLASS OF FIT	# FLUTES	ITEM #		OVERALL LENGTH	THREAD LENGTH	SHANK DIAMETER	SQUARE DIAMETER	SQUARE LENGTH
				PLUG	BOTTOM					
<b>5/16"-24 NF</b>						<i>See Previous Page for Recommended Hole Size</i>				
<b>STI SPIRAL POINT TAP</b>	<b>3</b>	<b>2B</b>	<b>3</b>	<b>17864</b>		<b>2.94</b>	<b>1.25</b>	<b>0.3810</b>	<b>0.286</b>	<b>0.44</b>
R.H. ROUND DIE 1"OD				13104						
L.H. ROUND DIE 1"OD				13105						
GAGE - Taperlock Style		2B		23123						
GAGE - Taperlock Style		3B		23124						
GAGE - Reversible Style		2B		24304						
GAGE - Reversible Style		3B		24305						
GAGE - Ring-Go		2A		23494						
GAGE - Ring-Go		3A		23495						
GAGE - Ring-NoGo		2A		23496						
GAGE - Ring-NoGo		3A		23497						
GAGE - STI Plug Taperlock Style		2B		24692						
GAGE - STI Plug Taperlock Style		3B		24693						
<b>5/16"-27 NS</b>						<i>Recommended Hole Size based on 75% Thread = .2765"</i>				
<b>HAND TAP</b>	<b>3</b>	<b>3B</b>	<b>4</b>	<b>15719</b>	<b>15720</b>	<b>2.72</b>	<b>1.13</b>	<b>0.3180</b>	<b>0.238</b>	<b>0.38</b>
R.H. ROUND DIE 1"OD				13106						
<b>5/16"-28 NS</b>						<i>Recommended Hole Size based on 75% Thread = .2778"</i>				
<b>HAND TAP</b>	<b>3</b>	<b>3B</b>	<b>4</b>	<b>15725</b>	<b>15726</b>	<b>2.72</b>	<b>1.13</b>	<b>0.3180</b>	<b>0.238</b>	<b>0.38</b>
GAGE - Taperlock Style		2B		22183						
GAGE - Taperlock Style		3B		22184						
GAGE - Ring-Go		2A		22185						
GAGE - Ring-Go		3A		22186						
GAGE - Ring-NoGo		2A		22187						
GAGE - Ring-NoGo		3A		22188						
<b>5/16"-32 NEF</b>						<i>Recommended Hole Size based on 75% Thread = .2822"</i>				
<b>HAND TAP</b>	<b>3</b>	<b>3B</b>	<b>4</b>	<b>15730</b>	<b>15731</b>	<b>2.72</b>	<b>1.13</b>	<b>0.3180</b>	<b>0.238</b>	<b>0.38</b>
<b>SPIRAL POINT TAP</b>	<b>3</b>	<b>3B</b>	<b>2</b>	<b>15728</b>		<b>2.72</b>	<b>1.13</b>	<b>0.3180</b>	<b>0.238</b>	<b>0.38</b>
<b>HAND TAP</b>	<b>5</b>		<b>4</b>	<b>15735</b>	<b>15736</b>	<b>2.72</b>	<b>1.13</b>	<b>0.3180</b>	<b>0.238</b>	<b>0.38</b>
R.H. ROUND DIE 1"OD				13108						
GAGE - Taperlock Style		2B		23128						
GAGE - Taperlock Style		3B		23129						
GAGE - Reversible Style		2B		24942						
GAGE - Reversible Style		3B		24943						
GAGE - Ring-Go		2A		23500						
GAGE - Ring-Go		3A		23501						
GAGE - Ring-NoGo		2A		23502						
GAGE - Ring-NoGo		3A		23503						
<b>5/16"-40 NS</b>						<i>Recommended Hole Size based on 75% Thread = .2883"</i>				
<b>HAND TAP</b>	<b>2</b>	<b>3B</b>	<b>4</b>	<b>15740</b>	<b>15741</b>	<b>2.72</b>	<b>1.13</b>	<b>0.3180</b>	<b>0.238</b>	<b>0.38</b>
R.H. ROUND DIE 1"OD				13110						
<b>11/32"-32 NS</b>						<i>Recommended Hole Size based on 75% Thread = .3134"</i>				
<b>HAND TAP</b>	<b>3</b>	<b>3B</b>	<b>4</b>	<b>15750</b>	<b>15751</b>	<b>2.94</b>	<b>1.25</b>	<b>0.3810</b>	<b>0.286</b>	<b>0.44</b>
<b>3/8"-12 ACME</b>						<i>Recommended Hole Size = .2917"</i>				
<b>TANDEM TAP</b>		<b>2G</b>	<b>4</b>	<b>15752</b>		<b>4.06</b>	<b>2.13</b>	<b>0.2550</b>	<b>0.191</b>	<b>0.31</b>



SIZE/ DESCRIPTION	GH #	CLASS OF FIT	# FLUTES	Click on Item Number below for Price List		OVERALL LENGTH	THREAD LENGTH	SHANK DIAMETER	SQUARE DIAMETER	SQUARE LENGTH
				ITEM #						
				PLUG	BOTTOM					
<b>3/8"-16 NC</b>						<i>Recommended Hole Size based on 75% Thread = .3144" for STI = .3970" / TRU-FLO at 65% Thread = .3474"</i>				
FAST SPIRAL FLUTE TAP	5	2B	3	17912	17913	2.94	1.25	0.3810	0.286	0.44
L.H. HAND TAP	3	3B	4	15756	15757	2.94	1.25	0.3810	0.286	0.44
L.H. SPIRAL POINT TAP	3	3B	3	15754		2.94	1.25	0.3810	0.286	0.44
SPIRAL POINT TAP	3	3B	2	17738		2.94	1.25	0.3810	0.286	0.44
+.003 HAND TAP	7		4	15766	15767	2.94	1.25	0.3810	0.286	0.44
+.003 SPIRAL POINT TAP	7		3	15764		2.94	1.25	0.3810	0.286	0.44
+.005 HAND TAP	11	PLATING	4	15771	15772	2.94	1.25	0.3810	0.286	0.44
+.005 SPIRAL POINT TAP	11	PLATING	3	15769		2.94	1.25	0.3810	0.286	0.44
+.010 HAND TAP	21		4	15776	15777	2.94	1.25	0.3810	0.286	0.44
SMALL SHANK TAP	3	3B	4	15761	15762	2.94	1.25	0.2750	0.206	0.38
DOUBLE LEAD TAP	3	3B	4	15781	15782	2.94	1.25	0.3810	0.286	0.44
4" EXTENSION SP PT SM SHK TAP	3	3B	3	17969		4.00	1.25	0.2750	0.206	0.38
4" EXTENSION SPIRAL POINT TAP	3	3B	3	17586		4.00	1.25	0.3810	0.286	0.44
6" EXTENSION HAND TAP	3	3B	4	15786	15787	6.00	1.25	0.3810	0.286	0.44
6" EXTENSION SM SHANK TAP	3	3B	4	15801	15802	6.00	1.25	0.2750	0.206	0.38
6" EXTENSION SPIRAL POINT TAP	3	3B	3	15784		6.00	1.25	0.3810	0.286	0.44
6" EXTENSION SP PT SM SHK TAP	3	3B	3	15799		6.00	1.25	0.2750	0.206	0.38
6" EXTENSION HAND TAP	5	2B	4	17658	17659	6.00	1.25	0.3810	0.286	0.44
6" EXTENSION SPIRAL POINT TAP	5	2B	3	17666		6.00	1.25	0.3810	0.286	0.44
8" EXTENSION HAND TAP	3	3B	4	15791	15792	8.00	1.25	0.3810	0.286	0.44
10" EXTENSION HAND TAP	3	3B	4	15796	15797	10.00	1.25	0.3810	0.286	0.44
TRU-FLO FORM TAP	5	3B		19094	19095	2.94	0.75	0.3810	0.286	0.44
TRU-FLO FORM TAP	7	2B		19096	19097	2.94	0.75	0.3810	0.286	0.44
TRU-FLO FORM TAP	10	PLATING		19098	19099	2.94	0.75	0.3810	0.286	0.44
SOLID CARBIDE / HAND TAP	3	3B	4	41444	41445	2.94	0.75	0.3810	0.286	0.44
SOLID CARBIDE / SP PT TAP	3	3B	3	41442		2.94	0.75	0.3810	0.286	0.44
COST CUTTER DRILL/TAP	3	3B	2	29016		2.94	1.13	0.3810	0.286	0.44
TiN COAT/SP PT x 6" TAP	3	3B	3	50012		6.00	1.25	0.3810	0.286	0.44
TiN COAT/SP PT x 6"/SM SHK TAP	3	3B	3	50013		6.00	1.25	0.2750	0.206	0.38
STI HAND TAP	3	3B	4	17866	17867	3.38	1.66	0.3670	0.275	0.44
STI SPIRAL POINT TAP	3	3B	3	17868		3.38	1.66	0.3670	0.275	0.44
STI HAND TAP	4	2B	4	17870	17871	3.38	1.66	0.3670	0.275	0.44
STI SPIRAL POINT TAP	4	2B	3	17872		3.38	1.66	0.3670	0.275	0.44
R.H. ROUND DIE 1"OD				13116						
L.H. ROUND DIE 1"OD				13117						
GAGE - Taperlock Style		2B		23133						
GAGE - Taperlock Style		3B		23134						
GAGE - Reversible Style		2B		24309						
GAGE - Reversible Style		3B		24310						
GAGE - Ring-Go		2A		23506						
GAGE - Ring-Go		3A		23507						
GAGE - Ring-NoGo		2A		23508						
GAGE - Ring-NoGo		3A		23509						

TAPS, DIES & GAGES

Click on Item Number below for Price List

SIZE/ DESCRIPTION	GH #	CLASS OF FIT	# FLUTES	ITEM #		OVERALL LENGTH	THREAD LENGTH	SHANK DIAMETER	SQUARE DIAMETER	SQUARE LENGTH
				PLUG	BOTTOM					
<b>3/8"-16 NC</b>						<i>See Previous Page for Recommended Hole Size</i>				
GAGE - STI Plug Taperlock Style		2B		24697						
GAGE - STI Plug Taperlock Style		3B		24698						
<b>3/8"-18 NS</b>						<i>Recommended Hole Size based on 75% Thread = .3214"</i>				
HAND TAP	3	3B	4	15806	15807	2.94	1.25	0.3810	0.286	0.44
R.H. ROUND DIE 1"OD				13118						
<b>3/8"-18 PIPE TAP NPSI NPSF NPT/F NPS</b>						<i>Recommended Hole Size: NPT = .5625" / NPTF = .5781" NPSF/NPSI = .5781"</i>				
NPT/F REGULAR SP FLT TAPER TAP			4	15809		2.56	1.06	0.7000	0.531	0.50
NPT/F LEFT HAND TAPER TAP			4	15812		2.56	1.06	0.7000	0.531	0.50
NPT/F 6" EXTENSION TAPER TAP			4	15815		6.00	1.06	0.7000	0.531	0.50
NPT/F 6 INT EXT TAPER TAP			5	15818		6.00	1.06	0.7000	0.531	0.50
NPT/F 8" EXTENSION TAPER TAP			4	15821		8.00	1.06	0.7000	0.531	0.50
NPSI STRAIGHT TAP			4	15827		2.56	1.06	0.7000	0.531	0.50
NPSF 6" EXTENSION TAP			4	17922		6.00	1.06	0.7000	0.531	0.50
NPT/F CARB-I-SERT TAP			4	41808		2.56	0.94	0.7000	0.531	0.50
NPT/F COST CUTTER DRILL/ TAP			4	29043		3.30	1.06	0.7000	0.531	0.50
NPT/F TiN COAT x 6 TAP			4	50014		6.00	1.06	0.7000	0.531	0.50
NPT/F TiN COAT/INT.TH D x 6" TAP			5	50015		6.00	1.06	0.7000	0.531	0.50
NPT R.H. ROUND DIE 1-1/2"OD				13136						
NPS R.H. ROUND DIE 1-1/2"OD				13138						
GAGE L1 NPT PLG w/handle				24377						
GAGE L1 NPT RING				24375						
GAGE L1 NPTF PLG w/handle				24442						
GAGE L3 NPTF PLG w/handle				24444						
GAGE NPTF 6 step Plain Plug w/handle				24536						
GAGE L1 NPTF RING				24498						
GAGE L2 NPTF RING				24500						
GAGE NPTF 6 step Plain Ring				24570						
<b>3/8"-19 55° WHITWORTH PIPE</b>						<i>Recommended Hole Size: BSPT = .5781" / BSPP = 5938"</i>				
BSPT TAPER - MODIFIED TAP			4	15830	15831	2.56	1.06	0.7000	0.531	0.50
BSPP PARALLEL - MODIFIED TAP			4	15833	15834	2.56	1.06	0.7000	0.531	0.50
BSPT TAPER - FULL FORM TAP			4	17934		2.56	1.06	0.7000	0.531	0.50
BSPP PARALLEL - FULL FORM TAP			4	17925		2.56	1.06	0.7000	0.531	0.50
BSPT R.H. ROUND DIE 1-1/2"OD				13696						
BSPP R.H. ROUND DIE 1-1/2"OD				13697						
GAGE BSPP-Mod. DBL END w/handle				27047						
GAGE BSPT-Mod. w/handle				27008						



Click on Item Number  
below for Price List

SIZE/ DESCRIPTION	GH #	CLASS OF FIT	# FLUTES	ITEM #		OVERALL LENGTH	THREAD LENGTH	SHANK DIAMETER	SQUARE DIAMETER	SQUARE LENGTH
				PLUG	BOTTOM					
<b>3/8"-20 NS</b>						<i>Recommended Hole Size based on 75% Thread = .3265"</i>				
HAND TAP	3	3B		15838	15839	2.94	1.25	0.3810	0.286	0.44
R.H. ROUND DIE 1"OD				13120						
GAGE - Taperlock Style		2B		22197						
GAGE - Taperlock Style		3B		22198						
GAGE - Ring-Go		2A		22199						
GAGE - Ring-Go		3A		22200						
GAGE - Ring-NoGo		2A		22201						
GAGE - Ring-NoGo		3A		22202						
<b>3/8"-20 BSF 55° MOD WHITWORTH</b>						<i>Recommended Hole Size = .327"</i>				
	3		4	17630	17631	2.94	1.25	0.3810	0.286	0.44
<b>3/8"-24 NF</b>						<i>Recommended Hole Size based on 75% Thread = .3340" for STI = .3906" / TRU-FLO at 65% Thread = .3566"</i>				
REGULAR SPIRAL FLT TAP	5		3	17724	17725	2.94	1.25	0.3810	0.286	0.44
L.H. HAND TAP	3	3B	4	15843	15844	2.94	1.25	0.3810	0.286	0.44
L.H. SPIRAL POINT TAP	3	3B	3	15841		2.94	1.25	0.3810	0.286	0.44
HAND TAP	5		4	15848	15849	2.94	1.25	0.3810	0.286	0.44
HAND TAP	8		4	17915	17916	2.94	1.25	0.3810	0.286	0.44
SPIRAL POINT TAP	5		3	15846		2.94	1.25	0.3810	0.286	0.44
+.003 HAND TAP	7		4	15853	15854	2.94	1.25	0.3810	0.286	0.44
+.003 SPIRAL POINT TAP	7		3	15851		2.94	1.25	0.3810	0.286	0.44
+.005 HAND TAP	11	PLATING	4	15858	15859	2.94	1.25	0.3810	0.286	0.44
+.005 SPIRAL POINT TAP	11	PLATING	3	15856		2.94	1.25	0.3810	0.286	0.44
4" EXTENSION SP PT SM SHK TAP	3	3B	3	17970		4.00	1.25	0.2750	0.206	0.38
6" EXTENSION HAND TAP	3	3B	4	15863	15864	6.00	1.25	0.3810	0.286	0.44
6" EXTENSION SPIRAL POINT TAP	3	3B	3	15861		6.00	1.25	0.3810	0.286	0.44
TRU-FLO FORM TAP	5	3B		19100	19101	2.94	0.75	0.3810	0.286	0.44
TRU-FLO FORM TAP	7	2B		19102	19103	2.94	0.75	0.3810	0.286	0.44
TRU-FLO FORM TAP	10	PLATING		19104	19105	2.94	0.75	0.3810	0.286	0.44
SOLID CARBIDE / HAND TAP	3	3B	4	41476	41477	2.94	0.75	0.3810	0.286	0.44
COST CUTTER DRILL/TAP	3	3B	2	29017		2.94	1.13	0.3810	0.286	0.44
TiN COAT / +.003 HAND TAP	7		4		50016	2.94	1.25	0.3810	0.286	0.44
STI HAND TAP	2	3B	4	17874	17875	3.16	1.44	0.3230	0.242	0.41
STI SPIRAL POINT TAP	2	3B	3	17876		3.16	1.44	0.3230	0.242	0.41
STI HAND TAP	3	2B	4	17878	17879	3.16	1.44	0.3230	0.242	0.41
STI SPIRAL POINT TAP	3	2B	3	17880		3.16	1.44	0.3230	0.242	0.41
R.H. ROUND DIE 1"OD				13122						
L.H. ROUND DIE 1"OD				13123						
GAGE - Taperlock Style		2B		23138						
GAGE - Taperlock Style		3B		23139						
GAGE - Reversible Style		2B		24314						
GAGE - Reversible Style		3B		24315						
GAGE - Ring-Go		2A		23512						
GAGE - Ring-Go		3A		23513						
GAGE - Ring-NoGo		2A		23514						
GAGE - Ring-NoGo		3A		23515						

TAPS, DIES & GAGES

Click on Item Number below for Price List

SIZE/ DESCRIPTION	GH #	CLASS OF FIT	# FLUTES	ITEM #		OVERALL LENGTH	THREAD LENGTH	SHANK DIAMETER	SQUARE DIAMETER	SQUARE LENGTH
				PLUG	BOTTOM					
<b>3/8"-24 NF</b>						<i>See Previous Page for Recommended Hole Size</i>				
GAGE - STI Plug Taperlock Style		2B		24702						
GAGE - STI Plug Taperlock Style		3B		24703						
<b>3/8"-27 NS</b>						<i>Recommended Hole Size based on 75% Thread = .339"</i>				
<b>HAND TAP</b>	<b>3</b>	<b>3B</b>	<b>4</b>	<b>15868</b>	<b>15869</b>	<b>2.94</b>	<b>1.25</b>	<b>0.3810</b>	<b>0.286</b>	<b>0.44</b>
R.H. ROUND DIE 1"OD				13124						
<b>3/8"-28 NS</b>						<i>Recommended Hole Size based on 75% Thread = .3403"</i>				
<b>HAND TAP</b>	<b>3</b>	<b>3B</b>	<b>4</b>	<b>15873</b>	<b>15874</b>	<b>2.94</b>	<b>1.25</b>	<b>0.3810</b>	<b>0.286</b>	<b>0.44</b>
GAGE - Taperlock Style		2B		22211						
GAGE - Taperlock Style		3B		22212						
GAGE - Ring-Go		2A		22213						
GAGE - Ring-Go		3A		22214						
GAGE - Ring-NoGo		2A		22215						
GAGE - Ring-NoGo		3A		22216						
<b>3/8"-32 NEF</b>						<i>Recommended Hole Size based on 75% Thread = .3447"</i>				
<b>HAND TAP</b>	<b>3</b>	<b>3B</b>	<b>4</b>	<b>15878</b>	<b>15879</b>	<b>2.94</b>	<b>1.25</b>	<b>0.3810</b>	<b>0.286</b>	<b>0.44</b>
<b>SPIRAL POINT TAP</b>	<b>3</b>	<b>3B</b>	<b>3</b>	<b>15876</b>		<b>2.94</b>	<b>1.25</b>	<b>0.3810</b>	<b>0.286</b>	<b>0.44</b>
<b>HAND TAP</b>	<b>5</b>		<b>4</b>	<b>15883</b>	<b>15884</b>	<b>2.94</b>	<b>1.25</b>	<b>0.3810</b>	<b>0.286</b>	<b>0.44</b>
R.H. ROUND DIE 1"OD				13128						
GAGE - Taperlock Style		2B		23143						
GAGE - Taperlock Style		3B		23144						
GAGE - Reversible Style		2B		24947						
GAGE - Reversible Style		3B		24948						
GAGE - Ring-Go		2A		23518						
GAGE - Ring-Go		3A		23519						
GAGE - Ring-NoGo		2A		23520						
GAGE - Ring-NoGo		3A		23521						
<b>3/8"-40 NS</b>						<i>Recommended Hole Size based on 75% Thread = .3508"</i>				
<b>HAND TAP</b>	<b>2</b>	<b>3B</b>	<b>4</b>	<b>15888</b>	<b>15889</b>	<b>2.94</b>	<b>1.25</b>	<b>0.3810</b>	<b>0.286</b>	<b>0.44</b>
<b>HAND TAP</b>	<b>3</b>	<b>2B</b>	<b>4</b>	<b>17615</b>	<b>17616</b>	<b>2.94</b>	<b>1.25</b>	<b>0.3810</b>	<b>0.286</b>	<b>0.44</b>
R.H. ROUND DIE 1"OD				13132						
<b>3/8"-48 NS</b>						<i>Recommended Hole Size based on 75% Thread = .355"</i>				
<b>HAND TAP</b>	<b>2</b>	<b>3B</b>	<b>4</b>	<b>15893</b>	<b>15894</b>	<b>2.94</b>	<b>1.25</b>	<b>0.3810</b>	<b>0.286</b>	<b>0.44</b>
<b>13/32"-32 NS</b>						<i>Recommended Hole Size based on 75% Thread = .3759"</i>				
<b>HAND TAP</b>	<b>3</b>	<b>3B</b>	<b>4</b>	<b>15898</b>	<b>15899</b>	<b>3.16</b>	<b>1.44</b>	<b>0.3230</b>	<b>0.242</b>	<b>0.41</b>
<b>7/16"-14 NC</b>						<i>Recommended Hole Size based on 75% Thread = .3681" for STI = .4531" / TRU-FLO at 65% Thread = .4059"</i>				
<b>L.H. HAND TAP</b>	<b>3</b>	<b>3B</b>	<b>4</b>	<b>15903</b>	<b>15904</b>	<b>3.16</b>	<b>1.44</b>	<b>0.3230</b>	<b>0.242</b>	<b>0.41</b>
<b>L.H. SPIRAL POINT TAP</b>	<b>3</b>	<b>3B</b>	<b>3</b>	<b>15901</b>		<b>3.16</b>	<b>1.44</b>	<b>0.3230</b>	<b>0.242</b>	<b>0.41</b>
<b>+.005 HAND TAP</b>	<b>11</b>	<b>PLATING</b>	<b>4</b>	<b>15908</b>	<b>15909</b>	<b>3.16</b>	<b>1.44</b>	<b>0.3230</b>	<b>0.242</b>	<b>0.41</b>
<b>+.005 SPIRAL POINT TAP</b>	<b>11</b>	<b>PLATING</b>	<b>3</b>	<b>15906</b>		<b>3.16</b>	<b>1.44</b>	<b>0.3230</b>	<b>0.242</b>	<b>0.41</b>
<b>6" EXTENSION HAND TAP</b>	<b>3</b>	<b>3B</b>	<b>4</b>	<b>15933</b>	<b>15934</b>	<b>6.00</b>	<b>1.44</b>	<b>0.3230</b>	<b>0.242</b>	<b>0.41</b>
<b>6" EXTENSION SPIRAL POINT TAP</b>	<b>3</b>	<b>3B</b>	<b>3</b>	<b>15931</b>		<b>6.00</b>	<b>1.44</b>	<b>0.3230</b>	<b>0.242</b>	<b>0.41</b>
<b>TRU-FLO FORM TAP</b>	<b>5</b>	<b>3B</b>		<b>19106</b>	<b>19107</b>	<b>3.16</b>	<b>0.88</b>	<b>0.3230</b>	<b>0.242</b>	<b>0.41</b>
<b>TRU-FLO FORM TAP</b>	<b>8</b>	<b>2B</b>		<b>19108</b>	<b>19109</b>	<b>3.16</b>	<b>0.88</b>	<b>0.3230</b>	<b>0.242</b>	<b>0.41</b>
<b>SOLID CARBIDE / HAND TAP</b>	<b>3</b>	<b>3B</b>	<b>4</b>	<b>41520</b>	<b>41521</b>	<b>3.16</b>	<b>0.88</b>	<b>0.3230</b>	<b>0.242</b>	<b>0.41</b>





Click on Item Number  
below for Price List

SIZE/ DESCRIPTION	GH #	CLASS OF FIT	# FLUTES	ITEM #		OVERALL LENGTH	THREAD LENGTH	SHANK DIAMETER	SQUARE DIAMETER	SQUARE LENGTH
				PLUG	BOTTOM					
<b>7/16"-14 NC</b>						<i>See Previous Page for Recommended Hole Size</i>				
SOLID CARBIDE / SP PT TAP	3	3B	3	41522		3.16	0.88	0.3230	0.242	0.41
COST CUTTER DRILL/TAP	3	3B	2	29018		3.75	1.25	0.3230	0.242	0.41
STI HAND TAP	3	3B	4	17882	17883	3.59	1.66	0.4290	0.322	0.50
STI SPIRAL POINT TAP	3	3B	3	17884		3.59	1.66	0.4290	0.322	0.50
R.H. ROUND DIE 1-1/2"OD				13142						
L.H. ROUND DIE 1-1/2"OD				13143						
GAGE - Taperlock Style		2B		23148						
GAGE - Taperlock Style		3B		23149						
GAGE - Reversible Style		2B		24319						
GAGE - Reversible Style		3B		24320						
GAGE - Ring-Go		2A		23524						
GAGE - Ring-Go		3A		23525						
GAGE - Ring-NoGo		2A		23526						
GAGE - Ring-NoGo		3A		23527						
GAGE - STI Plug Taperlock Style		2B		24707						
GAGE - STI Plug Taperlock Style		3B		24708						
<b>7/16"-16 NS</b>						<i>Recommended Hole Size based on 75% Thread = .3769"</i>				
HAND TAP	3	3B	4	15938	15939	3.16	1.44	0.3230	0.242	0.41
R.H. ROUND DIE 1-1/2"OD				13144						
GAGE - Taperlock Style		2B		22225						
GAGE - Taperlock Style		3B		22226						
GAGE - Ring-Go		2A		22227						
GAGE - Ring-Go		3A		22228						
GAGE - Ring-NoGo		2A		22229						
GAGE - Ring-NoGo		3A		22230						
<b>7/16"-18 NS</b>						<i>Recommended Hole Size based on 75% Thread = .3839"</i>				
HAND TAP	3	3B	4	15943	15944	3.16	1.44	0.3230	0.242	0.41
R.H. ROUND DIE 1-1/2"OD				13146						
<b>7/16"-20 NF</b>						<i>Recommended Hole Size based on 75% Thread = .389" for STI = .4531" / TRU-FLO at 65% Thread = .4154"</i>				
L.H. HAND TAP	3	3B	4	15948	15949	3.16	1.44	0.3230	0.242	0.41
HAND TAP	6		4	17741	17742	3.16	1.44	0.3230	0.242	0.41
+.005 HAND TAP	11	PLATING	4	15963	15964	3.16	1.44	0.3230	0.242	0.41
+.005 SPIRAL POINT TAP	11	PLATING	3	15961		3.16	1.44	0.3230	0.242	0.41
6" PULLEY TAP	3	3B	4	15968	15969	6.00	1.44	0.4440	0.333	0.50
6" EXTENSION HAND TAP	3	3B	4	15973	15974	6.00	1.44	0.3230	0.242	0.41
6" EXTENSION SPIRAL POINT TAP	3	3B	3	15971		6.00	1.44	0.3230	0.242	0.41
TRU-FLO FORM TAP	5	3B		19144	19145	3.16	0.88	0.3230	0.242	0.41
TRU-FLO FORM TAP	8	2B		19146	19147	3.16	0.88	0.3230	0.242	0.41
SOLID CARBIDE / HAND TAP	3	3B	4	41524	41525	3.16	0.88	0.3230	0.242	0.41
SOLID CARBIDE / SP PT TAP	3	3B	3	41526		3.16	0.88	0.3230	0.242	0.41
COST CUTTER DRILL/TAP	3	3B	2	29019		3.75	1.25	0.3230	0.242	0.41
STI HAND TAP	3	3B	4	17886	17887	3.38	1.66	0.3670	0.275	0.44
STI SPIRAL POINT TAP	3	3B	3	17888		3.38	1.66	0.3670	0.275	0.44
R.H. ROUND DIE 1-1/2"OD				13148						
L.H. ROUND DIE 1-1/2"OD				13149						

TAPS, DIES & GAGES

Click on Item Number below for Price List

SIZE/ DESCRIPTION	GH #	CLASS OF FIT	# FLUTES	ITEM #		OVERALL LENGTH	THREAD LENGTH	SHANK DIAMETER	SQUARE DIAMETER	SQUARE LENGTH
				PLUG	BOTTOM					
<b>7/16"-20 NF</b>						<i>See Previous Page for Recommended Hole Size</i>				
GAGE - Taperlock Style		2B		23153						
GAGE - Taperlock Style		3B		23154						
GAGE - Reversible Style		2B		24324						
GAGE - Reversible Style		3B		24325						
GAGE - Ring-Go		2A		23530						
GAGE - Ring-Go		3A		23531						
GAGE - Ring-NoGo		2A		23532						
GAGE - Ring-NoGo		3A		23533						
GAGE - STI Plug Taperlock Style		2B		24712						
GAGE - STI Plug Taperlock Style		3B		24713						
<b>7/16"-24 NS</b>						<i>Recommended Hole Size based on 75% Thread = .3965"</i>				
HAND TAP	3	3B	4	15978	15979	3.16	1.44	0.3230	0.242	0.41
HAND TAP	5	2B	4	15983	15984	3.16	1.44	0.3230	0.242	0.41
R.H. ROUND DIE 1-1/2"OD				13150						
GAGE - Taperlock Style		2B		22239						
GAGE - Taperlock Style		3B		22240						
GAGE - Ring-Go		2A		22241						
GAGE - Ring-Go		3A		22242						
GAGE - Ring-NoGo		2A		22243						
GAGE - Ring-NoGo		3A		22244						
<b>7/16"-27 NS</b>						<i>Recommended Hole Size based on 75% Thread = .4015"</i>				
HAND TAP	3	3B	4	15988	15989	3.16	1.44	0.3230	0.242	0.41
R.H. ROUND DIE 1-1/2"OD				13152						
<b>7/16"-28 NEF</b>						<i>Recommended Hole Size based on 75% Thread = .4028"</i>				
HAND TAP	3	3B	4	15993	15994	3.16	1.44	0.3230	0.242	0.41
HAND TAP	5	2B	4	15998	15999	3.16	1.44	0.3230	0.242	0.41
R.H. ROUND DIE 1-1/2"OD				13154						
GAGE - Taperlock Style		2B		23158						
GAGE - Taperlock Style		3B		23159						
GAGE - Reversible Style		2B		24952						
GAGE - Reversible Style		3B		24953						
GAGE - Ring-Go		2A		23536						
GAGE - Ring-Go		3A		23537						
GAGE - Ring-NoGo		2A		23538						
GAGE - Ring-NoGo		3A		23539						
<b>7/16"-32 NS</b>						<i>Recommended Hole Size based on 75% Thread = .4072"</i>				
HAND TAP	3	3B	4	16003	16004	3.16	1.44	0.3230	0.242	0.41
R.H. ROUND DIE 1-1/2"OD				13156						
GAGE - Taperlock Style		2B		22245						
GAGE - Taperlock Style		3B		22246						
GAGE - Ring-Go		2A		22247						
GAGE - Ring-Go		3A		22248						
GAGE - Ring-NoGo		2A		22249						
GAGE - Ring-NoGo		3A		22250						



Click on Item Number  
below for Price List

SIZE/ DESCRIPTION	GH #	CLASS OF FIT	# FLUTES	ITEM #		OVERALL LENGTH	THREAD LENGTH	SHANK DIAMETER	SQUARE DIAMETER	SQUARE LENGTH
				PLUG	BOTTOM					
<b>7/16"-40 NS</b>						<i>Recommended Hole Size based on 75% Thread = .4133"</i>				
HAND TAP	2	3B	4	16008	16009	3.16	1.44	0.3230	0.242	0.41
R.H. ROUND DIE 1-1/2"OD				13158						
<b>15/32"-32 NS</b>						<i>Recommended Hole Size based on 75% Thread = .4384"</i>				
HAND TAP	3	3B	6	16013	16014	3.38	1.66	0.3670	0.275	0.44
SPIRAL POINT TAP	3	3B	3	16011		3.38	1.66	0.3670	0.275	0.44
R.H. ROUND DIE 1-1/2"OD				13160						
<b>1/2"-10 ACME</b>						<i>Recommended Hole Size = .4000"</i>				
HAND TAP		2G	4	16017		3.38	1.66	0.3670	0.275	0.44
L.H. HAND TAP		2G	4	16021		3.38	1.66	0.3670	0.275	0.44
TANDEM TAP		2G	4	16023		5.00	2.56	0.3670	0.275	0.44
L.H. TANDEM TAP		2G	4	16024		5.00	2.56	0.3670	0.275	0.44
<b>1/2"-12 NS</b>						<i>Recommended Hole Size based on 75% Thread = .4192"</i>				
HAND TAP	3	3B	4	16028	16029	3.38	1.66	0.3670	0.275	0.44
R.H. ROUND DIE 1-1/2"OD				13162						
<b>1/2"-12 BSW 55° MOD WHITWORTH</b>						<i>Recommended Hole Size = .4200"</i>				
	3		4	16033	16034	3.38	1.66	0.3670	0.275	0.44
<b>1/2"-13 NC</b>						<i>Recommended Hole Size based on 75% Thread = .4251" for STI = .5312" / TRU-FLO at 65% Thread = .4660"</i>				
L.H. HAND TAP	3	3B	4	16038	16039	3.38	1.66	0.3670	0.275	0.44
L.H. SPIRAL POINT TAP	3	3B	3	16036		3.38	1.66	0.3670	0.275	0.44
+.003 HAND TAP	7		4	16043	16044	3.38	1.66	0.3670	0.275	0.44
+.005 HAND TAP	11	PLATING	4	16048	16049	3.38	1.66	0.3670	0.275	0.44
+.005 SPIRAL POINT TAP	11	PLATING	3	16046		3.38	1.66	0.3670	0.275	0.44
+.010 HAND TAP	21		4	16053	16054	3.38	1.66	0.3670	0.275	0.44
DOUBLE LEAD TAP	3	3B	4	16058	16059	3.38	1.66	0.3670	0.275	0.44
6" EXTENSION HAND TAP	3	3B	4	16083	16084	6.00	1.66	0.3670	0.275	0.44
6" EXTENSION SPIRAL POINT TAP	3	3B	3	16081		6.00	1.66	0.3670	0.275	0.44
8" EXTENSION HAND TAP	3	3B	4	17973	17974	8.00	1.66	0.3670	0.275	0.44
10" EXTENSION HAND TAP	3	3B	4	17978	17979	10.00	1.66	0.3670	0.275	0.44
12" EXTENSION HAND TAP	3	3B	4	17983	17984	12.00	1.66	0.3670	0.275	0.44
TRU-FLO FORM TAP	5	3B		19110	19111	3.38	0.94	0.3670	0.275	0.44
TRU-FLO FORM TAP	8	2B		19112	19113	3.38	0.94	0.3670	0.275	0.44
SOLID CARBIDE / HAND TAP	3	3B	4	41528	41529	3.38	0.94	0.3670	0.275	0.44
SOLID CARBIDE / SP PT TAP	3	3B	3	41530		3.38	0.94	0.3670	0.275	0.44
COST CUTTER DRILL/TAP	3	3B	2	29020		4.06	1.38	0.3670	0.275	0.44
TiN COAT/SP PT+.005 TAP	11	PLATING	3	50017		3.38	1.66	0.3670	0.275	0.44
TiN COAT HAND x 6" TAP	3	3B	4	50019		6.00	1.66	0.3670	0.275	0.44
TiN COAT/SP PT x 6" TAP	3	3B	3	50018		6.00	1.66	0.3670	0.275	0.44
STI HAND TAP	3	3B	4	17890	17891	3.81	1.81	0.4800	0.360	0.56
STI SPIRAL POINT TAP	3	3B	3	17892		3.81	1.81	0.4800	0.360	0.56
R.H. ROUND DIE 1-1/2"OD				13164						
L.H. ROUND DIE 1-1/2"OD				13165						
GAGE - Taperlock Style		2B		23163						
GAGE - Taperlock Style		3B		23164						
GAGE - Reversible Style		2B		24329						

TAPS, DIES & GAGES

Click on Item Number below for Price List

SIZE/ DESCRIPTION	GH #	CLASS OF FIT	# FLUTES	ITEM #		OVERALL LENGTH	THREAD LENGTH	SHANK DIAMETER	SQUARE DIAMETER	SQUARE LENGTH
				PLUG	BOTTOM					
<b>1/2"-13 NC</b>				<i>See Previous Page for Recommended Hole Size</i>						
GAGE - Reversible Style		3B		24330						
GAGE - Ring-Go		2A		23542						
GAGE - Ring-Go		3A		23543						
GAGE - Ring-NoGo		2A		23544						
GAGE - Ring-NoGo		3A		23545						
GAGE - STI Plug Taperlock Style		2B		24717						
GAGE - STI Plug Taperlock Style		3B		24718						
<b>1/2"-14 PIPE TAP NPSI NPSF NPT/F NPS</b>				<i>Recommended Hole Size: NPT/NPTF = .703" NPSF/NPSI = .7188"</i>						
NPT/F REG. SPR FLT TAPER TAP			4	16086		3.13	1.38	0.6875	0.515	0.63
NPT/F LEFT HAND TAPER TAP			4	16089		3.13	1.38	0.6875	0.515	0.63
NPT/F 6" EXTENSION TAPER TAP			4	16092		6.00	1.38	0.6875	0.515	0.63
NPT/F 6" EXTENSION INT TAPER TAP			5	16095		6.00	1.38	0.6875	0.515	0.63
NPSF EXT x 6" TAP			4	17720		6.00	1.38	0.6875	0.515	0.63
NPT/F 8" EXTENSION TAPER TAP			4	16098		8.00	1.38	0.6875	0.515	0.63
NPT/F 10" EXTENSION TAPER TAP			4	17987		10.00	1.38	0.6875	0.515	0.63
NPT/F CARB-I SERT TAP			4	41809		3.13	1.19	0.6875	0.515	0.63
NPT/F COST CUTTER DRILL/TAP			4	29044		4.38	1.38	0.6875	0.515	0.63
NPSI STRAIGHT TAP			4	16104		3.13	1.38	0.6875	0.515	0.63
NPT R.H. ROUND DIE 2"OD				13184						
NPS R.H. ROUND DIE 2"OD				13186						
GAGE L1 NPT PLG w/handle				24380						
GAGE L1 NPT RING				24378						
GAGE L1 NPTF PLG w/handle				24450						
GAGE L3 NPTF PLG w/handle				24452						
GAGE NPTF 6 step Plain Plug w/handle				24540						
GAGE L1 NPTF RING				24502						
GAGE L2 NPTF RING				24504						
GAGE NPTF 6 step Plain Ring				24574						
<b>1/2"-14 55° WHITWORTH PIPE</b>				<i>Recommended Hole Size: BSPT = .7188" / BSPP = .7344"</i>						
BSPT TAPER - MODIFIED TAP			4	16107	16108	3.13	1.38	0.6875	0.515	0.63
BSPP PARALLEL - MODIFIED TAP			4	16110	16111	3.13	1.38	0.6875	0.515	0.63
BSPT TAPER - FULL FORM TAP			4	17935		3.13	1.38	0.6875	0.515	0.63
BSPP PARALLEL - FULL FORM TAP			4	17926		3.13	1.38	0.6875	0.515	0.63
BSPT FULL FORM DIE 2"OD				13698						
BSPP FULL FORM DIE 2"OD				13699						
GAGE BSPT-Mod. w/handle				27011						
GAGE BSPP-Mod. DBL END w/handle				27050						



Click on Item Number  
below for Price List

SIZE/ DESCRIPTION	GH #	CLASS OF FIT	# FLUTES	ITEM #		OVERALL LENGTH	THREAD LENGTH	SHANK DIAMETER	SQUARE DIAMETER	SQUARE LENGTH
				PLUG	BOTTOM					
<b>1/2"-14 NS</b>						<i>Recommended Hole Size based on 75% Thread = .4306"</i>				
HAND TAP	3	3B	4	16115	16116	3.38	1.66	0.3670	0.275	0.44
R.H. ROUND DIE 1-1/2"OD				13166						
<b>1/2"-16 NS</b>						<i>Recommended Hole Size based on 75% Thread = .4394"</i>				
HAND TAP	3	3B	4	16120	16121	3.38	1.66	0.3670	0.275	0.44
R.H. ROUND DIE 1-1/2"OD				13168						
GAGE - Taperlock Style		2B		22259						
GAGE - Taperlock Style		3B		22260						
GAGE - Ring-Go		2A		22261						
GAGE - Ring-Go		3A		22262						
GAGE - Ring-NoGo		2A		22263						
GAGE - Ring-NoGo		3A		22264						
<b>1/2"-18 NS</b>						<i>Recommended Hole Size based on 75% Thread = .4464"</i>				
HAND TAP	3	3B	4	16125	16126	3.38	1.66	0.3670	0.275	0.44
R.H. ROUND DIE 1-1/2"OD				13170						
<b>1/2"-20 NF</b>						<i>Recommended Hole Size based on 75% Thread = .4515" for STI = .5156" / TRU-FLO at 65% Thread = .4779"</i>				
L.H. HAND TAP	3	3B	4	16130	16131	3.38	1.66	0.3670	0.275	0.44
L.H. SPIRAL POINT TAP	3	3B	3	16128		3.38	1.66	0.3670	0.275	0.44
HAND TAP	5	2B	4		17634	3.38	1.66	0.3670	0.275	0.44
+.003 HAND TAP	7		4	16135	16136	3.38	1.66	0.3670	0.275	0.44
+.005 HAND TAP	11	PLATING	4	16140	16141	3.38	1.66	0.3670	0.275	0.44
+.005 SPIRAL POINT TAP	11	PLATING	3	16138		3.38	1.66	0.3670	0.275	0.44
6" PULLEY TAP	3	3B	4	16145	16146	6.00	1.66	0.5070	0.380	0.56
6" EXTENSION HAND TAP	3	3B	4	16150	16151	6.00	1.66	0.3670	0.275	0.44
6" EXTENSION SPIRAL POINT TAP	3	3B	3	16148		6.00	1.66	0.3670	0.275	0.44
TRU-FLO FORM TAP	5	3B		19114	19115	3.38	0.94	0.3670	0.275	0.44
TRU-FLO FORM TAP	8	2B		19116	19117	3.38	0.94	0.3670	0.275	0.44
TRU-FLO FORM TAP	10	PLATING		19118	19119	3.38	0.94	0.3670	0.275	0.44
SOLID CARBIDE / HAND TAP	3	3B	4	41532	41533	3.38	0.94	0.3670	0.275	0.44
SOLID CARBIDE / SP PT TAP	3	3B	3	41534		3.38	0.94	0.3670	0.275	0.44
COST CUTTER DRILL/TAP	3	3B	2	29022		4.06	1.38	0.3670	0.275	0.44
STI HAND TAP	3	3B	4	17894	17895	3.59	1.66	0.4290	0.322	0.50
STI SPIRAL POINT TAP	3	3B	3	17896		3.59	1.66	0.4290	0.322	0.50
R.H. ROUND DIE 1-1/2"OD				13172						
L.H. ROUND DIE 1-1/2"OD				13173						
GAGE - Taperlock Style		2B		23168						
GAGE - Taperlock Style		3B		23169						
GAGE - Reversible Style		2B		24334						
GAGE - Reversible Style		3B		24335						
GAGE - Ring-Go		2A		23548						
GAGE - Ring-Go		3A		23549						
GAGE - Ring-NoGo		2A		23550						
GAGE - Ring-NoGo		3A		23551						
GAGE - STI Plug Taperlock Style		2B		24722						
GAGE - STI Plug Taperlock Style		3B		24723						

TAPS, DIES & GAGES

Click on Item Number below for Price List

SIZE/ DESCRIPTION	GH #	CLASS OF FIT	# FLUTES	ITEM #		OVERALL LENGTH	THREAD LENGTH	SHANK DIAMETER	SQUARE DIAMETER	SQUARE LENGTH
				PLUG	BOTTOM					
<b>1/2"-24 NS</b>						<i>Recommended Hole Size based on 75% Thread = .459"</i>				
HAND TAP	3	3B	4	16155	16156	3.38	1.66	0.3670	0.275	0.44
R.H. ROUND DIE 1-1/2"OD				13174						
<b>1/2"-27 NS</b>						<i>Recommended Hole Size based on 75% Thread = .464"</i>				
HAND TAP	3	3B	4	16160	16161	3.38	1.66	0.3670	0.275	0.44
R.H. ROUND DIE 1-1/2"OD				13176						
<b>1/2"-28 NEF</b>						<i>Recommended Hole Size based on 75% Thread = .4653"</i>				
HAND TAP	3	3B	4	16165	16166	3.38	1.66	0.3670	0.275	0.44
SPIRAL POINT TAP	3	3B	3	16163		3.38	1.66	0.3670	0.275	0.44
HAND TAP	5	2B	4	16170	16171	3.38	1.66	0.3670	0.275	0.44
R.H. ROUND DIE 1-1/2"OD				13178						
GAGE - Taperlock Style		2B		23173						
GAGE - Taperlock Style		3B		23174						
GAGE - Reversible Style		2B		24957						
GAGE - Reversible Style		3B		24958						
GAGE - Ring-Go		2A		23554						
GAGE - Ring-Go		3A		23555						
GAGE - Ring-NoGo		2A		23556						
GAGE - Ring-NoGo		3A		23557						
<b>1/2"-32 NS</b>						<i>Recommended Hole Size based on 75% Thread = .4697"</i>				
HAND TAP	3	3B	6	16175	16176	3.38	1.66	0.3670	0.275	0.44
R.H. ROUND DIE 1-1/2"OD				13180						
GAGE - Taperlock Style		2B		22273						
GAGE - Taperlock Style		3B		22274						
GAGE - Ring-Go		2A		22275						
GAGE - Ring-Go		3A		22276						
GAGE - Ring-NoGo		2A		22277						
GAGE - Ring-NoGo		3A		22278						
<b>1/2"-40 NS</b>						<i>Recommended Hole Size based on 75% Thread = .4758"</i>				
HAND TAP	2	3B	6	16180	16181	3.38	1.66	0.3670	0.275	0.44
R.H. ROUND DIE 1-1/2"OD				13182						
<b>33/64"-13 NS</b>						<i>Recommended Hole Size based on 75% Thread = .4407"</i>				
HAND TAP	3	3B	4	16185	16186	3.59	1.66	0.4290	0.322	0.50
<b>9/16"-12 NC</b>						<i>Recommended Hole Size based on 75% Thread = .4817" TRU-FLO at 65% Thread = .5257"</i>				
L.H. HAND TAP	3	3B	4	16190	16191	3.59	1.66	0.4290	0.322	0.50
SPIRAL POINT TAP	3	3B	3	18331		3.59	1.66	0.4290	0.322	0.50
6" EXTENSION HAND TAP	3	3B	4	17653	17654	6.00	1.66	0.4290	0.322	0.50
TRU-FLO FORM TAP	7	3B		19120	19121	3.59	1.00	0.4290	0.322	0.50
TRU-FLO FORM TAP	10	2B		19122	19123	3.59	1.00	0.4290	0.322	0.50
SOLID CARBIDE TAP	3	3B	4	47201	47202	3.59	1.00	0.4290	0.322	0.50
R.H. ROUND DIE 1-1/2"OD				13188						
L.H. ROUND DIE 1-1/2"OD				13189						
GAGE - Taperlock Style		2B		23178						
GAGE - Taperlock Style		3B		23179						
GAGE - Reversible Style		2B		24339						
GAGE - Reversible Style		3B		24340						



SIZE/ DESCRIPTION	GH #	CLASS OF FIT	# FLUTES	Click on Item Number below for Price List		OVERALL LENGTH	THREAD LENGTH	SHANK DIAMETER	SQUARE DIAMETER	SQUARE LENGTH
				ITEM #						
				PLUG	BOTTOM					
<b>9/16"-12 NC</b>										
<i>See Previous Page for Recommended Hole Size</i>										
GAGE - Ring-Go		2A		23560						
GAGE - Ring-Go		3A		23561						
GAGE - Ring-NoGo		2A		23562						
GAGE - Ring-NoGo		3A		23563						
GAGE - STI Plug Taperlock Style		2B		22279						
GAGE - STI Plug Taperlock Style		3B		22280						
<b>9/16"-16 NS</b>										
<i>Recommended Hole Size based on 75% Thread = .5019"</i>										
<b>HAND TAP</b>	<b>3</b>	<b>3B</b>	<b>4</b>	<b>16200</b>	<b>16201</b>	<b>3.59</b>	<b>1.66</b>	<b>0.4290</b>	<b>0.322</b>	<b>0.50</b>
R.H. ROUND DIE 1-1/2"OD				13190						
GAGE - Taperlock Style		2B		22289						
GAGE - Taperlock Style		3B		22290						
GAGE - Ring-Go		2A		22291						
GAGE - Ring-Go		3A		22292						
GAGE - Ring-NoGo		2A		22293						
GAGE - Ring-NoGo		3A		22294						
<b>9/16"-18 NF</b>										
<i>Recommended Hole Size based on 75% Thread = .5089" TRU-FLO at 65% Thread = .5279"</i>										
<b>L.H. HAND TAP</b>	<b>3</b>	<b>3B</b>	<b>4</b>	<b>16205</b>	<b>16206</b>	<b>3.59</b>	<b>1.66</b>	<b>0.4290</b>	<b>0.322</b>	<b>0.50</b>
<b>SPIRAL POINT TAP</b>	<b>3</b>	<b>3B</b>	<b>3</b>	<b>18337</b>		<b>3.59</b>	<b>1.66</b>	<b>0.4290</b>	<b>0.322</b>	<b>0.50</b>
<b>HAND TAP</b>	<b>5</b>	<b>2B</b>	<b>4</b>	<b>18375</b>	<b>17769</b>	<b>3.59</b>	<b>1.66</b>	<b>0.4290</b>	<b>0.322</b>	<b>0.50</b>
<b>SPIRAL POINT TAP</b>	<b>5</b>	<b>2B</b>	<b>3</b>	<b>17655</b>		<b>3.59</b>	<b>1.66</b>	<b>0.4290</b>	<b>0.322</b>	<b>0.50</b>
<b>+.005 HAND TAP</b>	<b>11</b>	<b>PLATING</b>	<b>4</b>	<b>16215</b>	<b>16216</b>	<b>3.59</b>	<b>1.66</b>	<b>0.4290</b>	<b>0.322</b>	<b>0.50</b>
<b>+.005 SPIRAL POINT TAP</b>	<b>11</b>	<b>PLATING</b>	<b>3</b>	<b>16213</b>		<b>3.59</b>	<b>1.66</b>	<b>0.4290</b>	<b>0.322</b>	<b>0.50</b>
<b>6" EXTENSION HAND TAP</b>	<b>3</b>	<b>3B</b>	<b>4</b>	<b>16220</b>	<b>16221</b>	<b>6.00</b>	<b>1.66</b>	<b>0.4290</b>	<b>0.322</b>	<b>0.50</b>
<b>TRU-FLO FORM TAP</b>	<b>7</b>	<b>3B</b>		<b>19124</b>	<b>19125</b>	<b>3.59</b>	<b>1.00</b>	<b>0.4290</b>	<b>0.322</b>	<b>0.50</b>
<b>TRU-FLO FORM TAP</b>	<b>10</b>	<b>2B</b>		<b>19126</b>	<b>19127</b>	<b>3.59</b>	<b>1.00</b>	<b>0.4290</b>	<b>0.322</b>	<b>0.50</b>
<b>SOLID CARBIDE TAP</b>	<b>3</b>	<b>3B</b>	<b>4</b>	<b>47204</b>	<b>47205</b>	<b>3.59</b>	<b>1.00</b>	<b>0.4290</b>	<b>0.322</b>	<b>0.50</b>
R.H. ROUND DIE 1-1/2"OD				13192						
L.H. ROUND DIE 1-1/2"OD				13193						
GAGE - Taperlock Style		2B		23183						
GAGE - Taperlock Style		3B		23184						
GAGE - Reversible Style		2B		24344						
GAGE - Reversible Style		3B		24345						
GAGE - Ring-Go		2A		23566						
GAGE - Ring-Go		3A		23567						
GAGE - Ring-NoGo		2A		23568						
GAGE - Ring-NoGo		3A		23569						
GAGE - STI Plug Taperlock Style		2B		22295						
GAGE - STI Plug Taperlock		3B		22296						
<b>9/16"-20 NS</b>										
<i>Recommended Hole Size based on 75% Thread = .514"</i>										
<b>HAND TAP</b>	<b>3</b>	<b>3B</b>	<b>4</b>	<b>16225</b>	<b>16226</b>	<b>3.59</b>	<b>1.66</b>	<b>0.4290</b>	<b>0.322</b>	<b>0.50</b>
<b>SPIRAL POINT TAP</b>	<b>3</b>	<b>3B</b>	<b>3</b>	<b>16223</b>		<b>3.59</b>	<b>1.66</b>	<b>0.4290</b>	<b>0.322</b>	<b>0.50</b>
R.H. ROUND DIE 1-1/2"OD				13194						
GAGE - Taperlock Style		2B		22305						
GAGE - Taperlock Style		3B		22306						
GAGE - Ring-Go		2A		22307						
GAGE - Ring-Go		3A		22308						



TAPS, DIES & GAGES

Click on Item Number below for Price List

SIZE/ DESCRIPTION	GH #	CLASS OF FIT	# FLUTES	ITEM #		OVERALL LENGTH	THREAD LENGTH	SHANK DIAMETER	SQUARE DIAMETER	SQUARE LENGTH
				PLUG	BOTTOM					
<b>9/16"-20 NS</b>						<i>See Previous Page for Recommended Hole Size</i>				
GAGE - Ring-NoGo		2A		22309						
GAGE - Ring-NoGo		3A		22310						
<b>9/16"-24 NEF</b>						<i>Recommended Hole Size based on 75% Thread = .5215"</i>				
HAND TAP	3	3B	4	16230	16231	3.59	1.66	0.4290	0.322	0.50
HAND TAP	5	2B	4	16235	16236	3.59	1.66	0.4290	0.322	0.50
R.H. ROUND DIE 1-1/2"OD				13196						
GAGE - Taperlock Style		2B		23188						
GAGE - Taperlock Style		3B		23189						
GAGE - Reversible Style		2B		24962						
GAGE - Reversible Style		3B		24963						
GAGE - Ring-Go		2A		23572						
GAGE - Ring-Go		3A		23573						
GAGE - Ring-NoGo		2A		23574						
GAGE - Ring-NoGo		3A		23575						
<b>9/16"-27 NS</b>						<i>Recommended Hole Size based on 75% Thread = .5265"</i>				
HAND TAP	3	3B	6	16240	16241	3.59	1.66	0.4290	0.322	0.50
R.H. ROUND DIE 1-1/2"OD				13198						
<b>9/16"-32 NS</b>						<i>Recommended Hole Size based on 75% Thread = .5322"</i>				
HAND TAP	3	3B	6	16245	16246	3.59	1.66	0.4290	0.322	0.50
R.H. ROUND DIE 1-1/2"OD				13200						
GAGE - Taperlock Style		2B		22311						
GAGE - Taperlock Style		3B		22312						
GAGE - Ring-Go		2A		22313						
GAGE - Ring-Go		3A		22314						
GAGE - Ring-NoGo		2A		22315						
GAGE - Ring-NoGo		3A		22316						
<b>5/8"-8 ACME</b>						<i>Recommended Hole Size = .5000"</i>				
HAND TAP		2G	4	16249		3.81	1.81	0.4800	0.360	0.56
L.H. HAND TAP		2G	4	16253		3.81	1.81	0.4800	0.360	0.56
TANDEM TAP		2G	4	16255		6.25	3.19	0.4800	0.360	0.56
L.H. TANDEM TAP		2G	4	16256		6.25	3.19	0.4800	0.360	0.56
<b>5/8"-11 NC</b>						<i>Recommended Hole Size based on 75% Thread = .5365" TRU-FLO at 65% Thread = .5848"</i>				
REGULAR SPIRAL FLUTE TAP	3	3B	4	16284	16285	3.81	1.81	0.4800	0.360	0.56
FAST SPIRAL FLUTE TAP	3	3B	4	17717	17718	3.81	1.81	0.4800	0.360	0.56
L.H. HAND TAP	3	3B	4	16270	16271	3.81	1.81	0.4800	0.360	0.56
L.H. SPIRAL POINT TAP	3	3B	3	16268		3.81	1.81	0.4800	0.360	0.56
+.005 HAND TAP	11	PLATING	4	16275	16276	3.81	1.81	0.4800	0.360	0.56
+.005 SPIRAL POINT TAP	11	PLATING	3	16273		3.81	1.81	0.4800	0.360	0.56
+.010 HAND TAP	21		4	16280	16281	3.81	1.81	0.4800	0.360	0.56
6" EXTENSION HAND TAP	3	3B	4	16309	16310	6.00	1.81	0.4800	0.360	0.56
6" EXTENSION SPIRAL POINT TAP	3	3B	3	16307		6.00	1.81	0.4800	0.360	0.56
8" EXTENSION HAND TAP	3	3B	4	16314	16315	8.00	1.81	0.4800	0.360	0.56
10" EXTENSION HAND TAP	3	3B	4	17991	17992	10.00	1.81	0.4800	0.360	0.56
12" EXTENSION HAND TAP	3	3B	4	17996	17997	12.00	1.81	0.4800	0.360	0.56



SIZE/ DESCRIPTION	GH #	CLASS OF FIT	# FLUTES	ITEM #		OVERALL LENGTH	THREAD LENGTH	SHANK DIAMETER	SQUARE DIAMETER	SQUARE LENGTH
				Click on Item Number below for Price List						
				PLUG	BOTTOM					
<b>5/8"-11 NC</b>				<i>See Previous Page for Recommended Hole Size</i>						
TRU-FLO FORM TAP	7	3B		19128	19129	3.81	1.09	0.4800	0.360	0.56
TRU-FLO FORM TAP	10	2B		19130	19131	3.81	1.09	0.4800	0.360	0.56
COST CUTTER DRILL/TAP	3	3B	4	29036		5.06	1.75	0.4800	0.360	0.56
SOLID CARBIDE TAP	3	3B	4	47207	47208	3.81	1.09	0.4800	0.360	0.56
TiN COAT/SP PT x 6" TAP	3	3B	3	50020		6.00	1.81	0.4800	0.360	0.56
R.H. ROUND DIE 1-1/2"OD				13204						
L.H. ROUND DIE 1-1/2"OD				13205						
GAGE - Taperlock Style		2B		23193						
GAGE - Taperlock Style		3B		23194						
GAGE - Reversible Style		2B		24349						
GAGE - Reversible Style		3B		24350						
GAGE - Ring-Go		2A		23578						
GAGE - Ring-Go		3A		23579						
GAGE - Ring-NoGo		2A		23580						
GAGE - Ring-NoGo		3A		23581						
GAGE - STI Plug Taperlock Style		2B		24737						
GAGE - STI Plug Taperlock Style		3B		24738						
<b>5/8"-11 BSW 55° MOD WHITWORTH</b>				<i>Recommended Hole Size = .5377"</i>						
	3		4	16265	16266	3.81	1.81	0.4800	0.360	0.56
<b>5/8"-12 NS</b>				<i>Recommended Hole Size based on 75% Thread = .5442"</i>						
HAND TAP	3	3B	4	16320	16321	3.81	1.81	0.4800	0.360	0.56
GAGE - Taperlock Style		2B		22323						
GAGE - Taperlock Style		3B		22324						
GAGE - Ring-Go		2A		22325						
GAGE - Ring-Go		3A		22326						
GAGE - Ring-NoGo		2A		22327						
GAGE - Ring-NoGo		3A		22328						
<b>5/8"-16 NS</b>				<i>Recommended Hole Size based on 75% Thread = .5644"</i>						
HAND TAP	3	3B	4	16325	16326	3.81	1.81	0.4800	0.360	0.56
GAGE - Taperlock Style		2B		22329						
GAGE - Taperlock Style		3B		22330						
GAGE - Ring-Go		2A		22331						
GAGE - Ring-Go		3A		22332						
GAGE - Ring-NoGo		2A		22333						
GAGE - Ring-NoGo		3A		22334						
<b>5/8"-18 NF</b>				<i>Recommended Hole Size based on 75% Thread = .5714" TRU-FLO at 65% Thread = .6004"</i>						
REGULAR SPIRAL FLUTE TAP	3	3B	4	16339	16340	3.81	1.81	0.4800	0.360	0.56
FAST SPIRAL FLUTE TAP	3	3B	4	17727	17728	3.81	1.81	0.4800	0.360	0.56
L.H. HAND TAP	3	3B	4	16330	16331	3.81	1.81	0.4800	0.360	0.56
SPIRAL POINT TAP	3	3B	3	18353		3.81	1.81	0.4800	0.360	0.56
SPIRAL POINT TAP	5	2B	3	17683		3.81	1.81	0.4800	0.360	0.56
+.003 HAND TAP	7		4	17681	17682	3.81	1.81	0.4800	0.360	0.56
HAND TAP	8		4	17904	17905	3.81	1.81	0.4800	0.360	0.56
+.005 HAND TAP	11	PLATING	4	16335	16336	3.81	1.81	0.4800	0.360	0.56
6" EXTENSION HAND TAP	3	3B	4	16344	16345	6.00	1.81	0.4800	0.360	0.56

TAPS, DIES & GAGES

Click on Item Number below for Price List

SIZE/ DESCRIPTION	GH #	CLASS OF FIT	# FLUTES	ITEM #		OVERALL LENGTH	THREAD LENGTH	SHANK DIAMETER	SQUARE DIAMETER	SQUARE LENGTH
				PLUG	BOTTOM					
<b>5/8"-18 NF</b>						<i>See Previous Page for Recommended Hole Size</i>				
TRU-FLO FORM TAP	7	3B		19132	19133	3.81	1.09	0.4800	0.360	0.56
TRU-FLO FORM TAP	10	2B		19134	19135	3.81	1.09	0.4800	0.360	0.56
SOLID CARBIDE TAP	3	3B	4	47210	47211	3.81	1.09	0.4800	0.360	0.56
TiN COAT/FAST SP FLT TAP	3	3B	4		50032	3.81	1.81	0.4800	0.360	0.56
TiN COAT/SP PT TAP	5	2B	3	50028		3.81	1.81	0.4800	0.360	0.56
R.H. ROUND DIE 1-1/2"OD				13212						
L.H. ROUND DIE 1-1/2"OD				13213						
GAGE - Taperlock Style		2B		23198						
GAGE - Taperlock Style		3B		23199						
GAGE - Reversible Style		2B		24354						
GAGE - Reversible Style		3B		24355						
GAGE - Ring-Go		2A		23584						
GAGE - Ring-Go		3A		23585						
GAGE - Ring-NoGo		2A		23586						
GAGE - Ring-NoGo		3A		23587						
GAGE - STI Plug Taperlock Style		2B		24742						
GAGE - STI Plug Taperlock Style		3B		24743						
<b>5/8"-20 NS</b>						<i>Recommended Hole Size based on 75% Thread = .5765"</i>				
HAND TAP	3	3B	4	16349	16350	3.81	1.81	0.4800	0.360	0.56
R.H. ROUND DIE 1-1/2"OD				13214						
GAGE - Taperlock Style		2B		22343						
GAGE - Taperlock Style		3B		22344						
GAGE - Ring-Go		2A		22345						
GAGE - Ring-Go		3A		22346						
GAGE - Ring-NoGo		2A		22347						
GAGE - Ring-NoGo		3A		22348						
<b>5/8"-24 NEF</b>						<i>Recommended Hole Size based on 75% Thread = .5840"</i>				
HAND TAP	3	3B	6	16354	16355	3.81	1.81	0.4800	0.360	0.56
HAND TAP	5	2B	6	16359	16360	3.81	1.81	0.4800	0.360	0.56
R.H. ROUND DIE 1-1/2"OD				13216						
GAGE - Taperlock Style		2B		23203						
GAGE - Taperlock Style		3B		23204						
GAGE - Reversible Style		2B		24967						
GAGE - Reversible Style		3B		24968						
GAGE - Ring-Go		2A		23590						
GAGE - Ring-Go		3A		23591						
GAGE - Ring-NoGo		2A		23592						
GAGE - Ring-NoGo		3A		23593						
<b>5/8"-27 NS</b>						<i>Recommended Hole Size based on 75% Thread = .5890"</i>				
HAND TAP	3	3B	6	16364	16365	3.81	1.81	0.4800	0.360	0.56
R.H. ROUND DIE 1-1/2"OD				13218						
<b>5/8"-28 NS</b>						<i>Recommended Hole Size based on 75% Thread = .5903"</i>				
HAND TAP	3	3B	6	16369	16370	3.81	1.81	0.4800	0.360	0.56
R.H. ROUND DIE 1-1/2"OD				13220						
GAGE - Taperlock Style		2B		22355						



SIZE/ DESCRIPTION	GH #	CLASS OF FIT	# FLUTES	Click on Item Number below for Price List		OVERALL LENGTH	THREAD LENGTH	SHANK DIAMETER	SQUARE DIAMETER	SQUARE LENGTH
				ITEM #						
				PLUG	BOTTOM					
<b>5/8"-28 NS</b>				<i>See Previous Page for Recommended Hole Size</i>						
GAGE - Taperlock Style		3B		22356						
GAGE - Ring-Go		2A		22357						
GAGE - Ring-Go		3A		22358						
GAGE - Ring-NoGo		2A		22359						
GAGE - Ring-NoGo		3A		22360						
<b>5/8"-32 NS</b>				<i>Recommended Hole Size based on 75% Thread = .5947"</i>						
<b>HAND TAP</b>	<b>3</b>	<b>3B</b>	<b>6</b>	<b>16374</b>	<b>16375</b>	<b>3.81</b>	<b>1.81</b>	<b>0.4800</b>	<b>0.360</b>	<b>0.56</b>
R.H. ROUND DIE 1-1/2"OD				13222						
GAGE - Taperlock Style		2B		22361						
GAGE - Taperlock Style		3B		22362						
GAGE - Ring-Go		2A		22363						
GAGE - Ring-Go		3A		22364						
GAGE - Ring-NoGo		2A		22365						
GAGE - Ring-NoGo		3A		22366						
<b>41/64"-11 NS</b>				<i>Recommended Hole Size based on 75% Thread = .5521"</i>						
<b>HAND TAP</b>	<b>4</b>	<b>3B</b>	<b>4</b>	<b>16379</b>	<b>16380</b>	<b>4.03</b>	<b>1.81</b>	<b>0.5420</b>	<b>0.406</b>	<b>0.63</b>
<b>11/16"-11 NS</b>				<i>Recommended Hole Size based on 75% Thread = .5990"</i>						
<b>L.H. HAND TAP</b>	<b>3</b>	<b>3B</b>	<b>4</b>	<b>16384</b>	<b>16385</b>	<b>4.03</b>	<b>1.81</b>	<b>0.5420</b>	<b>0.406</b>	<b>0.63</b>
<b>11/16"-16 NS</b>				<i>Recommended Hole Size based on 75% Thread = .6269"</i>						
<b>L.H. HAND TAP</b>	<b>3</b>	<b>3B</b>	<b>4</b>	<b>16389</b>	<b>16390</b>	<b>4.03</b>	<b>1.81</b>	<b>0.5420</b>	<b>0.406</b>	<b>0.63</b>
L.H. ROUND DIE 2"OD				13229						
GAGE - Taperlock Style		2B		22367						
GAGE - Taperlock Style		3B		22368						
GAGE - Ring-Go		2A		22369						
GAGE - Ring-Go		3A		22370						
GAGE - Ring-NoGo		2A		22371						
GAGE - Ring-NoGo		3A		22372						
<b>11/16"-18 NS</b>				<i>Recommended Hole Size based on 75% Thread = .6339"</i>						
<b>L.H. HAND TAP</b>	<b>3</b>	<b>3B</b>	<b>4</b>	<b>17576</b>	<b>17577</b>	<b>4.03</b>	<b>1.81</b>	<b>0.5420</b>	<b>0.406</b>	<b>0.63</b>
<b>HAND TAP</b>	<b>3</b>	<b>3B</b>	<b>4</b>	<b>16394</b>	<b>16395</b>	<b>4.03</b>	<b>1.81</b>	<b>0.5420</b>	<b>0.406</b>	<b>0.63</b>
R.H. ROUND DIE 2"OD				13230						
<b>11/16"-20 NS</b>				<i>Recommended Hole Size based on 75% Thread = .6390"</i>						
<b>HAND TAP</b>	<b>3</b>	<b>3B</b>	<b>6</b>	<b>16399</b>	<b>16400</b>	<b>4.03</b>	<b>1.81</b>	<b>0.5420</b>	<b>0.406</b>	<b>0.63</b>
R.H. ROUND DIE 2"OD				13232						
GAGE - Taperlock Style		2B		22373						
GAGE - Taperlock Style		3B		22374						
GAGE - Ring-Go		2A		22375						
GAGE - Ring-Go		3A		22376						
GAGE - Ring-NoGo		2A		22377						
GAGE - Ring-NoGo		3A		22378						
<b>11/16"-24 NEF</b>				<i>Recommended Hole Size based on 75% Thread = .6465"</i>						
<b>HAND TAP</b>	<b>3</b>	<b>3B</b>	<b>6</b>	<b>16404</b>	<b>16405</b>	<b>4.03</b>	<b>1.81</b>	<b>0.5420</b>	<b>0.406</b>	<b>0.63</b>
<b>HAND TAP</b>	<b>5</b>	<b>2B</b>	<b>6</b>	<b>16409</b>	<b>16410</b>	<b>4.03</b>	<b>1.81</b>	<b>0.5420</b>	<b>0.406</b>	<b>0.63</b>
R.H. ROUND DIE 2"OD				13234						
GAGE - Taperlock Style		2B		23208						

TAPS, DIES & GAGES

Click on Item Number below for Price List

SIZE/ DESCRIPTION	GH #	CLASS OF FIT	# FLUTES	ITEM #		OVERALL LENGTH	THREAD LENGTH	SHANK DIAMETER	SQUARE DIAMETER	SQUARE LENGTH
				PLUG	BOTTOM					
<b>11/16"-24 NEF</b>						<i>See Previous Page for Recommended Hole Size</i>				
GAGE - Taperlock Style		3B		23209						
GAGE - Reversible Style		2B		24972						
GAGE - Reversible Style		3B		24973						
GAGE - Ring-Go		2A		23596						
GAGE - Ring-Go		3A		23597						
GAGE - Ring-NoGo		2A		23598						
GAGE - Ring-NoGo		3A		23599						
<b>11/16"-28 NS</b>						<i>Recommended Hole Size based on 75% Thread = .6528"</i>				
<b>HAND TAP</b>	<b>3</b>	<b>3B</b>	<b>6</b>	<b>16419</b>	<b>16420</b>	<b>4.03</b>	<b>1.81</b>	<b>0.5420</b>	<b>0.406</b>	<b>0.63</b>
GAGE - Taperlock Style		2B		22379						
GAGE - Taperlock Style		3B		22380						
GAGE - Ring-Go		2A		22381						
GAGE - Ring-Go		3A		22382						
GAGE - Ring-NoGo		2A		22383						
GAGE - Ring-NoGo		3A		22384						
<b>11/16"-32 NS</b>						<i>Recommended Hole Size based on 75% Thread = .6572"</i>				
<b>HAND TAP</b>	<b>3</b>	<b>3B</b>	<b>6</b>	<b>16424</b>	<b>16425</b>	<b>4.03</b>	<b>1.81</b>	<b>0.5420</b>	<b>0.406</b>	<b>0.63</b>
R.H. ROUND DIE 2"OD				13238						
GAGE - Taperlock Style		2B		22385						
GAGE - Taperlock Style		3B		22386						
GAGE - Ring-Go		2A		22387						
GAGE - Ring-Go		3A		22388						
GAGE - Ring-NoGo		2A		22389						
GAGE - Ring-NoGo		3A		22390						
<b>3/4"-5 ACME</b>						<i>Recommended Hole Size = .550"</i>				
<b>HAND TAP</b>		<b>2G</b>	<b>4</b>	<b>18102</b>	<b>18103</b>	<b>4.25</b>	<b>2.00</b>	<b>0.5900</b>	<b>0.442</b>	<b>0.69</b>
<b>3/4"-6 ACME</b>						<i>Recommended Hole Size = .5833"</i>				
<b>HAND TAP</b>		<b>2G</b>	<b>4</b>	<b>16432</b>		<b>4.25</b>	<b>2.00</b>	<b>0.5900</b>	<b>0.442</b>	<b>0.69</b>
<b>L.H. HAND TAP</b>		<b>2G</b>	<b>4</b>	<b>16436</b>		<b>4.25</b>	<b>2.00</b>	<b>0.5900</b>	<b>0.442</b>	<b>0.69</b>
<b>TANDEM TAP</b>		<b>2G</b>	<b>4</b>	<b>16438</b>		<b>7.94</b>	<b>4.31</b>	<b>0.5420</b>	<b>0.406</b>	<b>0.63</b>
<b>L.H. TANDEM TAP</b>		<b>2G</b>	<b>4</b>	<b>16439</b>		<b>7.94</b>	<b>4.31</b>	<b>0.5420</b>	<b>0.406</b>	<b>0.63</b>
<b>3/4"-8 ACME</b>						<i>Recommended Hole Size = .625"</i>				
<b>HAND TAP</b>		<b>2G</b>	<b>4</b>	<b>16442</b>		<b>4.25</b>	<b>2.00</b>	<b>0.5900</b>	<b>0.442</b>	<b>0.69</b>
<b>TANDEM TAP</b>		<b>2G</b>	<b>4</b>	<b>16444</b>		<b>7.94</b>	<b>4.31</b>	<b>0.5420</b>	<b>0.406</b>	<b>0.63</b>
<b>L.H. TANDEM TAP</b>		<b>2G</b>	<b>4</b>	<b>16445</b>		<b>7.94</b>	<b>4.31</b>	<b>0.5420</b>	<b>0.406</b>	<b>0.63</b>
<b>3/4"-10 NC</b>						<i>Recommended Hole Size based on 75% Thread = .6526" TRU-FLO at 65% Thread = .7058"</i>				
<b>REGULAR SPIRAL FLUTE TAP</b>	<b>3</b>	<b>3B</b>	<b>4</b>	<b>16463</b>	<b>16464</b>	<b>4.25</b>	<b>2.00</b>	<b>0.5900</b>	<b>0.442</b>	<b>0.69</b>
<b>L.H. HAND TAP</b>	<b>3</b>	<b>3B</b>	<b>4</b>	<b>16449</b>	<b>16450</b>	<b>4.25</b>	<b>2.00</b>	<b>0.5900</b>	<b>0.442</b>	<b>0.69</b>
<b>+.005 HAND TAP</b>	<b>11</b>	<b>PLATING</b>	<b>4</b>	<b>16454</b>	<b>16455</b>	<b>4.25</b>	<b>2.00</b>	<b>0.5900</b>	<b>0.442</b>	<b>0.69</b>
<b>+.005 SPIRAL POINT TAP</b>	<b>11</b>	<b>PLATING</b>	<b>3</b>	<b>16452</b>		<b>4.25</b>	<b>2.00</b>	<b>0.5900</b>	<b>0.442</b>	<b>0.69</b>
<b>+.010 HAND TAP</b>	<b>21</b>		<b>4</b>	<b>16459</b>	<b>16460</b>	<b>4.25</b>	<b>2.00</b>	<b>0.5900</b>	<b>0.442</b>	<b>0.69</b>
<b>6" EXTENSION HAND TAP</b>	<b>3</b>	<b>3B</b>	<b>4</b>	<b>16478</b>	<b>16479</b>	<b>6.00</b>	<b>2.00</b>	<b>0.5900</b>	<b>0.442</b>	<b>0.69</b>
<b>6" EXTENSION SP PT TAP</b>	<b>3</b>	<b>3B</b>	<b>3</b>	<b>17632</b>		<b>6.00</b>	<b>2.00</b>	<b>0.5900</b>	<b>0.442</b>	<b>0.69</b>
<b>8" EXTENSION HAND TAP</b>	<b>3</b>	<b>3B</b>	<b>4</b>	<b>16483</b>	<b>16484</b>	<b>8.00</b>	<b>2.00</b>	<b>0.5900</b>	<b>0.442</b>	<b>0.69</b>



Click on Item Number  
below for Price List

SIZE/ DESCRIPTION	GH #	CLASS OF FIT	# FLUTES	ITEM #		OVERALL LENGTH	THREAD LENGTH	SHANK DIAMETER	SQUARE DIAMETER	SQUARE LENGTH
				PLUG	BOTTOM					
<b>3/4"-10 NC</b>						<i>See Previous Page for Recommended Hole Size</i>				
10" EXTENSION HAND TAP	3	3B	4	16488	16489	10.00	2.00	0.5900	0.442	0.69
TRU-FLO FORM TAP	7	3B		19136	19137	4.25	1.22	0.5900	0.442	0.69
TRU-FLO FORM TAP	10	2B		19138	19139	4.25	1.22	0.5900	0.442	0.69
SOLID CARBIDE TAP	3	3B	4	47213	47214	4.25	1.22	0.5900	0.442	0.69
SOLID CARBIDE TAP	5	3B	4	47228	47229	4.25	1.22	0.5900	0.442	0.69
TiN COAT/SPPTx6" TAP	3	3B	3	50027		6.00	2.00	0.5900	0.442	0.69
R.H. ROUND DIE 2"OD				13240						
L.H. ROUND DIE 2"OD				13241						
GAGE - Taperlock Style		2B		23213						
GAGE - Taperlock Style		3B		23214						
GAGE - Reversible Style		2B		24359						
GAGE - Reversible Style		3B		24360						
GAGE - Ring-Go		2A		23602						
GAGE - Ring-Go		3A		23603						
GAGE - Ring-NoGo		2A		23604						
GAGE - Ring-NoGo		3A		23605						
GAGE - STI Plug Taperlock Style		2B		24747						
GAGE - STI Plug Taperlock Style		3B		24748						
<b>3/4"-10 ACME</b>						<i>Recommended Hole Size = .6500"</i>				
HAND TAP		2G	4	16493		4.25	2.00	0.5900	0.442	0.69
<b>3/4"-11.5 NH</b>						<i>Recommended Hole Size = .9688"</i>				
GARDEN HOSE TAP			6	16497	16498	4.00	1.50	0.8960	0.672	0.88
<b>3/4"-12 NS</b>						<i>Recommended Hole Size based on 75% Thread = .6692"</i>				
HAND TAP	4	3B	4	16502	16503	4.25	2.00	0.5900	0.442	0.69
R.H. ROUND DIE 2"OD				13242						
GAGE - Taperlock Style		2B		22400						
GAGE - Taperlock Style		3B		22401						
GAGE - Ring-Go		2A		22402						
GAGE - Ring-Go		3A		22403						
GAGE - Ring-NoGo		2A		22404						
GAGE - Ring-NoGo		3A		22405						
<b>3/4"-14 PIPE TAP NPSI NPSF NPT/F NPS</b>						<i>Recommended Hole Size: NPT = .9063" / NPTF = .9219" NPSI = .9283"</i>				
NPT/F REG. SPR FLT TAPER TAP			5	16505		3.25	1.38	0.9063	0.679	0.69
NPT/F LEFT HAND TAPER TAP			5	16508		3.25	1.38	0.9063	0.679	0.69
NPT/F 6" EXTENSION TAPER TAP			5	16511		6.00	1.38	0.9063	0.679	0.69
NPT/F 6" EXTENSION INT TAPER TAP			5	16514		6.00	1.38	0.9063	0.679	0.69
NPT/F 8" EXTENSION TAPER TAP			5	16517		8.00	1.38	0.9063	0.679	0.69
NPT/F 10" EXTENSION TAPER TAP			5	18105		10.00	1.38	0.9063	0.679	0.69
NPSI STRAIGHT TAP			5	16523		3.25	1.38	0.9063	0.679	0.69
NPT/F CARB-I-SERT TAP			4	41810		3.25	1.19	0.9063	0.679	0.69
NPT/F COST CUTTER DRILL/TAP			4	29045		4.56	1.38	0.9063	0.679	0.69
NPT R.H. ROUND DIE 2"OD				13258						

TAPS, DIES & GAGES

Click on Item Number below for Price List

SIZE/ DESCRIPTION	GH #	CLASS OF FIT	# FLUTES	ITEM #		OVERALL LENGTH	THREAD LENGTH	SHANK DIAMETER	SQUARE DIAMETER	SQUARE LENGTH
				PLUG	BOTTOM					
<b>3/4"-14 PIPE TAP NPSI NPSF NPT/F NPS</b>						<i>See Previous Page for Recommended Hole Size</i>				
NPS R.H. ROUND DIE 2"OD				13260						
GAGE L1 NPT PLG w/handle				24383						
GAGE L1 NPT RING				24381						
GAGE L1 NPTF PLG w/handle				24458						
GAGE L3 NPTF PLG w/handle				24460						
GAGE NPTF 6 step Plain Plug w/handle				24544						
GAGE L1 NPTF RING				24506						
GAGE L2 NPTF RING				24508						
GAGE NPTF 6 step Plain Ring				24578						
<b>3/4"-14 55° WHITWORTH PIPE</b>						<i>Recommended Hole Size: BSPT = .9219" / BSPP = .9531"</i>				
BSPT TAPER - MODIFIED TAP			5	16526	16527	3.25	1.38	0.9063	0.679	0.69
BSPP PARALLEL - MODIFIED TAP			5	16529	16530	3.25	1.38	0.9063	0.679	0.69
BSPT TAPER - FULL FORM TAP			5	17936		3.25	1.38	0.9063	0.679	0.69
BSPP PARALLEL - FULL FORM TAP			5	17927		3.25	1.38	0.9063	0.679	0.69
BSPT FULL FORM DIE 2 "OD				13700						
BSPP FULL FORM DIE 2 "OD				13701						
GAGE BSPT-Mod. w/handle				27014						
GAGE BSPP-Mod. DBL END w/handle				27053						
<b>3/4"-16 NF</b>						<i>Recommended Hole Size based on 75% Thread = .6894" TRU-FLO at 65% Thread = .7224"</i>				
REGULAR SPIRAL FLUTE TAP	3	3B	4	16543	16544	4.25	2.00	0.5900	0.442	0.69
L.H. HAND TAP	3	3B	4	16534	16535	4.25	2.00	0.5900	0.442	0.69
SPIRAL POINT TAP	3	3B	3	18374		4.25	2.00	0.5900	0.442	0.69
SPIRAL POINT TAP	5	2B	3	17692		4.25	2.00	0.5900	0.442	0.69
L.H. HAND TAP	5	2B	4	17788	17789	4.25	2.00	0.5900	0.442	0.69
+.003 HAND TAP	7		4	17637	17638	4.25	2.00	0.5900	0.442	0.69
HAND TAP	8		4	17745	17746	4.25	2.00	0.5900	0.442	0.69
+.005 HAND TAP	11	PLATING	4	16539	16540	4.25	2.00	0.5900	0.442	0.69
TRU-FLO FORM TAP	7	3B		19140	19141	4.25	1.22	0.5900	0.442	0.69
TRU-FLO FORM TAP	10	2B		19142	19143	4.25	1.22	0.5900	0.442	0.69
SOLID CARBIDE TAP	3	3B	4	47216	47217	4.25	1.22	0.5900	0.442	0.69
SOLID CARBIDE TAP	5	3B	4	47231	47232	4.25	1.22	0.5900	0.442	0.69
TiN COAT/HAND TAP	8		4	50033		4.25	2.00	0.5900	0.442	0.69
R.H. ROUND DIE 2"OD				13246						
L.H. ROUND DIE 2"OD				13247						
GAGE - Taperlock Style		2B		23218						
GAGE - Taperlock Style		3B		23219						
GAGE - Reversible Style		2B		24364						
GAGE - Reversible Style		3B		24365						
GAGE - Ring-Go		2A		23608						
GAGE - Ring-Go		3A		23609						
GAGE - Ring-NoGo		2A		23610						
GAGE - Ring-NoGo		3A		23611						





Click on Item Number  
below for Price List

SIZE/ DESCRIPTION	GH #	CLASS OF FIT	# FLUTES	ITEM #		OVERALL LENGTH	THREAD LENGTH	SHANK DIAMETER	SQUARE DIAMETER	SQUARE LENGTH
				PLUG	BOTTOM					
<b>3/4"-16 NF</b>						<i>See Previous Page for Recommended Hole Size</i>				
GAGE - STI Plug Taperlock Style		2B		24752						
GAGE - STI Plug Taperlock Style		3B		24753						
<b>3/4"-18 NS</b>						<i>Recommended Hole Size based on 75% Thread = .6964"</i>				
HAND TAP	3	3B	4	16548	16549	4.25	2.00	0.5900	0.442	0.69
R.H. ROUND DIE 2"OD				13248						
<b>3/4"-20 NEF</b>						<i>Recommended Hole Size based on 75% Thread = .7015"</i>				
L.H. HAND TAP	3	3B	6	17663	17664	4.25	2.00	0.5900	0.442	0.69
HAND TAP	3	3B	6	16553	16554	4.25	2.00	0.5900	0.442	0.69
HAND TAP	5	2B	6	16558	16559	4.25	2.00	0.5900	0.442	0.69
R.H. ROUND DIE 2"OD				13250						
GAGE - Taperlock Style		2B		23223						
GAGE - Taperlock Style		3B		23224						
GAGE - Reversible Style		2B		24977						
GAGE - Reversible Style		3B		24978						
GAGE - Ring-Go		2A		23614						
GAGE - Ring-Go		3A		23615						
GAGE - Ring-NoGo		2A		23616						
GAGE - Ring-NoGo		3A		23617						
<b>3/4"-24 NS</b>						<i>Recommended Hole Size based on 75% Thread = .709"</i>				
HAND TAP	3	3B	6	16563	16564	4.25	2.00	0.5900	0.442	0.69
R.H. ROUND DIE 2"OD				13252						
<b>3/4"-27 NS</b>						<i>Recommended Hole Size based on 75% Thread = .714"</i>				
HAND TAP	3	3B	6	16568	16569	4.25	2.00	0.5900	0.442	0.69
R.H. ROUND DIE 2"OD				13254						
<b>3/4"-32 NS</b>						<i>Recommended Hole Size based on 75% Thread = .7197"</i>				
HAND TAP	3	3B	6	16573	16574	4.25	2.00	0.5900	0.442	0.69
R.H. ROUND DIE 2"OD				13256						
GAGE - Taperlock Style		2B		22414						
GAGE - Taperlock Style		3B		22415						
GAGE - Ring-Go		2A		22416						
GAGE - Ring-Go		3A		22417						
GAGE - Ring-NoGo		2A		22418						
GAGE - Ring-NoGo		3A		22419						
<b>3/4"-40 NS</b>						<i>Recommended Hole Size based on 75% Thread = .7258"</i>				
HAND TAP	3	3B	6	16578	16579	4.25	2.00	0.5900	0.442	0.69
<b>49/64"-10 NS</b>						<i>Recommended Hole Size based on 75% Thread = .6682"</i>				
HAND TAP	4	3B	4	16583	16584	4.47	2.00	0.6520	0.489	0.69
<b>.800"-36 AMO MOD. WHITWORTH</b>						<i>Recommended Hole Size = .7644"</i>				
HAND TAP	2		6	16592	16593	4.47	2.00	0.6520	0.489	0.69
<b>13/16"-10 NS</b>						<i>Recommended Hole Size based on 75% Thread = .7151"</i>				
HAND TAP	4	3B	4	16597	16598	4.47	2.00	0.6520	0.489	0.69
<b>13/16"-12 NS</b>						<i>Recommended Hole Size based on 75% Thread = .7317"</i>				
HAND TAP	4	3B	4	16602	16603	4.47	2.00	0.6520	0.489	0.69
GAGE - Taperlock Style		2B		22420						

TAPS, DIES & GAGES

Click on Item Number below for Price List

SIZE/ DESCRIPTION	GH #	CLASS OF FIT	# FLUTES	ITEM #		OVERALL LENGTH	THREAD LENGTH	SHANK DIAMETER	SQUARE DIAMETER	SQUARE LENGTH
				PLUG	BOTTOM					
<b>13/16"-12 NS</b>						<i>See Previous Page for Recommended Hole Size</i>				
GAGE - Taperlock Style		3B		22421						
GAGE - Ring-Go		2A		22422						
GAGE - Ring-Go		3A		22423						
GAGE - Ring-NoGo		2A		22424						
GAGE - Ring-NoGo		3A		22425						
<b>13/16"-16 NS</b>						<i>Recommended Hole Size based on 75% Thread = .7519"</i>				
<b>HAND TAP</b>	<b>3</b>	<b>3B</b>	<b>4</b>	<b>16607</b>	<b>16608</b>	<b>4.47</b>	<b>2.00</b>	<b>0.6520</b>	<b>0.489</b>	<b>0.69</b>
R.H. ROUND DIE 2"OD				13264						
GAGE - Taperlock Style		2B		22426						
GAGE - Taperlock Style		3B		22427						
GAGE - Ring-Go		2A		22428						
GAGE - Ring-Go		3A		22429						
GAGE - Ring-NoGo		2A		22430						
GAGE - Ring-NoGo		3A		22431						
<b>13/16"-18 NS</b>						<i>Recommended Hole Size based on 75% Thread = .7589"</i>				
<b>HAND TAP</b>	<b>3</b>	<b>3B</b>	<b>4</b>	<b>16612</b>	<b>16613</b>	<b>4.47</b>	<b>2.00</b>	<b>0.6520</b>	<b>0.489</b>	<b>0.69</b>
R.H. ROUND DIE 2"OD				13266						
<b>13/16"-20 NEF</b>						<i>Recommended Hole Size based on 75% Thread = .7640"</i>				
<b>HAND TAP</b>	<b>3</b>	<b>3B</b>	<b>6</b>	<b>16617</b>	<b>16618</b>	<b>4.47</b>	<b>2.00</b>	<b>0.6520</b>	<b>0.489</b>	<b>0.69</b>
<b>HAND TAP</b>	<b>5</b>	<b>2B</b>	<b>6</b>	<b>16622</b>	<b>16623</b>	<b>4.47</b>	<b>2.00</b>	<b>0.6520</b>	<b>0.489</b>	<b>0.69</b>
R.H. ROUND DIE 2"OD				13268						
GAGE - Taperlock Style		2B		23228						
GAGE - Taperlock Style		3B		23229						
GAGE - Ring-Go		2A		23620						
GAGE - Ring-Go		3A		23621						
GAGE - Ring-NoGo		2A		23622						
GAGE - Ring-NoGo		3A		23623						
<b>13/16"-24 NS</b>						<i>Recommended Hole Size based on 75% Thread = .7715"</i>				
<b>HAND TAP</b>	<b>3</b>	<b>3B</b>	<b>6</b>	<b>16627</b>	<b>16628</b>	<b>4.47</b>	<b>2.00</b>	<b>0.6520</b>	<b>0.489</b>	<b>0.69</b>
R.H. ROUND DIE 2"OD				13270						
<b>7/8"-6 ACME</b>						<i>Recommended Hole Size based on 75% Thread = .7083"</i>				
<b>HAND TAP</b>		<b>2G</b>	<b>4</b>	<b>16631</b>		<b>4.69</b>	<b>2.22</b>	<b>0.6970</b>	<b>0.523</b>	<b>0.75</b>
<b>L.H. HAND TAP</b>		<b>2G</b>	<b>4</b>	<b>16635</b>		<b>4.69</b>	<b>2.22</b>	<b>0.6970</b>	<b>0.523</b>	<b>0.75</b>
<b>TANDEM TAP</b>		<b>2G</b>	<b>4</b>	<b>16637</b>		<b>8.63</b>	<b>4.38</b>	<b>0.6970</b>	<b>0.523</b>	<b>0.75</b>
<b>L.H. TANDEM TAP</b>		<b>2G</b>	<b>4</b>	<b>16638</b>		<b>8.63</b>	<b>4.38</b>	<b>0.6970</b>	<b>0.523</b>	<b>0.75</b>
<b>7/8"-9 NC</b>						<i>Recommended Hole Size based on 75% Thread = .7667"</i>				
<b>REGULAR SPIRAL FLUTE TAP</b>	<b>4</b>	<b>3B</b>	<b>4</b>	<b>16656</b>	<b>16657</b>	<b>4.69</b>	<b>2.22</b>	<b>0.6970</b>	<b>0.523</b>	<b>0.75</b>
<b>L.H. HAND TAP</b>	<b>4</b>	<b>3B</b>	<b>4</b>	<b>16642</b>	<b>16643</b>	<b>4.69</b>	<b>2.22</b>	<b>0.6970</b>	<b>0.523</b>	<b>0.75</b>
<b>SPIRAL POINT TAP</b>	<b>4</b>	<b>3B</b>	<b>3</b>	<b>16645</b>		<b>4.69</b>	<b>2.22</b>	<b>0.6970</b>	<b>0.523</b>	<b>0.75</b>
<b>+.005 HAND TAP</b>	<b>11</b>	<b>PLATING</b>	<b>4</b>	<b>16652</b>	<b>16653</b>	<b>4.69</b>	<b>2.22</b>	<b>0.6970</b>	<b>0.523</b>	<b>0.75</b>
<b>8" EXTENSION HAND TAP</b>	<b>4</b>	<b>3B</b>	<b>4</b>	<b>17700</b>	<b>17701</b>	<b>8.00</b>	<b>2.22</b>	<b>0.6970</b>	<b>0.523</b>	<b>0.75</b>
<b>CARB-I-SERT TAP</b>	<b>4</b>	<b>3B</b>	<b>4</b>	<b>41558</b>	<b>41559</b>	<b>4.69</b>	<b>1.34</b>	<b>0.6970</b>	<b>0.523</b>	<b>0.75</b>
<b>TiN COAT x 8" TAP</b>	<b>4</b>	<b>3B</b>	<b>4</b>	<b>50030</b>		<b>8.00</b>	<b>2.22</b>	<b>0.6970</b>	<b>0.523</b>	<b>0.75</b>
R.H. ROUND DIE 2"OD				13272						
L.H. ROUND DIE 2"OD				13273						



SIZE/ DESCRIPTION	GH #	CLASS OF FIT	# FLUTES	Click on Item Number below for Price List		OVERALL LENGTH	THREAD LENGTH	SHANK DIAMETER	SQUARE DIAMETER	SQUARE LENGTH
				ITEM #						
				PLUG	BOTTOM					
<b>7/8"-9 NC</b>						<i>See Previous Page for Recommended Hole Size</i>				
GAGE - Taperlock Style		2B		23233						
GAGE - Taperlock Style		3B		23234						
GAGE - Ring-Go		2A		23626						
GAGE - Ring-Go		3A		23627						
GAGE - Ring-NoGo		2A		23628						
GAGE - Ring-NoGo		3A		23629						
<b>7/8"-10 NS</b>						<i>Recommended Hole Size based on 75% Thread = .7776"</i>				
<b>HAND TAP</b>	<b>4</b>	<b>3B</b>	<b>4</b>	<b>16661</b>	<b>16662</b>	<b>4.69</b>	<b>2.22</b>	<b>0.6970</b>	<b>0.523</b>	<b>0.75</b>
<b>7/8"-12 NS</b>						<i>Recommended Hole Size based on 75% Thread = .7942"</i>				
<b>HAND TAP</b>	<b>4</b>	<b>3B</b>	<b>4</b>	<b>16666</b>	<b>16667</b>	<b>4.69</b>	<b>2.22</b>	<b>0.6970</b>	<b>0.523</b>	<b>0.75</b>
R.H. ROUND DIE 2"OD				13274						
GAGE - Taperlock Style		2B		22438						
GAGE - Taperlock Style		3B		22439						
GAGE - Ring-Go		2A		22440						
GAGE - Ring-Go		3A		22441						
GAGE - Ring-NoGo		2A		22442						
GAGE - Ring-NoGo		3A		22443						
<b>7/8"-14 NF</b>						<i>Recommended Hole Size based on 75% Thread = .8056"</i>				
<b>L.H. HAND TAP</b>	<b>4</b>	<b>3B</b>	<b>4</b>	<b>16671</b>	<b>16672</b>	<b>4.69</b>	<b>2.22</b>	<b>0.6970</b>	<b>0.523</b>	<b>0.75</b>
<b>SPIRAL POINT TAP</b>	<b>4</b>	<b>3B</b>	<b>3</b>	<b>17656</b>		<b>4.69</b>	<b>2.22</b>	<b>0.6970</b>	<b>0.523</b>	<b>0.75</b>
<b>HAND TAP</b>	<b>5</b>		<b>4</b>	<b>17749</b>	<b>17750</b>	<b>4.69</b>	<b>2.22</b>	<b>0.6970</b>	<b>0.523</b>	<b>0.75</b>
<b>HAND TAP</b>	<b>6</b>	<b>2B</b>	<b>4</b>	<b>17686</b>	<b>17687</b>	<b>4.69</b>	<b>2.22</b>	<b>0.6970</b>	<b>0.523</b>	<b>0.75</b>
<b>+.005 HAND TAP</b>	<b>11</b>	<b>PLATING</b>	<b>4</b>	<b>16676</b>	<b>16677</b>	<b>4.69</b>	<b>2.22</b>	<b>0.6970</b>	<b>0.523</b>	<b>0.75</b>
<b>CARB-I-SERT TAP</b>	<b>4</b>	<b>3B</b>	<b>4</b>	<b>41561</b>	<b>41562</b>	<b>4.69</b>	<b>1.34</b>	<b>0.6970</b>	<b>0.523</b>	<b>0.75</b>
R.H. ROUND DIE 2"OD				13276						
L.H. ROUND DIE 2"OD				13277						
GAGE - Taperlock Style		2B		23238						
GAGE - Taperlock Style		3B		23239						
GAGE - Ring-Go		2A		23632						
GAGE - Ring-Go		3A		23633						
GAGE - Ring-NoGo		2A		23634						
GAGE - Ring-NoGo		3A		23635						
<b>7/8"-16 NS</b>						<i>Recommended Hole Size based on 75% Thread = .8144"</i>				
<b>HAND TAP</b>	<b>3</b>	<b>3B</b>	<b>4</b>	<b>16681</b>	<b>16682</b>	<b>4.69</b>	<b>2.22</b>	<b>0.6970</b>	<b>0.523</b>	<b>0.75</b>
R.H. ROUND DIE 2"OD				13278						
GAGE - Taperlock Style		2B		22450						
GAGE - Taperlock Style		3B		22451						
GAGE - Ring-Go		2A		22452						
GAGE - Ring-Go		3A		22453						
GAGE - Ring-NoGo		2A		22454						
GAGE - Ring-NoGo		3A		22455						
<b>7/8"-18 NS</b>						<i>Recommended Hole Size based on 75% Thread = .8214"</i>				
<b>HAND TAP</b>	<b>3</b>	<b>3B</b>	<b>4</b>	<b>16686</b>	<b>16687</b>	<b>4.69</b>	<b>2.22</b>	<b>0.6970</b>	<b>0.523</b>	<b>0.75</b>
R.H. ROUND DIE 2"OD				13280						

TAPS, DIES & GAGES

Click on Item Number below for Price List

SIZE/ DESCRIPTION	GH #	CLASS OF FIT	# FLUTES	ITEM #		OVERALL LENGTH	THREAD LENGTH	SHANK DIAMETER	SQUARE DIAMETER	SQUARE LENGTH
				PLUG	BOTTOM					
<b>7/8"-20 NEF</b>						<i>Recommended Hole Size based on 75% Thread = .8265"</i>				
HAND TAP	3	3B	6	16691	16692	4.69	2.22	0.6970	0.523	0.75
HAND TAP	5	2B	6	16696	16697	4.69	2.22	0.6970	0.523	0.75
R.H. ROUND DIE 2"OD				13282						
GAGE - Taperlock Style		2B		23243						
GAGE - Taperlock Style		3B		23244						
GAGE - Ring-Go		2A		23638						
GAGE - Ring-Go		3A		23639						
GAGE - Ring-NoGo		2A		23640						
GAGE - Ring-NoGo		3A		23641						
<b>7/8"-24 NS</b>						<i>Recommended Hole Size based on 75% Thread = .834"</i>				
HAND TAP	3	3B	6	16701	16702	4.69	2.22	0.6970	0.523	0.75
R.H. ROUND DIE 2"OD				13284						
<b>7/8"-27 NS</b>						<i>Recommended Hole Size based on 75% Thread = .839"</i>				
HAND TAP	3	3B	6	16706	16707	4.69	2.22	0.6970	0.523	0.75
<b>7/8"-32 NS</b>						<i>Recommended Hole Size based on 75% Thread = .8447"</i>				
HAND TAP	3	3B	6	16711	16712	4.69	2.22	0.6970	0.523	0.75
R.H. ROUND DIE 2"OD				13286						
GAGE - Taperlock Style		2B		22456						
GAGE - Taperlock Style		3B		22457						
GAGE - Ring-Go		2A		22458						
GAGE - Ring-Go		3A		22459						
GAGE - Ring-NoGo		2A		22460						
GAGE - Ring-NoGo		3A		22461						
<b>15/16"-12 NS</b>						<i>Recommended Hole Size based on 75% Thread = .8567"</i>				
HAND TAP	4	3B	4	16716	16717	4.91	2.22	0.7600	0.570	0.75
R.H. ROUND DIE 2"OD				13288						
GAGE - Taperlock Style		2B		22462						
GAGE - Taperlock Style		3B		22463						
GAGE - Ring-Go		2A		22464						
GAGE - Ring-Go		3A		22465						
GAGE - Ring-NoGo		2A		22466						
GAGE - Ring-NoGo		3A		22467						
<b>15/16"-14 NS</b>						<i>Recommended Hole Size based on 75% Thread = .8681"</i>				
HAND TAP	4	3B	4	16721	16722	4.91	2.22	0.7600	0.570	0.75
R.H. ROUND DIE 2"OD				13290						
<b>15/16"-16 NS</b>						<i>Recommended Hole Size based on 75% Thread = .8769"</i>				
HAND TAP	3	3B	6	16726	16727	4.91	2.22	0.7600	0.570	0.75
R.H. ROUND DIE 2"OD				13292						
<b>15/16"-18 NS</b>						<i>Recommended Hole Size based on 75% Thread = .8839"</i>				
HAND TAP	3	3B	6	16731	16732	4.91	2.22	0.7600	0.570	0.75
R.H. ROUND DIE 2"OD				13294						
<b>15/16"-20 NEF</b>						<i>Recommended Hole Size based on 75% Thread = .889"</i>				
HAND TAP	3	3B	6	16736	16737	4.91	2.22	0.7600	0.570	0.75
HAND TAP	5	2B	6	16741	16742	4.91	2.22	0.7600	0.570	0.75
R.H. ROUND DIE 2"OD				13296						



Click on Item Number  
below for Price List

SIZE/ DESCRIPTION	GH #	CLASS OF FIT	# FLUTES	ITEM #		OVERALL LENGTH	THREAD LENGTH	SHANK DIAMETER	SQUARE DIAMETER	SQUARE LENGTH
				PLUG	BOTTOM					
<b>15/16"-20 NEF</b>						<i>See Previous Page for Recommended Hole Size</i>				
GAGE - Taperlock Style		2B		23248						
GAGE - Taperlock Style		3B		23249						
GAGE - Ring-Go		2A		23644						
GAGE - Ring-Go		3A		23645						
GAGE - Ring-NoGo		2A		23646						
GAGE - Ring-NoGo		3A		23647						
<b>15/16"-32 NS</b>						<i>Recommended Hole Size based on 75% Thread = .9702"</i>				
<b>HAND TAP</b>	<b>3</b>	<b>3B</b>	<b>6</b>	<b>16756</b>	<b>16757</b>	<b>4.91</b>	<b>2.22</b>	<b>0.7600</b>	<b>0.570</b>	<b>0.75</b>
R.H. ROUND DIE 2"OD				13298						
GAGE - Taperlock Style		2B		22468						
GAGE - Taperlock Style		3B		22469						
GAGE - Ring-Go		2A		22470						
GAGE - Ring-Go		3A		22471						
GAGE - Ring-NoGo		2A		22472						
GAGE - Ring-NoGo		3A		22473						
<b>.969"-32</b>										
N-05 LOCKNUT HEX DIE				13702						
<b>1"-5 ACME</b>						<i>Recommended Hole Size = .800"</i>				
<b>HAND TAP</b>		<b>2G</b>	<b>4</b>	<b>16760</b>		<b>5.13</b>	<b>2.50</b>	<b>0.8000</b>	<b>0.600</b>	<b>0.81</b>
<b>L.H. HAND TAP</b>		<b>2G</b>	<b>4</b>	<b>16764</b>		<b>5.13</b>	<b>2.50</b>	<b>0.8000</b>	<b>0.600</b>	<b>0.81</b>
<b>TANDEM TAP</b>		<b>2G</b>	<b>4</b>	<b>16766</b>		<b>10.13</b>	<b>5.25</b>	<b>0.6970</b>	<b>0.523</b>	<b>0.75</b>
<b>L.H. TANDEM TAP</b>		<b>2G</b>	<b>4</b>	<b>16767</b>		<b>10.13</b>	<b>5.25</b>	<b>0.6970</b>	<b>0.523</b>	<b>0.75</b>
<b>1"-8 ACME</b>						<i>Recommended Hole Size = .875"</i>				
<b>HAND TAP</b>		<b>2G</b>	<b>4</b>	<b>16770</b>		<b>5.13</b>	<b>2.50</b>	<b>0.8000</b>	<b>0.600</b>	<b>0.81</b>
<b>1"-8 NC</b>						<i>Recommended Hole Size based on 75% Thread = .8781"</i>				
<b>REGULAR SPIRAL FLUTE TAP</b>	<b>4</b>	<b>3B</b>	<b>4</b>	<b>16789</b>	<b>16790</b>	<b>5.13</b>	<b>2.50</b>	<b>0.8000</b>	<b>0.600</b>	<b>0.81</b>
<b>FAST SPIRAL FLUTE TAP</b>	<b>4</b>	<b>3B</b>	<b>4</b>	<b>17791</b>	<b>17792</b>	<b>5.13</b>	<b>2.50</b>	<b>0.8000</b>	<b>0.600</b>	<b>0.81</b>
<b>L.H. HAND TAP</b>	<b>4</b>	<b>3B</b>	<b>4</b>	<b>16775</b>	<b>16776</b>	<b>5.13</b>	<b>2.50</b>	<b>0.8000</b>	<b>0.600</b>	<b>0.81</b>
<b>HAND TAP</b>	<b>6</b>	<b>2B</b>	<b>4</b>	<b>17918</b>	<b>17919</b>	<b>5.13</b>	<b>2.50</b>	<b>0.8000</b>	<b>0.600</b>	<b>0.81</b>
<b>SPIRAL POINT TAP</b>	<b>4</b>	<b>3B</b>	<b>3</b>	<b>16778</b>		<b>5.13</b>	<b>2.50</b>	<b>0.8000</b>	<b>0.600</b>	<b>0.81</b>
<b>+.005 HAND TAP</b>	<b>11</b>	<b>PLATING</b>	<b>4</b>	<b>16785</b>	<b>16786</b>	<b>5.13</b>	<b>2.50</b>	<b>0.8000</b>	<b>0.600</b>	<b>0.81</b>
<b>+.005 SPIRAL POINT TAP</b>	<b>11</b>	<b>PLATING</b>	<b>3</b>	<b>16783</b>		<b>5.13</b>	<b>2.50</b>	<b>0.8000</b>	<b>0.600</b>	<b>0.81</b>
<b>+.010 HAND TAP</b>	<b>21</b>		<b>4</b>	<b>17732</b>	<b>17733</b>	<b>5.13</b>	<b>2.50</b>	<b>0.8000</b>	<b>0.600</b>	<b>0.81</b>
<b>8" EXTENSION HAND TAP</b>	<b>4</b>	<b>3B</b>	<b>4</b>	<b>16794</b>	<b>16795</b>	<b>8.00</b>	<b>2.50</b>	<b>0.8000</b>	<b>0.600</b>	<b>0.81</b>
<b>10" EXTENSION HAND TAP</b>	<b>4</b>	<b>3B</b>	<b>4</b>	<b>16799</b>	<b>16800</b>	<b>10.00</b>	<b>2.50</b>	<b>0.8000</b>	<b>0.600</b>	<b>0.81</b>
<b>12" EXTENSION HAND TAP</b>	<b>4</b>	<b>3B</b>	<b>4</b>	<b>18109</b>	<b>18110</b>	<b>12.00</b>	<b>2.50</b>	<b>0.8000</b>	<b>0.600</b>	<b>0.81</b>
<b>CARB-I-SERT TAP</b>	<b>4</b>	<b>3B</b>	<b>4</b>	<b>41564</b>	<b>41565</b>	<b>5.13</b>	<b>1.50</b>	<b>0.8000</b>	<b>0.600</b>	<b>0.81</b>
<b>TiN COAT x 8" TAP</b>	<b>4</b>	<b>3B</b>	<b>4</b>	<b>50021</b>		<b>8.00</b>	<b>2.50</b>	<b>0.8000</b>	<b>0.600</b>	<b>0.81</b>
R.H. ROUND DIE 2"OD				13300						
L.H. ROUND DIE 2"OD				13301						
GAGE - Taperlock Style		2B		23253						
GAGE - Taperlock Style		3B		23254						
GAGE - Ring-Go		2A		23650						
GAGE - Ring-Go		3A		23651						
GAGE - Ring-NoGo		2A		23652						
GAGE - Ring-NoGo		3A		23653						

TAPS, DIES & GAGES

Click on Item Number below for Price List

SIZE/ DESCRIPTION	GH #	CLASS OF FIT	# FLUTES	ITEM #		OVERALL LENGTH	THREAD LENGTH	SHANK DIAMETER	SQUARE DIAMETER	SQUARE LENGTH
				PLUG	BOTTOM					
<b>1"-10 NS</b>						<i>Recommended Hole Size based on 75% Thread = .9026"</i>				
HAND TAP	4	3B	4	16809	16810	5.13	2.50	0.8000	0.600	0.81
<b>1"-11 55° WHITWORTH PIPE</b>						<i>Recommended Hole Size: BSPT = 1.1719" / BSPP = 1.1875"</i>				
BSPT TAPER - MODIFIED TAP			5	16812	16813	3.75	1.75	1.1250	0.843	0.81
BSPP PARALLEL - MODIFIED TAP			5	16815	16816	3.75	1.75	1.1250	0.843	0.81
BSPT TAPER - FULL FORM TAP			5	17937		3.75	1.75	1.1250	0.843	0.81
BSPP PARALLEL - FULL FORM TAP			5	17928		3.75	1.75	1.1250	0.843	0.81
GAGE BSPP-Mod. DBL END w/handle				27056						
GAGE BSPT-Mod. w/handle				27017						
<b>1"-11.5 PIPE TAP NPT NPT/F NPS</b>						<i>Recommended Hole Size NPT = 1.1406" / NPTF = 1.1563"</i>				
NPT/F LEFT HAND TAPER TAP			5	16818		3.75	1.75	1.1250	0.843	0.81
NPT/F 6" EXTENSION TAPER TAP			5	16821		6.00	1.75	1.1250	0.843	0.81
NPT/F 10" EXTENSION TAPER TAP			5	16824		10.00	1.75	1.1250	0.843	0.81
CARB-I-SERT TAP			6	41811		3.75	1.44	1.1250	0.843	0.81
NPT/F COST CUTTER DRILL/TAP			4	29046		5.38	1.75	1.1250	0.843	0.81
NPT R.H. ROUND DIE 2-1/2"OD				13302						
NPS R.H. ROUND DIE 2-1/2"OD				13304						
GAGE L1 NPT PLG w/handle				24386						
GAGE L1 NPT RING				24384						
GAGE L1 NPTF PLG w/handle				24466						
GAGE L3 NPTF PLG w/handle				24468						
GAGE NPTF 6 step Plain Plug w/handle				24548						
GAGE L1 NPTF RING				24510						
GAGE L2 NPTF RING				24512						
GAGE NPTF 6 step Plain Ring				24582						
<b>1"-12 NF</b>						<i>Recommended Hole Size based on 75% Thread = .9192"</i>				
L.H. HAND TAP	4	3B	4	16829	16830	5.13	2.50	0.8000	0.600	0.81
HAND TAP	6	2B	4	16834	16835	5.13	2.50	0.8000	0.600	0.81
+.005 HAND TAP	11	PLATING	4	16839	16840	5.13	2.50	0.8000	0.600	0.81
CARB-I-SERT TAP	4	3B	4	41567	41568	5.13	1.50	0.8000	0.600	0.81
R.H. ROUND DIE 2"OD				13306						
L.H. ROUND DIE 2"OD				13307						
GAGE - Taperlock Style		2B		23258						
GAGE - Taperlock Style		3B		23259						
GAGE - Ring-Go		2A		23656						
GAGE - Ring-Go		3A		23657						
GAGE - Ring-NoGo		2A		23658						
GAGE - Ring-NoGo		3A		23659						



Click on Item Number below for Price List

SIZE/ DESCRIPTION	GH #	CLASS OF FIT	# FLUTES	ITEM #		OVERALL LENGTH	THREAD LENGTH	SHANK DIAMETER	SQUARE DIAMETER	SQUARE LENGTH
				PLUG	BOTTOM					
<b>1"-14 NS</b>						<i>Recommended Hole Size based on 75% Thread = .9306"</i>				
L.H. HAND TAP	4	3B	4	16844	16845	5.13	2.50	0.8000	0.600	0.81
SPIRAL POINT TAP	4	3B	3	17906		5.13	2.50	0.8000	0.600	0.81
HAND TAP	6	2B	4	16849	16850	5.13	2.50	0.8000	0.600	0.81
+.005 HAND TAP	11	PLATING	4	16854	16855	5.13	2.50	0.8000	0.600	0.81
R.H. ROUND DIE 2"OD				13308						
L.H. ROUND DIE 2"OD				13309						
GAGE - Taperlock Style		2B		23263						
GAGE - Taperlock Style		3B		23264						
GAGE - Ring-Go		2A		23662						
GAGE - Ring-Go		3A		23663						
GAGE - Ring-NoGo		2A		23664						
GAGE - Ring-NoGo		3A		23665						
<b>1"-16 NS</b>						<i>Recommended Hole Size based on 75% Thread = .9394"</i>				
L.H. HAND TAP	3	3B	6	17695	17696	5.13	2.50	0.8000	0.600	0.81
HAND TAP	3	3B	6	16859	16860	5.13	2.50	0.8000	0.600	0.81
R.H. ROUND DIE 2"OD				13310						
GAGE - Taperlock Style		2B		22486						
GAGE - Taperlock Style		3B		22487						
GAGE - Ring-Go		2A		22488						
GAGE - Ring-Go		3A		22489						
GAGE - Ring-NoGo		2A		22490						
GAGE - Ring-NoGo		3A		22491						
<b>1"-18 NS</b>						<i>Recommended Hole Size based on 75% Thread = .9464"</i>				
HAND TAP	3	3B	6	16864	16865	5.13	2.50	0.8000	0.600	0.81
R.H. ROUND DIE 2"OD				13312						
<b>1"-20 NEF</b>						<i>Recommended Hole Size based on 75% Thread = .9515"</i>				
L.H. HAND TAP	3	3B	6	17580	17581	5.13	2.50	0.8000	0.600	0.81
HAND TAP	3	3B	6	16869	16870	5.13	2.50	0.8000	0.600	0.81
HAND TAP	5	2B	6	16874	16875	5.13	2.50	0.8000	0.600	0.81
R.H. ROUND DIE 2"OD				13314						
GAGE - Taperlock Style		2B		23268						
GAGE - Taperlock Style		3B		23269						
GAGE - Ring-Go		2A		23668						
GAGE - Ring-Go		3A		23669						
GAGE - Ring-NoGo		2A		23670						
GAGE - Ring-NoGo		3A		23671						
<b>1"-24 NS</b>						<i>Recommended Hole Size based on 75% Thread = .959"</i>				
HAND TAP	3	3B	6	16879	16880	5.13	2.50	0.8000	0.600	0.81
R.H. ROUND DIE 2"OD				13316						
<b>1"-27 NS</b>						<i>Recommended Hole Size based on 75% Thread = .964"</i>				
HAND TAP	3	3B	6	16884	16885	5.13	2.50	0.8000	0.600	0.81
R.H. ROUND DIE 2"OD				13318						
<b>1"-32 NS</b>						<i>Recommended Hole Size based on 75% Thread = .9697"</i>				
HAND TAP	3	3B	6	16889	16890	5.13	2.50	0.8000	0.600	0.81
R.H. ROUND DIE 2"OD				13320						
GAGE - Taperlock Style		2B		22492						



TAPS, DIES & GAGES

Click on Item Number below for Price List

SIZE/ DESCRIPTION	GH #	CLASS OF FIT	# FLUTES	ITEM #		OVERALL LENGTH	THREAD LENGTH	SHANK DIAMETER	SQUARE DIAMETER	SQUARE LENGTH
				PLUG	BOTTOM					
<b>1"-32 NS</b>				<i>See Previous Page for Recommended Hole Size</i>						
GAGE - Taperlock Style		3B		22493						
GAGE - Ring-Go		2A		22494						
GAGE - Ring-Go		3A		22495						
GAGE - Ring-NoGo		2A		22496						
GAGE - Ring-NoGo		3A		22497						
<b>1 1/16"-12 NS</b>				<i>Recommended Hole Size based on 75% Thread = .9817"</i>						
<b>HAND TAP</b>	<b>4</b>		<b>4</b>	<b>17714</b>	<b>17715</b>	<b>5.13</b>	<b>2.50</b>	<b>0.8960</b>	<b>0.672</b>	<b>0.88</b>
<b>HAND TAP</b>	<b>5</b>	<b>3B</b>	<b>4</b>	<b>16893</b>	<b>16894</b>	<b>5.13</b>	<b>2.50</b>	<b>0.8960</b>	<b>0.672</b>	<b>0.88</b>
<b>HAND TAP</b>	<b>7</b>	<b>2B</b>	<b>4</b>	<b>16897</b>	<b>16898</b>	<b>5.13</b>	<b>2.50</b>	<b>0.8960</b>	<b>0.672</b>	<b>0.88</b>
<b>TiN COAT/HAND TAP</b>	<b>4</b>		<b>4</b>		<b>50031</b>	<b>5.13</b>	<b>2.50</b>	<b>0.8960</b>	<b>0.672</b>	<b>0.88</b>
R.H. ROUND DIE 2"OD				13322						
GAGE - Taperlock Style		2B		24982						
GAGE - Taperlock Style		3B		24983						
GAGE - Ring-Go		2A		22498						
GAGE - Ring-Go		3A		22499						
GAGE - Ring-NoGo		2A		22500						
GAGE - Ring-NoGo		3A		22501						
<b>1 1/16"-14 NS</b>				<i>Recommended Hole Size based on 75% Thread = .9931"</i>						
<b>HAND TAP</b>	<b>5</b>	<b>3B</b>	<b>6</b>	<b>16901</b>	<b>16902</b>	<b>4.00</b>	<b>1.50</b>	<b>0.8960</b>	<b>0.672</b>	<b>0.88</b>
<b>1 1/16"-16 NS</b>				<i>Recommended Hole Size based on 75% Thread = 1.002"</i>						
<b>HAND TAP</b>	<b>4</b>	<b>3B</b>	<b>6</b>	<b>16905</b>	<b>16906</b>	<b>4.00</b>	<b>1.50</b>	<b>0.8960</b>	<b>0.672</b>	<b>0.88</b>
<b>HAND TAP</b>	<b>6</b>	<b>2B</b>	<b>6</b>	<b>16909</b>	<b>16910</b>	<b>4.00</b>	<b>1.50</b>	<b>0.8960</b>	<b>0.672</b>	<b>0.88</b>
R.H. ROUND DIE 2"OD				13326						
GAGE - Taperlock Style		2B		22502						
GAGE - Taperlock Style		3B		22503						
GAGE - Ring-Go		2A		22504						
GAGE - Ring-Go		3A		22505						
GAGE - Ring-NoGo		2A		22506						
GAGE - Ring-NoGo		3A		22507						
<b>1 1/16"-18 NEF</b>				<i>Recommended Hole Size based on 75% Thread = 1.008"</i>						
<b>HAND TAP</b>	<b>4</b>	<b>3B</b>	<b>6</b>	<b>16913</b>	<b>16914</b>	<b>4.00</b>	<b>1.50</b>	<b>0.8960</b>	<b>0.672</b>	<b>0.88</b>
<b>HAND TAP</b>	<b>6</b>	<b>2B</b>	<b>6</b>	<b>16917</b>	<b>16918</b>	<b>4.00</b>	<b>1.50</b>	<b>0.8960</b>	<b>0.672</b>	<b>0.88</b>
R.H. ROUND DIE 2"OD				13330						
GAGE - Taperlock Style		2B		23273						
GAGE - Taperlock Style		3B		23274						
GAGE - Ring-Go		2A		23674						
GAGE - Ring-Go		3A		23675						
GAGE - Ring-NoGo		2A		23676						
GAGE - Ring-NoGo		3A		23677						
<b>1 1/16"-20 NS</b>				<i>Recommended Hole Size based on 75% Thread = 1.014"</i>						
<b>HAND TAP</b>	<b>4</b>	<b>3B</b>	<b>6</b>	<b>16921</b>	<b>16922</b>	<b>4.00</b>	<b>1.50</b>	<b>0.8960</b>	<b>0.672</b>	<b>0.88</b>
R.H. ROUND DIE 2"OD				13332						
GAGE - Taperlock Style		2B		22508						
GAGE - Taperlock Style		3B		22509						
GAGE - Ring-Go		2A		22510						



SIZE/ DESCRIPTION	GH #	CLASS OF FIT	# FLUTES	ITEM #		OVERALL LENGTH	THREAD LENGTH	SHANK DIAMETER	SQUARE DIAMETER	SQUARE LENGTH
				PLUG	BOTTOM					
				Click on Item Number below for Price List						
<b>1 1/16"-20 NS</b>						<i>See Previous Page for Recommended Hole Size</i>				
GAGE - Ring-Go		3A		22511						
GAGE - Ring-NoGo		2A		22512						
GAGE - Ring-NoGo		3A		22513						
<b>1 1/16"-24 NS</b>						<i>Recommended Hole Size based on 75% Thread = 1.021"</i>				
HAND TAP	4	3B	6	16925	16926	4.00	1.50	0.8960	0.672	0.88
<b>1 1/8"-5 ACME</b>						<i>Recommended Hole Size = .925"</i>				
HAND TAP		2G	4	16929		5.44	2.56	0.8960	0.672	0.88
L.H. HAND TAP		2G	4	16933		5.44	2.56	0.8960	0.672	0.88
TANDEM TAP		2G	4	16935		10.75	5.25	0.8000	0.600	0.81
L.H. TANDEM TAP		2G	4	16936		10.75	5.25	0.8000	0.600	0.81
<b>1 1/8"-7 NC</b>						<i>Recommended Hole Size based on 75% Thread = .9857"</i>				
L.H. HAND TAP	4	3B	4	16939	16940	5.44	2.56	0.8960	0.672	0.88
R.H. ROUND DIE 2-1/2"OD				13334						
L.H. ROUND DIE 2-1/2"OD				13335						
GAGE - Taperlock Style		2B		23278						
GAGE - Taperlock Style		3B		23279						
GAGE - Ring-Go		2A		23680						
GAGE - Ring-Go		3A		23681						
GAGE - Ring-NoGo		2A		23682						
GAGE - Ring-NoGo		3A		23683						
<b>1 1/8"-8 NS</b>						<i>Recommended Hole Size based on 75% Thread = 1.003"</i>				
HAND TAP	5	3B	4	16943	16944	5.44	2.56	0.8960	0.672	0.88
TiN COAT/HAND TAP	5	3B	4		50022	5.44	2.56	0.8960	0.672	0.88
R.H. ROUND DIE 2-1/2"OD				13464						
GAGE - Taperlock Style		2B		22520						
GAGE - Taperlock Style		3B		22521						
GAGE - Ring-Go		2A		22522						
GAGE - Ring-Go		3A		22523						
GAGE - Ring-NoGo		2A		22524						
GAGE - Ring-NoGo		3A		22525						
<b>1 1/8"-10 NS</b>						<i>Recommended Hole Size based on 75% Thread = 1.027"</i>				
HAND TAP	5	3B	4	16947	16948	5.44	2.56	0.8960	0.672	0.88
<b>1 1/8"-12 NF</b>						<i>Recommended Hole Size based on 75% Thread = 1.044"</i>				
L.H. HAND TAP	4	3B	4	16951	16952	5.44	2.56	0.8960	0.672	0.88
HAND TAP	6	2B	4	16955	16956	5.44	2.56	0.8960	0.672	0.88
+.005 HAND TAP	12	PLATING	4	17776	17777	5.44	2.56	0.8960	0.672	0.88
R.H. ROUND DIE 2-1/2"OD				13336						
L.H. ROUND DIE 2-1/2"OD				13337						
GAGE - Taperlock Style		2B		23283						
GAGE - Taperlock Style		3B		23284						
GAGE - Ring-Go		2A		23686						
GAGE - Ring-Go		3A		23687						
GAGE - Ring-NoGo		2A		23688						
GAGE - Ring-NoGo		3A		23689						
<b>1 1/8"-14 NS</b>						<i>Recommended Hole Size based on 75% Thread = 1.055"</i>				
HAND TAP	5	3B	6	16959	16960	4.00	1.50	0.8960	0.672	0.88

TAPS, DIES & GAGES

Click on Item Number below for Price List

SIZE/ DESCRIPTION	GH #	CLASS OF FIT	# FLUTES	ITEM #		OVERALL LENGTH	THREAD LENGTH	SHANK DIAMETER	SQUARE DIAMETER	SQUARE LENGTH
				PLUG	BOTTOM					
<b>1 1/8"-16 NS</b>						<i>Recommended Hole Size based on 75% Thread = 1.064"</i>				
<b>HAND TAP</b>	<b>4</b>	<b>3B</b>	<b>6</b>	<b>16963</b>	<b>16964</b>	<b>4.00</b>	<b>1.50</b>	<b>0.8960</b>	<b>0.672</b>	<b>0.88</b>
R.H. ROUND DIE 2-1/2"OD				13340						
GAGE - Taperlock Style		2B		22532						
GAGE - Taperlock Style		3B		22533						
GAGE - Ring-Go		2A		22534						
GAGE - Ring-Go		3A		22535						
GAGE - Ring-NoGo		2A		22536						
GAGE - Ring-NoGo		3A		22537						
<b>1 1/8"-18 NEF</b>						<i>Recommended Hole Size based on 75% Thread = 1.071"</i>				
<b>HAND TAP</b>	<b>4</b>	<b>3B</b>	<b>6</b>	<b>16967</b>	<b>16968</b>	<b>4.00</b>	<b>1.50</b>	<b>0.8960</b>	<b>0.672</b>	<b>0.88</b>
<b>HAND TAP</b>	<b>6</b>	<b>2B</b>	<b>6</b>	<b>16971</b>	<b>16972</b>	<b>4.00</b>	<b>1.50</b>	<b>0.8960</b>	<b>0.672</b>	<b>0.88</b>
R.H. ROUND DIE 2-1/2"OD				13342						
GAGE - Taperlock Style		2B		23288						
GAGE - Taperlock Style		3B		23289						
GAGE - Ring-Go		2A		23692						
GAGE - Ring-Go		3A		23693						
GAGE - Ring-NoGo		2A		23694						
GAGE - Ring-NoGo		3A		23695						
<b>1 1/8"-20 NS</b>						<i>Recommended Hole Size based on 75% Thread = 1.076"</i>				
<b>HAND TAP</b>	<b>4</b>	<b>3B</b>	<b>6</b>	<b>16975</b>	<b>16976</b>	<b>4.00</b>	<b>1.50</b>	<b>0.8960</b>	<b>0.672</b>	<b>0.88</b>
R.H. ROUND DIE 2-1/2"OD				13344						
GAGE - Taperlock Style		2B		22538						
GAGE - Taperlock Style		3B		22539						
GAGE - Ring-Go		2A		22540						
GAGE - Ring-Go		3A		22541						
GAGE - Ring-NoGo		2A		22542						
GAGE - Ring-NoGo		3A		22543						
<b>1 1/8"-24 NS</b>						<i>Recommended Hole Size based on 75% Thread = 1.084"</i>				
<b>HAND TAP</b>	<b>4</b>	<b>3B</b>	<b>6</b>	<b>16979</b>	<b>16980</b>	<b>4.00</b>	<b>1.50</b>	<b>0.8960</b>	<b>0.672</b>	<b>0.88</b>
<b>1 1/8"-28 NS</b>						<i>Recommended Hole Size based on 75% Thread = 1.0903"</i>				
<b>HAND TAP</b>	<b>4</b>	<b>3B</b>	<b>6</b>	<b>18114</b>	<b>18115</b>	<b>4.00</b>	<b>1.50</b>	<b>0.8960</b>	<b>0.672</b>	<b>0.88</b>
GAGE - Taperlock Style		2B		22544						
GAGE - Taperlock Style		3B		22545						
GAGE - Ring-Go		2A		22546						
GAGE - Ring-Go		3A		22547						
GAGE - Ring-NoGo		2A		22548						
GAGE - Ring-NoGo		3A		22549						
<b>1 1/8"-32 NS</b>						<i>Recommended Hole Size based on 75% Thread = 1.095"</i>				
<b>HAND TAP</b>	<b>4</b>	<b>3B</b>	<b>8</b>	<b>16987</b>	<b>16988</b>	<b>4.00</b>	<b>1.50</b>	<b>0.8960</b>	<b>0.672</b>	<b>0.88</b>
<b>1.173"-18</b>										
N-06 LOCKNUT HEX DIE				13703						
<b>1 3/16"-12 NS</b>						<i>Recommended Hole Size based on 75% Thread = 1.106"</i>				
<b>HAND TAP</b>	<b>5</b>	<b>3B</b>	<b>6</b>	<b>16991</b>	<b>16992</b>	<b>5.44</b>	<b>2.56</b>	<b>1.0210</b>	<b>0.766</b>	<b>1.00</b>
R.H. ROUND DIE 2-1/2"OD				13346						
GAGE - Taperlock Style		2B		24987						



Click on Item Number below for Price List

SIZE/ DESCRIPTION	GH #	CLASS OF FIT	# FLUTES	ITEM #		OVERALL LENGTH	THREAD LENGTH	SHANK DIAMETER	SQUARE DIAMETER	SQUARE LENGTH
				PLUG	BOTTOM					
<b>1 3/16"-12 NS</b>				<i>See Previous Page for Recommended Hole Size</i>						
GAGE - Taperlock Style		3B		24988						
GAGE - Ring-Go		2A		22550						
GAGE - Ring-Go		3A		22551						
GAGE - Ring-NoGo		2A		22552						
GAGE - Ring-NoGo		3A		22553						
<b>1 3/16"-14 NS</b>				<i>Recommended Hole Size based on 75% Thread = 1.118"</i>						
<b>HAND TAP</b>	<b>5</b>	<b>3B</b>	<b>6</b>	<b>16995</b>	<b>16996</b>	<b>4.00</b>	<b>1.50</b>	<b>1.0210</b>	<b>0.766</b>	<b>1.00</b>
<b>1 3/16"-16 NS</b>				<i>Recommended Hole Size based on 75% Thread = 1.127"</i>						
<b>HAND TAP</b>	<b>4</b>	<b>3B</b>	<b>6</b>	<b>16999</b>	<b>17000</b>	<b>4.00</b>	<b>1.50</b>	<b>1.0210</b>	<b>0.766</b>	<b>1.00</b>
<b>HAND TAP</b>	<b>6</b>	<b>2B</b>	<b>6</b>	<b>17003</b>	<b>17004</b>	<b>4.00</b>	<b>1.50</b>	<b>1.0210</b>	<b>0.766</b>	<b>1.00</b>
GAGE - Taperlock Style		2B		22554						
GAGE - Taperlock Style		3B		22555						
GAGE - Ring-Go		2A		22556						
GAGE - Ring-Go		3A		22557						
GAGE - Ring-NoGo		2A		22558						
GAGE - Ring-NoGo		3A		22559						
<b>1 3/16"-18 NEF</b>				<i>Recommended Hole Size based on 75% Thread = 1.134"</i>						
<b>HAND TAP</b>	<b>4</b>	<b>3B</b>	<b>6</b>	<b>17007</b>	<b>17008</b>	<b>4.00</b>	<b>1.50</b>	<b>1.0210</b>	<b>0.766</b>	<b>1.00</b>
<b>HAND TAP</b>	<b>6</b>	<b>2B</b>	<b>6</b>	<b>17011</b>	<b>17012</b>	<b>4.00</b>	<b>1.50</b>	<b>1.0210</b>	<b>0.766</b>	<b>1.00</b>
R.H. ROUND DIE 2-1/2"OD				13350						
GAGE - Taperlock Style		2B		23293						
GAGE - Taperlock Style		3B		23294						
GAGE - Ring-Go		2A		23698						
GAGE - Ring-Go		3A		23699						
GAGE - Ring-NoGo		2A		23700						
GAGE - Ring-NoGo		3A		23701						
<b>1 3/16"-20 NS</b>				<i>Recommended Hole Size based on 75% Thread = 1.139"</i>						
<b>HAND TAP</b>	<b>4</b>	<b>3B</b>	<b>6</b>	<b>17015</b>	<b>17016</b>	<b>4.00</b>	<b>1.50</b>	<b>1.0210</b>	<b>0.766</b>	<b>1.00</b>
GAGE - Taperlock Style		2B		22560						
GAGE - Taperlock Style		3B		22561						
GAGE - Ring-Go		2A		22562						
GAGE - Ring-Go		3A		22563						
GAGE - Ring-NoGo		2A		22564						
GAGE - Ring-NoGo		3A		22565						
<b>1 1/4"-5 ACME</b>				<i>Recommended Hole Size = 1.050"</i>						
<b>HAND TAP</b>		<b>2G</b>	<b>4</b>	<b>17019</b>		<b>5.75</b>	<b>2.56</b>	<b>1.0210</b>	<b>0.766</b>	<b>1.00</b>
<b>L.H. HAND TAP</b>		<b>2G</b>	<b>4</b>	<b>17023</b>		<b>5.75</b>	<b>2.56</b>	<b>1.0210</b>	<b>0.766</b>	<b>1.00</b>
<b>TANDEM TAP</b>		<b>2G</b>	<b>4</b>	<b>17025</b>		<b>11.13</b>	<b>5.25</b>	<b>0.8960</b>	<b>0.672</b>	<b>0.88</b>
<b>L.H. TANDEM TAP</b>		<b>2G</b>	<b>4</b>	<b>17026</b>		<b>11.13</b>	<b>5.25</b>	<b>0.8960</b>	<b>0.672</b>	<b>0.88</b>
<b>1 1/4"-7 NC</b>				<i>Recommended Hole Size based on 75% Thread = 1.110"</i>						
<b>L.H. HAND TAP</b>	<b>4</b>	<b>3B</b>	<b>4</b>	<b>17029</b>	<b>17030</b>	<b>5.75</b>	<b>2.56</b>	<b>1.0210</b>	<b>0.766</b>	<b>1.00</b>
<b>SPIRAL POINT TAP</b>	<b>4</b>	<b>3B</b>	<b>3</b>	<b>17920</b>		<b>5.75</b>	<b>2.56</b>	<b>1.0210</b>	<b>0.766</b>	<b>1.00</b>
<b>HAND TAP</b>	<b>8</b>	<b>2B</b>	<b>4</b>	<b>17033</b>	<b>17034</b>	<b>5.75</b>	<b>2.56</b>	<b>1.0210</b>	<b>0.766</b>	<b>1.00</b>
<b>+.005 HAND TAP</b>	<b>12</b>	<b>PLATING</b>	<b>4</b>	<b>17753</b>	<b>17754</b>	<b>5.75</b>	<b>2.56</b>	<b>1.0210</b>	<b>0.766</b>	<b>1.00</b>
<b>10" EXTENSION TAP</b>	<b>4</b>	<b>3B</b>	<b>4</b>	<b>17037</b>	<b>17038</b>	<b>10.00</b>	<b>2.56</b>	<b>1.0210</b>	<b>0.766</b>	<b>1.00</b>
<b>12" EXTENSION TAP</b>	<b>4</b>	<b>3B</b>	<b>4</b>	<b>17041</b>	<b>17042</b>	<b>12.00</b>	<b>2.56</b>	<b>1.0210</b>	<b>0.766</b>	<b>1.00</b>

TAPS, DIES & GAGES

Click on Item Number below for Price List

SIZE/ DESCRIPTION	GH #	CLASS OF FIT	# FLUTES	ITEM #		OVERALL LENGTH	THREAD LENGTH	SHANK DIAMETER	SQUARE DIAMETER	SQUARE LENGTH
				PLUG	BOTTOM					
<b>1 1/4"-7 NC</b>						<i>See Previous Page for Recommended Hole Size</i>				
<b>CARB-I-SERT TAP</b>	4	3B	4	41570	41571	5.75	1.72	1.0210	0.766	1.00
R.H. ROUND DIE 2-1/2"OD				13352						
L.H. ROUND DIE 2-1/2"OD				13353						
GAGE - Taperlock Style		2B		23298						
GAGE - Taperlock Style		3B		23299						
GAGE - Ring-Go		2A		23704						
GAGE - Ring-Go		3A		23705						
GAGE - Ring-NoGo		2A		23706						
GAGE - Ring-NoGo		3A		23707						
<b>1 1/4"-8 NS</b>						<i>Recommended Hole Size based on 75% Thread = 1.128"</i>				
<b>HAND TAP</b>	5	3B	4	17045	17046	5.75	2.56	1.0210	0.766	1.00
<b>10" EXTENSION TAP</b>	5	3B	4	17049	17050	10.00	2.56	1.0210	0.766	1.00
<b>12" EXTENSION TAP</b>	5	3B	4	17053	17054	12.00	2.56	1.0210	0.766	1.00
R.H. ROUND DIE 2-1/2"OD				13466						
GAGE - Taperlock Style		2B		22572						
GAGE - Taperlock Style		3B		22573						
GAGE - Ring-Go		2A		22574						
GAGE - Ring-Go		3A		22575						
GAGE - Ring-NoGo		2A		22576						
GAGE - Ring-NoGo		3A		22577						
<b>1 1/4"-10 NS</b>						<i>Recommended Hole Size based on 75% Thread = 1.152"</i>				
<b>HAND TAP</b>	5	3B	4	17057	17058	5.75	2.56	1.0210	0.766	1.00
<b>1 1/4"-11 55° WHITWORTH PIPE</b>						<i>Recommended Hole Size: BSPT = 1.500" / BSPP = 1.5469"</i>				
<b>BSPT TAPER - MODIFIED TAP</b>			5	17060	17061	4.00	1.75	1.3125	0.984	0.94
<b>BSPP PARALLEL - MODIFIED TAP</b>			5	17063	17064	4.00	1.75	1.3125	0.984	0.94
<b>BSPT TAPER - FULL FORM TAP</b>			5	17938		4.00	1.75	1.3125	0.984	0.94
<b>BSPP PARALLEL - FULL FORM TAP</b>			5	17929		4.00	1.75	1.3125	0.984	0.94
GAGE BSPP-Mod. DBL END w/handle				27059						
GAGE BSPT-Mod. w/handle				27020						
<b>1 1/4"-11.5 PIPE TAP NPS NPSF NPT/F</b>						<i>Recommended Hole Size: NPT = 1.4844" / NPTF = 1.500" / NPS = 1.500" / NPSM = 1.5469" / NPSF = 1.5050"</i>				
<b>NPT/F LEFT HAND TAPER TAP</b>			5	17066		4.00	1.75	1.3125	0.984	0.94
<b>NPS STRAIGHT TAP</b>			5	17069		4.00	1.75	1.3125	0.984	0.94
<b>NPSF STRAIGHT TAP</b>			5	17072		4.00	1.75	1.3125	0.984	0.94
GAGE L1 NPT PLG w/handle				24389						
GAGE L1 NPT RING				24387						
GAGE L1 NPTF PLG w/handle				24474						
GAGE L3 NPTF PLG w/handle				24476						
GAGE NPTF 6 step Plain Plug w/handle				24552						
GAGE L1 NPTF RING				24514						
GAGE L2 NPTF RING				24516						
GAGE NPTF 6 step Plain Ring				24586						



Click on Item Number  
below for Price List

SIZE/ DESCRIPTION	GH #	CLASS OF FIT	# FLUTES	ITEM #		OVERALL LENGTH	THREAD LENGTH	SHANK DIAMETER	SQUARE DIAMETER	SQUARE LENGTH
				PLUG	BOTTOM					
<b>1 1/4"-12 NF</b>						<i>Recommended Hole Size based on 75% Thread = 1.169"</i>				
L.H. HAND TAP	4	3B	6	17076	17077	5.75	2.56	1.0210	0.766	1.00
HAND TAP	6	2B	6	17080	17081	5.75	2.56	1.0210	0.766	1.00
R.H. ROUND DIE 2-1/2"OD				13354						
L.H. ROUND DIE 2-1/2"OD				13355						
GAGE - Taperlock Style		2B		23303						
GAGE - Taperlock Style		3B		23304						
GAGE - Ring-Go		2A		23710						
GAGE - Ring-Go		3A		23711						
GAGE - Ring-NoGo		2A		23712						
GAGE - Ring-NoGo		3A		23713						
<b>1 1/4"-14 NS</b>						<i>Recommended Hole Size based on 75% Thread = 1.180"</i>				
HAND TAP	5	3B	6	17084	17085	4.00	1.50	1.0210	0.766	1.00
<b>1 1/4"-16 NS</b>						<i>Recommended Hole Size based on 75% Thread = 1.189"</i>				
HAND TAP	4	3B	6	17088	17089	4.00	1.50	1.0210	0.766	1.00
R.H. ROUND DIE 2-1/2"OD				13356						
GAGE - Taperlock Style		2B		22584						
GAGE - Taperlock Style		3B		22585						
GAGE - Ring-Go		2A		22586						
GAGE - Ring-Go		3A		22587						
GAGE - Ring-NoGo		2A		22588						
GAGE - Ring-NoGo		3A		22589						
<b>1 1/4"-18 NEF</b>						<i>Recommended Hole Size based on 75% Thread = 1.196"</i>				
HAND TAP	4	3B	6	17092	17093	4.00	1.50	1.0210	0.766	1.00
HAND TAP	6	2B	6	17096	17097	4.00	1.50	1.0210	0.766	1.00
R.H. ROUND DIE 2-1/2"OD				13358						
GAGE - Taperlock Style		2B		23308						
GAGE - Taperlock Style		3B		23309						
GAGE - Ring-Go		2A		23716						
GAGE - Ring-Go		3A		23717						
GAGE - Ring-NoGo		2A		23718						
GAGE - Ring-NoGo		3A		23719						
<b>1 1/4"-20 NS</b>						<i>Recommended Hole Size based on 75% Thread = 1.201"</i>				
HAND TAP	4	3B	6	17100	17101	4.00	1.50	1.0210	0.766	1.00
R.H. ROUND DIE 2-1/2"OD				13360						
GAGE - Taperlock Style		2B		22590						
GAGE - Taperlock Style		3B		22591						
GAGE - Ring-Go		2A		22592						
GAGE - Ring-Go		3A		22593						
GAGE - Ring-NoGo		2A		22594						
GAGE - Ring-NoGo		3A		22595						
<b>1 1/4"-24 NS</b>						<i>Recommended Hole Size based on 75% Thread = 1.209"</i>				
HAND TAP	4	3B	8	17104	17105	4.00	1.50	1.0210	0.766	1.00
R.H. ROUND DIE 2-1/2"OD				13362						
<b>1 1/4"-32 NS</b>						<i>Recommended Hole Size based on 75% Thread = 1.219"</i>				
HAND TAP	4	3B	10	17108	17109	4.00	1.50	1.0210	0.766	1.00

TAPS, DIES & GAGES

Click on Item Number below for Price List

SIZE/ DESCRIPTION	GH #	CLASS OF FIT	# FLUTES	ITEM #		OVERALL LENGTH	THREAD LENGTH	SHANK DIAMETER	SQUARE DIAMETER	SQUARE LENGTH
				PLUG	BOTTOM					
<b>1 5/16"-12 NS</b>						<i>Recommended Hole Size based on 75% Thread = 1.232"</i>				
HAND TAP	5	3B	6	17112	17113	5.75	2.56	1.1080	0.831	1.06
HAND TAP	8	2B	6	17116	17117	5.75	2.56	1.1080	0.831	1.06
R.H. ROUND DIE 2-1/2"OD				13364						
GAGE - Taperlock Style		2B		24992						
GAGE - Taperlock Style		3B		24993						
GAGE - Ring-Go		2A		22596						
GAGE - Ring-Go		3A		22597						
GAGE - Ring-NoGo		2A		22598						
GAGE - Ring-NoGo		3A		22599						
<b>1 5/16"-16 NS</b>						<i>Recommended Hole Size based on 75% Thread = 1.252"</i>				
HAND TAP	4	3B	6	17124	17125	4.00	1.50	1.1080	0.831	1.00
HAND TAP	6	2B	6	17128	17129	4.00	1.50	1.1080	0.831	1.00
GAGE - Taperlock Style		2B		22600						
GAGE - Taperlock Style		3B		22601						
GAGE - Ring-Go		2A		22602						
GAGE - Ring-Go		3A		22603						
GAGE - Ring-NoGo		2A		22604						
GAGE - Ring-NoGo		3A		22605						
<b>1 5/16"-18 NEF</b>						<i>Recommended Hole Size based on 75% Thread = 1.259"</i>				
HAND TAP	4	3B	6	17132	17133	4.00	1.50	1.1080	0.831	1.00
HAND TAP	6	2B	6	17136	17137	4.00	1.50	1.1080	0.831	1.00
R.H. ROUND DIE 2-1/2"OD				13370						
GAGE - Taperlock Style		2B		23313						
GAGE - Taperlock Style		3B		23314						
GAGE - Ring-Go		2A		23722						
GAGE - Ring-Go		3A		23723						
GAGE - Ring-NoGo		2A		23724						
GAGE - Ring-NoGo		3A		23725						
<b>1 5/16"-20 NS</b>						<i>Recommended Hole Size based on 75% Thread = 1.264"</i>				
HAND TAP	4	3B	6	17140	17141	4.00	1.50	1.1080	0.831	1.00
GAGE - Taperlock Style		2B		22606						
GAGE - Taperlock Style		3B		22607						
GAGE - Ring-Go		2A		22608						
GAGE - Ring-Go		3A		22609						
GAGE - Ring-NoGo		2A		22610						
GAGE - Ring-NoGo		3A		22611						
<b>1 3/8"-4 ACME</b>						<i>Recommended Hole = 1.1250"</i>				
HAND TAP		2G	4	17144		6.06	3.00	1.1080	0.831	1.06
L.H. HAND TAP		2G	4	17148		6.06	3.00	1.1080	0.831	1.06
TANDEM TAP		2G	4	17150		12.25	5.88	1.1080	0.831	1.25
<b>1 3/8"-6 NC</b>						<i>Recommended Hole Size based on 75% Thread = 1.212"</i>				
L.H. HAND TAP	4	3B	4	17154	17155	6.06	3.00	1.1080	0.831	1.06
R.H. ROUND DIE 2-1/2"OD				13372						
GAGE - Taperlock Style		2B		23318						
GAGE - Taperlock Style		3B		23319						





Click on Item Number below for Price List

SIZE/ DESCRIPTION	GH #	CLASS OF FIT	# FLUTES	ITEM #		OVERALL LENGTH	THREAD LENGTH	SHANK DIAMETER	SQUARE DIAMETER	SQUARE LENGTH
				PLUG	BOTTOM					
<b>1 3/8"-6 NC</b>						<i>See Previous Page for Recommended Hole Size</i>				
GAGE - Ring-Go		2A		23728						
GAGE - Ring-Go		3A		23729						
GAGE - Ring-NoGo		2A		23730						
GAGE - Ring-NoGo		3A		23731						
<b>1 3/8"-8 NS</b>						<i>Recommended Hole Size based on 75% Thread = 1.253"</i>				
<b>HAND TAP</b>	<b>5</b>	<b>3B</b>	<b>4</b>	<b>17158</b>	<b>17159</b>	<b>6.06</b>	<b>3.00</b>	<b>1.1080</b>	<b>0.831</b>	<b>1.06</b>
R.H. ROUND DIE 2-1/2"OD				13468						
GAGE - Taperlock Style		2B		22618						
GAGE - Taperlock Style		3B		22619						
GAGE - Ring-Go		2A		22620						
GAGE - Ring-Go		3A		22621						
GAGE - Ring-NoGo		2A		22622						
GAGE - Ring-NoGo		3A		22623						
<b>1 3/8"-12 NF</b>						<i>Recommended Hole Size based on 75% Thread = 1.294"</i>				
<b>L.H. HAND TAP</b>	<b>4</b>	<b>3B</b>	<b>6</b>	<b>17166</b>	<b>17167</b>	<b>6.06</b>	<b>3.00</b>	<b>1.1080</b>	<b>0.831</b>	<b>1.06</b>
<b>CARB-I-SERT TAP</b>	<b>4</b>	<b>3B</b>	<b>4</b>	<b>41573</b>	<b>41574</b>	<b>6.06</b>	<b>2.00</b>	<b>1.1080</b>	<b>0.831</b>	<b>1.06</b>
R.H. ROUND DIE 2-1/2"OD				13374						
L.H. ROUND DIE 2-1/2"OD				13375						
GAGE - Taperlock Style		2B		23323						
GAGE - Taperlock Style		3B		23324						
GAGE - Ring-Go		2A		23734						
GAGE - Ring-Go		3A		23735						
GAGE - Ring-NoGo		2A		23736						
GAGE - Ring-NoGo		3A		23737						
<b>1 3/8"-16 NS</b>						<i>Recommended Hole Size based on 75% Thread = 1.314"</i>				
<b>HAND TAP</b>	<b>4</b>	<b>3B</b>	<b>6</b>	<b>17170</b>	<b>17171</b>	<b>4.00</b>	<b>1.50</b>	<b>1.1080</b>	<b>0.831</b>	<b>1.00</b>
R.H. ROUND DIE 2-1/2"OD				13378						
GAGE - Taperlock Style		2B		22630						
GAGE - Taperlock Style		3B		22631						
GAGE - Ring-Go		2A		22632						
GAGE - Ring-Go		3A		22633						
GAGE - Ring-NoGo		2A		22634						
GAGE - Ring-NoGo		3A		22635						
<b>1 3/8"-18 NEF</b>						<i>Recommended Hole Size based on 75% Thread = 1.321"</i>				
<b>HAND TAP</b>	<b>4</b>	<b>3B</b>	<b>6</b>	<b>17174</b>	<b>17175</b>	<b>4.00</b>	<b>1.50</b>	<b>1.1080</b>	<b>0.831</b>	<b>1.00</b>
<b>HAND TAP</b>	<b>6</b>	<b>2B</b>	<b>6</b>	<b>17178</b>	<b>17179</b>	<b>4.00</b>	<b>1.50</b>	<b>1.1080</b>	<b>0.831</b>	<b>1.00</b>
R.H. ROUND DIE 2-1/2"OD				13380						
GAGE - Taperlock Style		2B		23328						
GAGE - Taperlock Style		3B		23329						
GAGE - Ring-Go		2A		23740						
GAGE - Ring-Go		3A		23741						
GAGE - Ring-NoGo		2A		23742						
GAGE - Ring-NoGo		3A		23743						
<b>1 3/8"-20 NS</b>						<i>Recommended Hole Size based on 75% Thread = 1.326"</i>				
<b>HAND TAP</b>	<b>4</b>	<b>3B</b>	<b>6</b>	<b>17182</b>	<b>17183</b>	<b>4.00</b>	<b>1.50</b>	<b>1.1080</b>	<b>0.831</b>	<b>1.00</b>
R.H. ROUND DIE 2-1/2"OD				13382						

TAPS, DIES & GAGES

Click on Item Number below for Price List

SIZE/ DESCRIPTION	GH #	CLASS OF FIT	# FLUTES	ITEM #		OVERALL LENGTH	THREAD LENGTH	SHANK DIAMETER	SQUARE DIAMETER	SQUARE LENGTH
				PLUG	BOTTOM					
<b>1 3/8"-20 NS</b>						<i>See Previous Page for Recommended Hole Size</i>				
GAGE - Taperlock Style		2B		22636						
GAGE - Taperlock Style		3B		22637						
GAGE - Ring-Go		2A		22638						
GAGE - Ring-Go		3A		22639						
GAGE - Ring-NoGo		2A		22640						
GAGE - Ring-NoGo		3A		22641						
<b>1 7/16"-18 NEF</b>						<i>Recommended Hole Size based on 75% Thread = 1.384"</i>				
HAND TAP	4	3B	6	17186	17187	4.00	1.50	1.2330	0.925	1.00
HAND TAP	6	2B	6	17190	17191	4.00	1.50	1.2330	0.925	1.00
GAGE - Taperlock Style		2B		23333						
GAGE - Taperlock Style		3B		23334						
GAGE - Ring-Go		2A		23746						
GAGE - Ring-Go		3A		23747						
GAGE - Ring-NoGo		2A		23748						
GAGE - Ring-NoGo		3A		23749						
<b>1 1/2"-4 ACME</b>						<i>Recommended Hole Size = 1.250"</i>				
HAND TAP		2G	4	17194		6.38	3.00	1.2330	0.925	1.13
L.H. HAND TAP		2G	4	17198		6.38	3.00	1.2330	0.925	1.13
TANDEM TAP		2G	4	17200		12.63	5.88	1.2330	0.925	1.25
L.H. TANDEM TAP		2G	4	17201		12.63	5.88	1.2330	0.925	1.25
<b>1 1/2"-6 NC</b>						<i>Recommended Hole Size Based on 75% Thread = 1.337"</i>				
L.H. HAND TAP	4	3B	4	17204	17205	6.38	3.00	1.2330	0.925	1.13
10" EXTENSION TAP	4	3B	4	17208	17209	10.00	3.00	1.2330	0.925	1.13
12" EXTENSION TAP	4	3B	4	17212	17213	12.00	3.00	1.2330	0.925	1.13
CARB-I-SERT TAP	4	3B	4	41576	41577	6.38	2.00	1.2330	0.925	1.13
R.H. ROUND DIE 2-1/2"OD				13392						
L.H. ROUND DIE 2-1/2"OD				13393						
GAGE - Taperlock Style		2B		23338						
GAGE - Taperlock Style		3B		23339						
GAGE - Ring-Go		2A		23752						
GAGE - Ring-Go		3A		23753						
GAGE - Ring-NoGo		2A		23754						
GAGE - Ring-NoGo		3A		23755						
<b>1 1/2"-8 NS</b>						<i>Recommended Hole Size based on 75% Thread = 1.378"</i>				
HAND TAP	5	3B	6	17216	17217	6.38	3.00	1.2330	0.925	1.13
10" EXTENSION TAP	5	3B	4	17220	17221	10.00	3.00	1.2330	0.925	1.13
12" EXTENSION TAP	5	3B	4	17224	17225	12.00	3.00	1.2330	0.925	1.13
R.H. ROUND DIE 2-1/2"OD				13470						
GAGE - Taperlock Style		2B		22648						
GAGE - Taperlock Style		3B		22649						
GAGE - Ring-Go		2A		22650						
GAGE - Ring-Go		3A		22651						
GAGE - Ring-NoGo		2A		22652						
GAGE - Ring-NoGo		3A		22653						



Click on Item Number below for Price List

SIZE/ DESCRIPTION	GH #	CLASS OF FIT	# FLUTES	ITEM #		OVERALL LENGTH	THREAD LENGTH	SHANK DIAMETER	SQUARE DIAMETER	SQUARE LENGTH
				PLUG	BOTTOM					
<b>1 1/2"-10 NS</b>						<i>Recommended Hole Size based on 75% Thread = 1.402"</i>				
HAND TAP	5	3B	6	17228	17229	6.38	3.00	1.2330	0.925	1.13
<b>1 1/2"-11 55° WHITWORTH PIPE</b>						<i>Recommended Hole Size: BSPT = 1.750" / BSPP = 1.7656"</i>				
BSPT TAPER - MODIFIED TAP			7	17231	17232	4.25	1.75	1.5000	1.125	1.00
BSPP PARALLEL - MODIFIED TAP			7	17234	17235	4.25	1.75	1.5000	1.125	1.00
BSPT TAPER - FULL FORM TAP			7	17939		4.25	1.75	1.5000	1.125	1.00
BSPP PARALLEL - FULL FORM TAP			7	17930		4.25	1.75	1.5000	1.125	1.00
GAGE BSPP DBL END w/ handle				27062						
GAGE BSPT w/handle				27023						
<b>1 1/2"-11.5 PIPE NPS NPT/F</b>						<i>Recommended Hole Size: NPT/NPTF = 1.7344" NPSC = 1.750" / NPSM = 1.7913"</i>				
NPT/F LEFT HAND TAPER TAP			7	17237		4.25	1.75	1.5000	1.125	1.00
NPS STRAIGHT TAP			7	17240		4.25	1.75	1.5000	1.125	1.00
GAGE L1 NPT PLG w/handle				24392						
GAGE L1 NPT RING				24390						
GAGE L1 NPTF PLG w/handle				24482						
GAGE L3 NPTF PLG w/handle				24484						
GAGE NPTF 6 step Plain Plug w/handle				24556						
GAGE L1 NPTF RING				24518						
GAGE L2 NPTF RING				24520						
GAGE NPTF 6 step Plain Ring				24590						
<b>1 1/2"-12 NF</b>						<i>Recommended Hole Size based on 75% Thread = 1.419"</i>				
L.H. HAND TAP	4	3B	6	17244	17245	6.38	3.00	1.2330	0.925	1.13
HAND TAP	6	2B	6	17248	17249	6.38	3.00	1.2330	0.925	1.13
R.H. ROUND DIE 2-1/2 "OD				13394						
L.H. ROUND DIE 2-1/2 "OD				13395						
GAGE - Taperlock Style		2B		23343						
GAGE - Taperlock Style		3B		23344						
GAGE - Ring-Go		2A		23758						
GAGE - Ring-Go		3A		23759						
GAGE - Ring-NoGo		2A		23760						
GAGE - Ring-NoGo		3A		23761						
<b>1 1/2"-16 NS</b>						<i>Recommended Hole Size based on 75% Thread = 1.439"</i>				
HAND TAP	4	3B	6	17252	17253	4.00	1.50	1.2330	0.925	1.00
R.H. ROUND DIE 2-1/2 "OD				13398						
<b>1 1/2"-16 NS</b>						<i>See Previous Page for Recommended Hole Size</i>				
GAGE - Taperlock Style		2B		22660						
GAGE - Taperlock Style		3B		22661						
GAGE - Ring-Go		2A		22662						
GAGE - Ring-Go		3A		22663						
GAGE - Ring-NoGo		2A		22664						
GAGE - Ring-NoGo		3A		22665						
<b>1 1/2"-18 NEF</b>						<i>Recommended Hole Size based on 75% Thread = 1.446"</i>				
HAND TAP	4	3B	6	17256	17257	4.00	1.50	1.2330	0.925	1.00



TAPS, DIES & GAGES

Click on Item Number below for Price List

SIZE/ DESCRIPTION	GH #	CLASS OF FIT	# FLUTES	ITEM #		OVERALL LENGTH	THREAD LENGTH	SHANK DIAMETER	SQUARE DIAMETER	SQUARE LENGTH
				PLUG	BOTTOM					
<b>1 1/2"-18 NEF</b>						<i>See Previous Page for Recommended Hole Size</i>				
<b>HAND TAP</b>	<b>6</b>	<b>2B</b>	<b>6</b>	<b>17260</b>	<b>17261</b>	<b>4.00</b>	<b>1.50</b>	<b>1.2330</b>	<b>0.925</b>	<b>1.00</b>
R.H. ROUND DIE 2-1/2 "OD				13400						
GAGE - Taperlock Style		2B		23348						
GAGE - Taperlock Style		3B		23349						
GAGE - Ring-Go		2A		23764						
GAGE - Ring-Go		3A		23765						
GAGE - Ring-NoGo		2A		23766						
GAGE - Ring-NoGo		3A		23767						
<b>1 1/2"-20 NS</b>						<i>Recommended Hole Size based on 75% Thread = 1.451"</i>				
<b>HAND TAP</b>	<b>4</b>	<b>3B</b>	<b>6</b>	<b>17264</b>	<b>17265</b>	<b>4.00</b>	<b>1.50</b>	<b>1.2330</b>	<b>0.925</b>	<b>1.00</b>
R.H. ROUND DIE 2-1/2 "OD				13402						
GAGE - Taperlock Style		2B		22666						
GAGE - Taperlock Style		3B		22667						
GAGE - Ring-Go		2A		22668						
GAGE - Ring-Go		3A		22669						
GAGE - Ring-NoGo		2A		22670						
GAGE - Ring-NoGo		3A		22671						
<b>1 1/2"-24 NS</b>						<i>Recommended Hole Size based on 75% Thread = 1.459"</i>				
<b>HAND TAP</b>	<b>4</b>	<b>3B</b>	<b>8</b>	<b>17268</b>	<b>17269</b>	<b>4.00</b>	<b>1.50</b>	<b>1.2330</b>	<b>0.925</b>	<b>1.00</b>
<b>1 9/16"-16 NS</b>						<i>Recommended Hole Size based on 75% Thread = 1.502"</i>				
<b>HAND TAP</b>	<b>5</b>	<b>3B</b>	<b>6</b>	<b>17272</b>	<b>17273</b>	<b>5.00</b>	<b>2.00</b>	<b>1.3050</b>	<b>0.979</b>	<b>1.13</b>
<b>1 9/16"-18 NEF</b>						<i>Recommended Hole Size based on 75% Thread = 1.509"</i>				
<b>HAND TAP</b>	<b>5</b>	<b>3B</b>	<b>6</b>	<b>17276</b>	<b>17277</b>	<b>5.00</b>	<b>2.00</b>	<b>1.3050</b>	<b>0.979</b>	<b>1.13</b>
R.H. ROUND DIE 3" OD				13408						
<b>1 5/8"-5.5 NS</b>						<i>Recommended Hole Size based on 75% Thread = 1.448"</i>				
<b>HAND TAP</b>	<b>7</b>	<b>3B</b>	<b>6</b>	<b>17280</b>	<b>17281</b>	<b>6.69</b>	<b>3.19</b>	<b>1.3050</b>	<b>0.979</b>	<b>1.13</b>
<b>1 5/8"-8 NS</b>						<i>Recommended Hole Size based on 75% Thread = 1.503"</i>				
<b>HAND TAP</b>	<b>6</b>	<b>3B</b>	<b>6</b>	<b>17284</b>	<b>17285</b>	<b>6.69</b>	<b>3.19</b>	<b>1.3050</b>	<b>0.979</b>	<b>1.13</b>
<b>1 5/8"-12 NS</b>						<i>Recommended Hole Size based on 75% Thread = 1.544"</i>				
<b>HAND TAP</b>	<b>4</b>	<b>3B</b>	<b>6</b>	<b>17908</b>	<b>17909</b>	<b>5.00</b>	<b>2.00</b>	<b>1.3050</b>	<b>0.979</b>	<b>1.13</b>
<b>HAND TAP</b>	<b>6</b>	<b>2B</b>	<b>6</b>	<b>17288</b>	<b>17289</b>	<b>5.00</b>	<b>2.00</b>	<b>1.3050</b>	<b>0.979</b>	<b>1.13</b>
R.H. ROUND DIE 3" OD				13412						
GAGE - Trilock Style		2B		22672						
GAGE - Trilock Style		3B		22673						
GAGE - Ring-Go		2A		22674						
GAGE - Ring-Go		3A		22675						
GAGE - Ring-NoGo		2A		22676						
GAGE - Ring-NoGo		3A		22677						
<b>1 5/8"-16 NS</b>						<i>Recommended Hole Size based on 75% Thread = 1.564"</i>				
<b>HAND TAP</b>	<b>5</b>	<b>3B</b>	<b>6</b>	<b>17292</b>	<b>17293</b>	<b>5.00</b>	<b>2.00</b>	<b>1.3050</b>	<b>0.979</b>	<b>1.13</b>
R.H. ROUND DIE 3" OD				13414						
<b>1 5/8"-18 NEF</b>						<i>Recommended Hole Size based on 75% Thread = 1.571"</i>				
<b>HAND TAP</b>	<b>5</b>	<b>3B</b>	<b>6</b>	<b>17296</b>	<b>17297</b>	<b>5.00</b>	<b>2.00</b>	<b>1.3050</b>	<b>0.979</b>	<b>1.13</b>
R.H. ROUND DIE 3" OD				13416						



Click on Item Number below for Price List

SIZE/ DESCRIPTION	GH #	CLASS OF FIT	# FLUTES	ITEM #		OVERALL LENGTH	THREAD LENGTH	SHANK DIAMETER	SQUARE DIAMETER	SQUARE LENGTH
				PLUG	BOTTOM					
<b>1 3/4"-5 NC</b>						<i>Recommended Hole Size based on 75% Thread = 1.555"</i>				
HAND TAP	7	3B	6	17300	17301	7.00	3.19	1.4300	1.072	1.25
R.H. ROUND DIE 3" OD				13420						
<b>1 3/4"-8 NS</b>						<i>Recommended Hole Size based on 75% Thread = 1.628"</i>				
HAND TAP	6	3B	6	17304	17305	7.00	3.19	1.4300	1.072	1.25
R.H. ROUND DIE 3" OD				13474						
<b>1 3/4"-10 NS</b>						<i>Recommended Hole Size based on 75% Thread = 1.652"</i>				
HAND TAP	6	3B	6	17308	17309	7.00	3.19	1.4300	1.072	1.25
<b>1 3/4"-12 NS</b>						<i>Recommended Hole Size based on 75% Thread = 1.669"</i>				
HAND TAP	6	3B	6	17312	17313	5.00	2.00	1.4300	1.072	1.25
HAND TAP	8	2B	6	17316	17317	5.00	2.00	1.4300	1.072	1.25
R.H. ROUND DIE 3" OD				13422						
GAGE - Trilock Style		2B		22678						
GAGE - Trilock Style		3B		22679						
GAGE - Ring-Go		2A		22680						
GAGE - Ring-Go		3A		22681						
GAGE - Ring-NoGo		2A		22682						
GAGE - Ring-NoGo		3A		22683						
<b>1 3/4"-16 NS</b>						<i>Recommended Hole Size based on 75% Thread = 1.689"</i>				
HAND TAP	5	3B	6	17320	17321	5.00	2.00	1.4300	1.072	1.25
HAND TAP	7	2B	6	17324	17325	5.00	2.00	1.4300	1.072	1.25
R.H. ROUND DIE 3" OD				13426						
<b>1 3/4"-18 NS</b>						<i>Recommended Hole Size based on 75% Thread = 1.696"</i>				
HAND TAP	5	3B	6	17328	17329	5.00	2.00	1.4300	1.072	1.25
R.H. ROUND DIE 3" OD				13428						
<b>1 7/8"-5 NS</b>						<i>Recommended Hole Size based on 75% Thread = 1.680"</i>				
HAND TAP	7	3B	6	17332	17333	7.31	3.56	1.5190	1.139	1.25
<b>1 7/8"-8 NS</b>						<i>Recommended Hole Size based on 75% Thread = 1.753"</i>				
HAND TAP	6	3B	6	17336	17337	7.31	3.56	1.5190	1.139	1.25
R.H. ROUND DIE 3" OD				13476						
<b>1 7/8"-12 NS</b>						<i>Recommended Hole Size based on 75% Thread = 1.794"</i>				
HAND TAP	6	3B	6	17340	17341	5.00	2.00	1.5190	1.139	1.25
HAND TAP	8	2B	6	17344	17345	5.00	2.00	1.5190	1.139	1.25
R.H. ROUND DIE 3" OD				13436						
GAGE - Trilock Style		2B		22684						
GAGE - Trilock Style		3B		22685						
GAGE - Ring-Go		2A		22686						
GAGE - Ring-Go		3A		22687						
GAGE - Ring-NoGo		2A		22688						
GAGE - Ring-NoGo		3A		22689						
<b>1 7/8"-16 NS</b>						<i>Recommended Hole Size based on 75% Thread = 1.814"</i>				
HAND TAP	5	3B	6	17348	17349	5.00	2.00	1.5190	1.139	1.25
R.H. ROUND DIE 3" OD			0	13438						
<b>2"-4.5 NC</b>						<i>Recommended Hole Size based on 75% Thread = 1.783"</i>				
HAND TAP	7	3B	6	17354	17355	7.63	3.56	1.6440	1.233	1.38
R.H. ROUND DIE 3" OD				13446						

TAPS, DIES & GAGES

Click on Item Number below for Price List

SIZE/ DESCRIPTION	GH #	CLASS OF FIT	# FLUTES	ITEM #		OVERALL LENGTH	THREAD LENGTH	SHANK DIAMETER	SQUARE DIAMETER	SQUARE LENGTH
				PLUG	BOTTOM					
<b>2"-8 NS</b>										
<i>Recommended Hole Size based on 75% Thread = 1.878"</i>										
HAND TAP	6	3B	6	17358	17359	7.63	3.56	1.6440	1.233	1.38
R.H. ROUND DIE 3" OD				13478						
<b>2"-11 55° WHITWORTH PIPE</b>										
<i>Recommended Hole Size: BSPT = 2.2188" / BSPP = 2.250"</i>										
BSPT TAPER - MODIFIED TAP			7	17361	17362	4.25	1.75	1.8750	1.406	1.13
BSPP PARALLEL - MODIFIED TAP			7	17364	17365	4.25	1.75	1.8750	1.406	1.13
BSPT TAPER - FULL FORM TAP			7	17940		4.25	1.75	1.8750	1.406	1.13
BSPP PARALLEL - FULL FORM TAP			7	17931		4.25	1.75	1.8750	1.406	1.13
<b>2"-11.5 NPS NPT</b>										
<i>Recommended Hole Size: NPSC = 2.2188" / NPSM = 2.2638"</i>										
NPS STRAIGHT TAP			7	17370		4.25	1.75	1.8750	1.406	1.13
GAGE L1 NPT PLG w/handle				24395						
GAGE L1 NPT RING				24393						
<b>2"-12 NS</b>										
<i>Recommended Hole Size based on 75% Thread = 1.919"</i>										
HAND TAP	6	3B	6	17374	17375	5.00	2.00	1.6440	1.233	1.38
HAND TAP	8	2B	6	17378	17379	5.00	2.00	1.6440	1.233	1.38
R.H. ROUND DIE 3"OD				13452						
GAGE - Trilock Style		2B		22690						
GAGE - Trilock Style		3B		22691						
GAGE - Ring-Go		2A		22692						
GAGE - Ring-Go		3A		22693						
GAGE - Ring-NoGo		2A		22694						
GAGE - Ring-NoGo		3A		22695						
<b>2"-16 NS</b>										
<i>Recommended Hole Size based on 75% Thread = 1.939"</i>										
HAND TAP	5	3B	6	17382	17383	5.00	2.00	1.6440	1.233	1.38
R.H. ROUND DIE 3"OD				13456						
<b>2"-20 NS</b>										
<i>Recommended Hole Size based on 75% Thread = 1.951"</i>										
HAND TAP	5	3B	8	17386	17387	5.00	2.00	1.6440	1.233	1.38
R.H. ROUND DIE 3"OD				13460						
<b>2 1/8"-8 NS</b>										
<i>Recommended Hole Size based on 75% Thread = 2.003"</i>										
HAND TAP	6	3B	6	17390	17391	8.00	3.56	1.7690	1.327	1.38
<b>2 1/8"-12 NS</b>										
<i>Recommended Hole Size based on 75% Thread = 2.044"</i>										
HAND TAP	6	3B	6	17394	17395	5.25	2.00	1.7690	1.327	1.38
<b>2 1/8"-16 NS</b>										
<i>Recommended Hole Size based on 75% Thread = 2.064"</i>										
HAND TAP	5	3B	6	17398	17399	5.25	2.00	1.7690	1.327	1.38
<b>2 1/4"-4.5 NC</b>										
<i>Recommended Hole Size based on 75% Thread = 2.033"</i>										
HAND TAP	7	3B	6	17402	17403	8.25	3.56	1.8940	1.420	1.44
<b>2 1/4"-8 NS</b>										
<i>Recommended Hole Size based on 75% Thread = 2.128"</i>										
HAND TAP	6	3B	6	17406	17407	8.25	3.56	1.8940	1.420	1.44
<b>2 1/4"-12 NS</b>										
<i>Recommended Hole Size based on 75% Thread = .2169"</i>										
HAND TAP	6	3B	6	17410	17411	5.25	2.00	1.8940	1.420	1.44
GAGE - Trilock Style		2B		22696						
GAGE - Trilock Style		3B		22697						
GAGE - Ring-Go		2A		22698						
GAGE - Ring-Go		3A		22699						



SIZE/ DESCRIPTION	GH #	CLASS OF FIT	# FLUTES	ITEM #		OVERALL LENGTH	THREAD LENGTH	SHANK DIAMETER	SQUARE DIAMETER	SQUARE LENGTH
				PLUG	BOTTOM					
				Click on Item Number below for Price List						
<b>2 1/4"-12 NS</b>						<i>See Previous Page for Recommended Hole Size</i>				
GAGE - Ring-NoGo		2A		22700						
GAGE - Ring-NoGo		3A		22701						
<b>2 1/4"-16 NS</b>						<i>Recommended Hole Size based on 75% Thread = 2.189"</i>				
HAND TAP	5	3B	6	17414	17415	5.25	2.00	1.8940	1.420	1.44
<b>2 3/8"-8 NS</b>						<i>Recommended Hole Size based on 75% Thread = 2.253"</i>				
HAND TAP	6	3B	6	17418	17419	8.50	4.00	2.0190	1.514	1.44
<b>2 3/8"-12 NS</b>						<i>Recommended Hole Size based on 75% Thread = 2.294"</i>				
HAND TAP	6	3B	6	17422	17423	5.25	2.00	2.0190	1.514	1.44
<b>2 3/8"-16 NS</b>						<i>Recommended Hole Size based on 75% Thread = 2.314"</i>				
HAND TAP	5	3B	6	17426	17427	5.25	2.00	2.0190	1.514	1.44
<b>2 1/2"-4 NC</b>						<i>Recommended Hole Size based on 75% Thread = 2.256"</i>				
HAND TAP	7	3B	6	17430	17431	8.75	4.00	2.1000	1.575	1.50
<b>2 1/2"-8 NS</b>						<i>Recommended Hole Size based on 75% Thread = 2.378"</i>				
HAND TAP	6	3B	6	17434	17435	8.75	4.00	2.1000	1.575	1.50
<b>2 1/2"-8 PIPE TAP NPT/F</b>						<i>Recommended Hole Size: NPT = 2.625" / NPTF = 2.6406"</i>				
NPT/F TAPER TAP			7	17437		5.50	2.56	2.2500	1.687	1.25
GAGE L1 NPT PLG w/handle				24398						
GAGE L1 NPT RING				24396						
<b>2 1/2"-12 NS</b>						<i>Recommended Hole Size based on 75% Thread = 2.419"</i>				
HAND TAP	6	3B	6	17444	17445	5.25	2.00	2.1000	1.575	1.50
GAGE - Trilock Style		2B		22702						
GAGE - Trilock Style		3B		22703						
GAGE - Ring-Go		2A		22704						
GAGE - Ring-Go		3A		22705						
GAGE - Ring-NoGo		2A		22706						
GAGE - Ring-NoGo		3A		22707						
<b>2 1/2"-16 NS</b>						<i>Recommended Hole Size based on 75% Thread = 2.439"</i>				
HAND TAP	5	3B	6	17448	17449	5.25	2.00	2.1000	1.575	1.50
<b>2 3/4"-12 NS</b>						<i>Recommended Hole Size based on 75% Thread = 2.669"</i>				
HAND TAP	7	3B	6	17460	17461	5.50	2.00	2.1000	1.575	1.50
<b>3"-4 NC</b>						<i>Recommended Hole Size based on 75% Thread = 2.756"</i>				
HAND TAP	9	3B	6	17468	17469	9.75	4.56	2.5430	1.907	1.63
<b>3"-8 NS</b>						<i>Recommended Hole Size based on 75% Thread = 2.878"</i>				
HAND TAP	8	3B	6	17472	17473	9.75	4.56	2.5430	1.907	1.63
<b>3"-8 PIPE TAP NPT/F</b>						<i>Recommended Hole Size: NPT/F = 3.265"</i>				
NPT/F TAPER TAP			9	17475		6.00	2.63	2.6250	1.968	1.38
NPT/F TAPER INT THD TAP			9	17478		6.00	2.63	2.6250	1.968	1.38
GAGE L1 NPT PLG w/handle				24401						
GAGE L1 NPT RING				24399						
<b>3"-12 NS</b>						<i>Recommended Hole Size based on 75% Thread = 2.919"</i>				
HAND TAP	7	3B	8	17482	17483	5.50	2.00	2.1000	1.575	1.50
<b>3"-16 NS</b>						<i>Recommended Hole Size based on 75% Thread = 2.939"</i>				
HAND TAP	5	3B	8	17486	17487	5.50	2.00	2.1000	1.575	1.50



TAPS, DIES & GAGES

Click on Item Number below for Price List

SIZE/ DESCRIPTION	GH #	CLASS OF FIT	# FLUTES	ITEM #		OVERALL LENGTH	THREAD LENGTH	SHANK DIAMETER	SQUARE DIAMETER	SQUARE LENGTH
				PLUG	BOTTOM					
<b>3 1/8"-12 NS</b>						<i>Recommended Hole Size based on 75% Thread = 3.0442"</i>				
HAND TAP	7	2B	8	17490	17491	5.75	2.00	2.1000	1.575	1.50
<b>3 1/4"-8 NS</b>						<i>Recommended Hole Size based on 75% Thread = 3.1281"</i>				
HAND TAP	8	3B	6	17499	17500	10.00	4.56	2.7930	2.095	1.75
<b>3 1/4"-12 NS</b>						<i>Recommended Hole Size based on 75% Thread = 3.1692"</i>				
HAND TAP	7	3B	8	17503	17504	5.75	2.00	2.1000	1.575	1.50
<b>3 1/2"-4 NC</b>						<i>Recommended Hole Size based on 75% Thread = 3.256"</i>				
HAND TAP	9	3B	6	17507	17508	10.25	4.94	3.0080	2.256	2.00
<b>3 1/2"-8 NS</b>						<i>Recommended Hole Size based on 75% Thread = 3.378"</i>				
HAND TAP	8	3B	6	17511	17512	10.25	4.94	3.0080	2.256	2.00
<b>3 1/2"-8 PIPE TAP NPT/F</b>						<i>Recommended Hole Size: NPT/F = 3.75"</i>				
NPT/F TAPER TAP			9	17514		6.50	2.69	2.8125	2.108	1.50
NPT/F TAPER INT THD TAP			9	17517		6.50	2.69	2.8125	2.108	1.50
GAGE L1 NPT PLG w/handle				24404						
GAGE L1 NPT RING				24402						
<b>3 1/2"-12 NS</b>						<i>Recommended Hole Size based on 75% Thread = 3.4192"</i>				
HAND TAP	7	2B	8	17521	17522	5.75	2.00	2.1000	1.575	1.50
<b>3 3/4"-4 NC</b>						<i>Recommended Hole Size based on 75% Thread = 3.506"</i>				
HAND TAP	9	3B	10	17525	17526	10.50	5.31	3.2170	2.413	2.13
<b>3 3/4"-8 NS</b>						<i>Recommended Hole Size based on 75% Thread = 3.6281"</i>				
HAND TAP	8	3B	10	17529	17530	10.50	5.31	3.2170	2.413	2.13
<b>3 3/4"-12 NS</b>						<i>Recommended Hole Size based on 75% Thread = 3.6692"</i>				
HAND TAP	7	2B	10	17533	17534	6.00	2.00	2.1000	1.575	1.75
<b>4"-4 NC</b>						<i>Recommended Hole Size based on 75% Thread = 3.756"</i>				
HAND TAP	9	3B	10	17537	17538	10.75	5.31	3.4670	2.600	2.25
<b>4"-8 NS</b>						<i>Recommended Hole Size based on 75% Thread = 3.8781"</i>				
HAND TAP	8	3B	10	17541	17542	10.75	5.31	3.4670	2.600	2.25
<b>4"-8 PIPE TAP NPT/F</b>						<i>Recommended Hole Size: NPT/F = 4.25"</i>				
NPT/F TAPER TAP			9	17544		6.75	2.75	3.0000	2.250	1.56
NPT/F TAPER INT THD TAP			9	17547		6.75	2.75	3.0000	2.250	1.56
GAGE L1 NPT PLG w/handle				24407						
GAGE L1 NPT RING				24405						
<b>4"-12 NS</b>						<i>Recommended Hole Size based on 75% Thread = 3.9192"</i>				
HAND TAP	7	2B	10	17551	17552	6.00	2.00	2.1000	1.575	1.75

- The recommended hole sizes shown are reference values, and depending on specific tapping requirements and conditions, may have to be altered. North American Tool Corporation assumes no responsibility or liability of any kind as a result of the selection of tap hole sizes from this catalog.
- Note: For Unified, Metric and Pipe EXTENSION taps, S.T.I. tap and gage sizes, or SPECIAL taps NOT LISTED, please contact our Customer Service Dept.
- FOR QUESTIONS, PLEASE CONTACT OUR CUSTOMER SERVICE DEPT.



**DECIMAL AND MILLIMETER EQUIVALENT CHART**

FRACTION	DECIMAL	MILLIMETERS	FRACTION	DECIMAL	MILLIMETERS
1/64	.0156	.396	33/64	.5156	13.096
1/32	.0312	.793	17/32	.5312	13.493
3/64	.0468	1.190	35/64	.5468	13.890
1/16	.0625	1.587	9/16	.5625	14.287
5/64	.0781	1.984	37/64	.5781	14.684
3/32	.0937	2.381	19/32	.5937	15.081
7/64	.1093	2.778	39/64	.6093	15.478
1/8	.125	3.175	5/8	.625	15.875
9/64	.1406	3.571	41/64	.6406	16.271
5/32	.1562	3.968	21/32	.6562	16.668
11/64	.1718	4.365	43/64	.6718	17.065
3/16	.1875	4.762	11/16	.6875	17.462
13/64	.2031	5.159	45/64	.7031	17.859
7/32	.2187	5.556	23/32	.7187	18.256
15/64	.2343	5.953	47/64	.7343	18.653
1/4	.250	6.350	3/4	.750	19.050
17/64	.2656	6.746	49/64	.7656	19.446
9/32	.2812	7.143	25/32	.7812	19.843
19/64	.2968	7.540	51/64	.7968	20.240
5/16	.3125	7.937	13/16	.8125	20.637
21/64	.3281	8.334	53/64	.8281	21.034
11/32	.3437	8.731	27/32	.8437	21.431
23/64	.3593	9.128	55/64	.8593	21.828
3/8	.375	9.525	7/8	.875	22.225
25/64	.3906	9.921	57/64	.8906	22.621
13/32	.4062	10.318	29/32	.9062	23.018
27/64	.4218	10.715	59/64	.9218	23.415
7/16	.4375	11.112	15/16	.9375	23.812
29/64	.4531	11.509	61/64	.9531	24.209
15/32	.4687	11.906	31/32	.9687	24.606
31/64	.4843	12.303	63/64	.9843	25.003
1/2	.500	12.700	1"	1.000	25.400

**MILLIMETER PITCH TO THREADS PER INCH • METRIC PITCH CONVERSIONS**

PITCH IN MILLIMETERS	PITCH IN INCHES	THREADS PER INCH	BASIC HEIGHT	PITCH IN MILLIMETERS	PITCH IN INCHES	THREADS PER INCH	BASIC HEIGHT
0.25	0.00984	101.6000	0.00639	1.25	0.04921	20.3211	0.03196
0.30	0.01181	84.6668	0.00767	1.50	0.05906	16.9316	0.03836
0.35	0.01378	72.5689	0.00895	1.75	0.06890	14.5138	0.04475
0.40	0.01575	63.4921	0.01023	2.00	0.07874	12.7000	0.05114
0.45	0.01772	56.4334	0.01151	2.50	0.09843	10.1595	0.06393
0.50	0.01969	50.8000	0.01279	3.00	0.11811	8.4667	0.07671
0.60	0.02362	42.3370	0.01534	3.50	0.13780	7.2569	0.08950
0.70	0.02756	36.2845	0.01790	4.00	0.15748	6.3500	0.10229
0.75	0.02953	33.8639	0.01918	4.50	0.17717	5.6443	0.11508
0.80	0.03150	31.7460	0.02046	5.00	0.19685	5.0800	0.12785
0.90	0.03543	28.2247	0.02301	6.00	0.23622	4.2333	0.15344
1.00	0.03937	25.4000	0.02557				

TAPS, DIES & GAGES

Click on Item Number below for Price List

SIZE/ DESCRIPTION	D#	CLASS OF FIT	# FLUTES	ITEM #		OVERALL LENGTH	THREAD LENGTH	SHANK DIAMETER	SQUARE DIAMETER	SQUARE LENGTH
				PLUG	BOTTOM					
<b>M1.6 X 0.35</b>						<i>Recommended Hole Size based on 75% Thread = 1.25mm</i>				
HAND TAP	3	6H	2	20010		1.63	0.31	0.1410	0.110	0.19
SPIRAL POINT TAP	3	6H		20008		1.63	0.31	0.1410	0.110	0.19
GAGE - Taperlock Style		6H		25003						
GAGE - Reversible Style		6H		25645						
GAGE - Ring-Go		6g		25205						
GAGE - Ring-NoGo		6g		25206						
<b>M1.8 X 0.35</b>						<i>Recommended Hole Size based on 75% Thread = 1.45mm</i>				
HAND TAP	3	6H	2	20022	20023	1.69	0.38	0.1410	0.110	0.19
SPIRAL POINT TAP	3	6H		20020		1.69	0.38	0.1410	0.110	0.19
GAGE - Taperlock Style		6H		25008						
GAGE - Reversible Style		6H		25650						
GAGE - Ring-Go		6g		25210						
GAGE - Ring-NoGo		6g		25211						
<b>M2 X 0.4</b>						<i>Recommended Hole Size based on 75% Thread = 1.6mm</i>				
HAND TAP	3	6H	3	20034	20035	1.75	0.44	0.1410	0.110	0.19
SPIRAL POINT TAP	3	6H	2	20032		1.75	0.44	0.1410	0.110	0.19
GAGE - Taperlock Style		6H		25013						
GAGE - Reversible Style		6H		25655						
GAGE - Ring-Go		6g		25215						
GAGE - Ring-NoGo		6g		25216						
<b>M2.2 X 0.45</b>						<i>Recommended Hole Size based on 75% Thread = 1.75mm</i>				
HAND TAP	3	6H	3	20046	20047	1.75	0.44	0.1410	0.110	0.19
SPIRAL POINT TAP	3	6H	2	20044		1.75	0.44	0.1410	0.110	0.19
GAGE - Taperlock Style		6H		25018						
GAGE - Reversible Style		6H		25660						
GAGE - Ring-Go		6g		25220						
GAGE - Ring-NoGo		6g		25221						
<b>M2.5 X 0.45</b>						<i>Recommended Hole Size based on 75% Thread = 2.05mm</i>				
HAND TAP	3	6H	3	20058	20059	1.81	0.50	0.1410	0.110	0.19
SPIRAL POINT TAP	3	6H	2	20056		1.81	0.50	0.1410	0.110	0.19
HAND TAP	1	4H	3	20052	20053	1.81	0.50	0.1410	0.110	0.19
SPIRAL POINT TAP	1	4H	2	20050		1.81	0.50	0.1410	0.110	0.19
GAGE - Taperlock Style		6H		25023						
GAGE - Reversible Style		6H		25665						
GAGE - Ring-Go		6g		25225						
GAGE - Ring-NoGo		6g		25226						
<b>M2.6 X 0.45</b>						<i>Recommended Hole Size Based on 75% Thread = 2.15mm</i>				
HAND TAP	3	6H	3	21179	21180	1.81	0.50	0.1410	0.110	0.19
<b>M3 X 0.5</b>						<i>Recommended Hole Size Based on 75% Thread = 2.5mm TRU-FLO at 65% Thread = 2.78mm</i>				
HAND TAP	3	6H	3	20070	20071	1.94	0.63	0.1410	0.110	0.19
SPIRAL POINT TAP	3	6H	2	20068		1.94	0.63	0.1410	0.110	0.19
REGULAR SPIRAL FLUTE TAP	3	6H	2	20074	20075	1.94	0.63	0.1410	0.110	0.19
FAST SPIRAL FLUTE TAP	3	6H	2	20078	20079	1.94	0.63	0.1410	0.110	0.19
SPIRAL POINT TAP	5		2	21021		1.94	0.63	0.1410	0.110	0.19
+.076mm SPIRAL POINT TAP	7		2	20938		1.94	0.63	0.1410	0.110	0.19



Click on Item Number below for Price List

SIZE/ DESCRIPTION	D#	CLASS OF FIT	# FLUTES	ITEM #		OVERALL LENGTH	THREAD LENGTH	SHANK DIAMETER	SQUARE DIAMETER	SQUARE LENGTH
				PLUG	BOTTOM					
<b>M3 X 0.5</b>						<i>See Previous Page for Recommended Hole Size</i>				
HAND TAP	1	4H	3	20064	20065	1.94	0.63	0.1410	0.110	0.19
SPIRAL POINT TAP	1	4H	2	20062		1.94	0.63	0.1410	0.110	0.19
TRU-FLO FORM TAP	5	6H		19200	19201	1.94	0.31	0.1410	0.110	0.19
SOLID CARBIDE / HAND TAP	3	6H	3	43001	43002	1.94	0.31	0.1410	0.110	0.19
SOLID CARBIDE / SP PT TAP	3	6H	2	43003		1.94	0.31	0.1410	0.110	0.19
COST CUTTER DRILL/TAP	3	6H	2	29024		1.94	0.41	0.1410	0.110	0.19
R.H. ROUND DIE 20.6mm OD				13518						
GAGE - Taperlock Style		6H		25028						
GAGE - Reversible Style		6H		25670						
GAGE - Ring-Go		6g		25230						
GAGE - Ring-NoGo		6g		25231						
<b>M3.5 X 0.6</b>						<i>Recommended Hole Size Based on 75% Thread = 2.9mm TRU-FLO at 65% Thread = 3.24mm</i>				
HAND TAP	4	6H	3	20091	20092	2.00	0.69	0.1410	0.110	0.25
SPIRAL POINT TAP	4	6H	2	20089		2.00	0.69	0.1410	0.110	0.25
HAND TAP	1	4H	3	20085	20086	2.00	0.69	0.1410	0.110	0.25
SPIRAL POINT TAP	1	4H	2	20083		2.00	0.69	0.1410	0.110	0.25
REGULAR SPIRAL FLUTE TAP	4	6H	2	20101	20102	2.00	0.69	0.1410	0.110	0.25
FAST SPIRAL FLUTE TAP	4	6H	2	20105	20106	2.00	0.69	0.1410	0.110	0.25
6" EXTENSION HAND TAP	4	6H	3	20118	20119	6.00	0.69	0.1410	0.110	0.25
6" EXTENSION SPIRAL POINT TAP	4	6H	2	20116		6.00	0.69	0.1410	0.110	0.25
+.127mm HAND TAP	11	PLATING	3	20112	20113	2.00	0.69	0.1410	0.110	0.25
+.127mm SPIRAL POINT TAP	11	PLATING	2	20110		2.00	0.69	0.1410	0.110	0.25
TRU-FLO FORM TAP	6	6H		19202	19203	2.00	0.38	0.1410	0.110	0.19
SOLID CARBIDE / HAND TAP	4	6H	3	43005	43006	2.00	0.38	0.1410	0.110	0.19
SOLID CARBIDE / SP PT TAP	4	6H	2	43007		2.00	0.38	0.1410	0.110	0.19
COST CUTTER DRILL/TAP	4	6H	2	29025		2.00	0.44	0.1410	0.110	0.19
R.H. ROUND DIE 20.6mm OD				13522						
GAGE - Taperlock Style		6H		25033						
GAGE - Reversible Style		6H		25675						
GAGE - Ring-Go		6g		25235						
GAGE - Ring-NoGo		6g		25236						
<b>M4 X 0.75</b>						<i>Recommended Hole Size Based on 75% Thread = 3.25mm</i>				
HAND TAP	4	6H	4	21035	21036	2.13	0.75	0.1680	0.131	0.25
<b>M4 X 0.7</b>						<i>Recommended Hole Size Based on 75% Thread = 3.3mm TRU-FLO at 65% Thread = 3.69mm</i>				
HAND TAP	4	6H	4	20130	20131	2.13	0.75	0.1680	0.131	0.25
SPIRAL POINT TAP	4	6H	2	20128		2.13	0.75	0.1680	0.131	0.25
SPIRAL POINT TAP	5		2	21033		2.13	0.75	0.1680	0.131	0.25
HAND TAP	2	4H	4	20124	20125	2.13	0.75	0.1680	0.131	0.25
SPIRAL POINT TAP	2	4H	2	20122		2.13	0.75	0.1680	0.131	0.25
REGULAR SPIRAL FLUTE TAP	4	6H	2	20140	20141	2.13	0.75	0.1680	0.131	0.25
FAST SPIRAL FLUTE TAP	4	6H	3	20144	20145	2.13	0.75	0.1680	0.131	0.25
+.076mm SPIRAL POINT TAP	7		2	20923		2.13	0.75	0.1680	0.131	0.25
L.H. HAND TAP	4	6H	4	20136	20137	2.13	0.75	0.1680	0.131	0.25
6" EXTENSION HAND TAP	4	6H	4	20157	20158	6.00	0.75	0.1680	0.131	0.25
6" EXTENSION SPIRAL POINT TAP	4	6H	2	20155		6.00	0.75	0.1680	0.131	0.25



TAPS, DIES & GAGES

Click on Item Number below for Price List

SIZE/ DESCRIPTION	D#	CLASS OF FIT	# FLUTES	ITEM #		OVERALL LENGTH	THREAD LENGTH	SHANK DIAMETER	SQUARE DIAMETER	SQUARE LENGTH
				PLUG	BOTTOM					
<b>M4 X 0.7</b>										
<i>See Previous Page for Recommended Hole Size</i>										
+ .127mm HAND TAP	11	PLATING	4	20151	20152	2.13	0.75	0.1680	0.131	0.25
+ .127mm SPIRAL POINT TAP	11	PLATING	2	20149		2.13	0.75	0.1680	0.131	0.25
TRU-FLO FORM TAP	6	6H		19204	19205	2.13	0.38	0.1680	0.131	0.25
SOLID CARBIDE / HAND TAP	4	6H	4	43009	43010	2.13	0.38	0.1680	0.131	0.25
SOLID CARBIDE / SP PT TAP	4	6H	2	43011		2.13	0.38	0.1680	0.131	0.25
COST CUTTER DRILL/TAP	4	6H	2	29026		2.13	0.50	0.1680	0.131	0.25
R.H. ROUND DIE 20.6mm OD				13524						
L.H. ROUND DIE 20.6mm OD				13525						
GAGE - Taperlock Style		6H		25038						
GAGE - Reversible Style		6H		25680						
GAGE - Ring-Go		6g		25240						
GAGE - Ring-NoGo		6g		25241						
<b>M4.5 X 0.75</b>										
<i>Recommended Hole Size Based on 75% Thread = 3.75mm TRU-FLO at 65% Thread = 4.17mm</i>										
HAND TAP	4	6H	4	20169	20170	2.38	0.88	0.1940	0.152	0.25
SPIRAL POINT TAP	4	6H	2	20167		2.38	0.88	0.1940	0.152	0.25
HAND TAP	2	4H	4	20163	20164	2.38	0.88	0.1940	0.152	0.25
SPIRAL POINT TAP	2	4H	2	20161		2.38	0.88	0.1940	0.152	0.25
REGULAR SPIRAL FLUTE TAP	4	6H	2	20179	20180	2.38	0.88	0.1940	0.152	0.25
FAST SPIRAL FLUTE TAP	4	6H	3	20183	20184	2.38	0.88	0.1940	0.152	0.25
L.H. HAND TAP	4	6H	4	20175	20176	2.38	0.88	0.1940	0.152	0.25
6" EXTENSION HAND TAP	4	6H	4	20196	20197	6.00	0.88	0.1940	0.152	0.25
6" EXTENSION SPIRAL POINT TAP	4	6H	2	20194		6.00	0.88	0.1940	0.152	0.25
+ .127mm HAND TAP	11	PLATING	4	20190	20191	2.38	0.88	0.1940	0.152	0.25
+ .127mm SPIRAL POINT TAP	11	PLATING	2	20188		2.38	0.88	0.1940	0.152	0.25
TRU-FLO FORM TAP	6	6H		19206	19207	2.38	0.50	0.1940	0.152	0.25
SOLID CARBIDE / HAND TAP	4	6H	4	43013	43014	2.38	0.50	0.1940	0.152	0.25
SOLID CARBIDE / SP PT TAP	4	6H	2	43015		2.38	0.50	0.1940	0.152	0.25
COST CUTTER DRILL/TAP	4	6H	2	29027		2.38	0.63	0.1940	0.152	0.25
R.H. ROUND DIE 20.6mm OD				13528						
GAGE - Taperlock Style		6H		25043						
GAGE - Reversible Style		6H		25685						
GAGE - Ring-Go		6g		25245						
GAGE - Ring-NoGo		6g		25246						
<b>M5 X 0.9</b>										
<i>Recommended Hole Size Based on 75% Thread = 4.1mm</i>										
HAND TAP	3	4H	4	21184	21185	2.38	0.88	0.1940	0.152	0.25
SPIRAL POINT TAP	3	4H	2	21186		2.38	0.88	0.1940	0.152	0.25
<b>M5 X 0.8</b>										
<i>Recommended Hole Size Based on 75% Thread = 4.2mm TRU-FLO at 65% Thread = 4.65mm</i>										
HAND TAP	4	6H	4	20208	20209	2.38	0.88	0.1940	0.152	0.25
SPIRAL POINT TAP	4	6H	2	20206		2.38	0.88	0.1940	0.152	0.25
HAND TAP	2	4H	4	20202	20203	2.38	0.88	0.1940	0.152	0.25
SPIRAL POINT TAP	2	4H	2	20200		2.38	0.88	0.1940	0.152	0.25
REGULAR SPIRAL FLUTE TAP	4	6H	2	20218	20219	2.38	0.88	0.1940	0.152	0.25
FAST SPIRAL FLUTE TAP	4	6H	3	20222	20223	2.38	0.88	0.1940	0.152	0.25
+ .076mm SPIRAL POINT TAP	7		2	20924		2.38	0.88	0.1940	0.152	0.25



Click on Item Number  
below for Price List

SIZE/ DESCRIPTION	D#	CLASS OF FIT	# FLUTES	ITEM #		OVERALL LENGTH	THREAD LENGTH	SHANK DIAMETER	SQUARE DIAMETER	SQUARE LENGTH
				PLUG	BOTTOM					
<b>M5 X 0.8</b>						<i>See Previous Page for Recommended Hole Size</i>				
L.H. HAND TAP	4	6H	4	20214	20215	2.38	0.88	0.1940	0.152	0.25
6" EXTENSION HAND TAP	4	6H	4	20235	20236	6.00	0.88	0.1940	0.152	0.25
6" EXTENSION SPIRAL POINT TAP	4	6H	2	20233		6.00	0.88	0.1940	0.152	0.25
+ .127mm HAND TAP	11	PLATING	4	20229	20230	2.38	0.88	0.1940	0.152	0.25
+ .127mm SPIRAL POINT TAP	11	PLATING	2	20227		2.38	0.88	0.1940	0.152	0.25
TRU-FLO FORM TAP	7	6H		19208	19209	2.38	0.50	0.1940	0.152	0.25
SOLID CARBIDE / HAND TAP	4	6H	4	43017	43018	2.38	0.50	0.1940	0.152	0.25
SOLID CARBIDE / SP PT TAP	4	6H	2	43019		2.38	0.50	0.1940	0.152	0.25
COST CUTTER DRILL/TAP	4	6H	2	29028		2.38	0.63	0.1940	0.152	0.25
TiN COAT / +.076mm SP PT TAP	7		2	55009		2.38	0.88	0.1940	0.152	0.25
R.H. ROUND DIE 20.6mm OD				13530						
L.H. ROUND DIE 20.6mm OD				13531						
GAGE - Taperlock Style		6H		25048						
GAGE - Reversible Style		6H		25690						
GAGE - Ring-Go		6g		25250						
GAGE - Ring-NoGo		6g		25251						
<b>M5 X 0.5</b>						<i>Recommended Hole Size Based on 75% Thread = 4.5mm</i>				
HAND TAP	3	6H	4	20910	20911	2.38	0.88	0.1940	0.152	0.25
SPIRAL POINT TAP	3	6H	2	20912		2.38	0.88	0.1940	0.152	0.25
GAGE - Taperlock Style		6H		22780						
GAGE - Reversible Style		6H		22781						
GAGE - Ring-Go		6g		22782						
GAGE - Ring-NoGo		6g		22783						
<b>M5.5 X 0.9</b>						<i>Recommended Hole Size Based on 75% Thread = 4.6mm</i>				
HAND TAP	3	4H	4	21189	21190	2.38	0.94	0.2200	0.165	0.28
SPIRAL POINT TAP	3	4H	2	21191		2.38	0.94	0.2200	0.165	0.28
<b>M6 X 1.0</b>						<i>Recommended Hole Size Based on 75% Thread = 5mm TRU-FLO at 65% Thread = 5.56mm</i>				
HAND TAP	5	6H	4	20247	20248	2.50	1.00	0.2550	0.191	0.31
SPIRAL POINT TAP	5	6H	2	20245		2.50	1.00	0.2550	0.191	0.31
HAND TAP	3	4H	4	20241	20242	2.50	1.00	0.2550	0.191	0.31
SPIRAL POINT TAP	3	4H	2	20239		2.50	1.00	0.2550	0.191	0.31
REGULAR SPIRAL FLUTE TAP	5	6H	3	20257	20258	2.50	1.00	0.2550	0.191	0.31
FAST SPIRAL FLUTE TAP	5	6H	3	20261	20262	2.50	1.00	0.2550	0.191	0.31
L.H. HAND TAP	5	6H	4	20253	20254	2.50	1.00	0.2550	0.191	0.31
6" EXTENSION HAND TAP	5	6H	4	20274	20275	6.00	1.00	0.2550	0.191	0.31
6" EXTENSION SPIRAL POINT TAP	5	6H	2	20272		6.00	1.00	0.2550	0.191	0.31
+ .127mm HAND TAP	11	PLATING	4	20268	20269	2.50	1.00	0.2550	0.191	0.31
+ .127mm SPIRAL POINT TAP	11	PLATING	2	20266		2.50	1.00	0.2550	0.191	0.31
TRU-FLO FORM TAP	8	6H		19210	19211	2.50	0.63	0.2550	0.191	0.31
SOLID CARBIDE / HAND TAP	5	6H	4	43021	43022	2.50	0.63	0.2550	0.191	0.31
SOLID CARBIDE / SP PT TAP	5	6H	2	43023		2.50	0.63	0.2550	0.191	0.31
COST CUTTER DRILL/TAP	5	6H	2	29029		2.50	0.78	0.2550	0.191	0.31
R.H. ROUND DIE 25.4mm OD				13538						
L.H. ROUND DIE 25.4mm OD				13539						

TAPS, DIES & GAGES

Click on Item Number below for Price List

SIZE/ DESCRIPTION	D#	CLASS OF FIT	# FLUTES	ITEM #		OVERALL LENGTH	THREAD LENGTH	SHANK DIAMETER	SQUARE DIAMETER	SQUARE LENGTH
				PLUG	BOTTOM					
<b>M6 X 1.0</b>						<i>See Previous Page for Recommended Hole Size</i>				
GAGE - Taperlock Style		6H		25053						
GAGE - Reversible Style		6H		25695						
GAGE - Ring-Go		6g		25255						
GAGE - Ring-NoGo		6g		25256						
<b>M6 X 0.75</b>						<i>Recommended Hole Size Based on 75% Thread = 5.25mm</i>				
HAND TAP	3	4H	4	20280	20281	2.50	1.00	0.2550	0.191	0.31
SPIRAL POINT TAP	3	4H	2	20278		2.50	1.00	0.2550	0.191	0.31
R.H. ROUND DIE 25.4mm OD				13536						
GAGE - Taperlock Style		6H		22792						
GAGE - Reversible Style		6H		22793						
GAGE - Ring-Go		6g		22794						
GAGE - Ring-NoGo		6g		22795						
<b>M6 X 0.5</b>						<i>Recommended Hole Size Based on 75% Thread = 5.5mm</i>				
HAND TAP	3	6H	4	20976	20977	2.50	1.00	0.2550	0.191	0.31
TiN COAT / BTM TAP	3	6H	4		55011	2.50	1.00	0.2550	0.191	0.31
<b>M7 X 1.0</b>						<i>Recommended Hole Size Based on 75% Thread = 6mm TRU-FLO at 65% Thread = 6.56mm</i>				
HAND TAP	5	6H	4	20290	20291	2.72	1.13	0.3180	0.238	0.38
SPIRAL POINT TAP	5	6H	2	20288		2.72	1.13	0.3180	0.238	0.38
L.H. HAND TAP	5	6H	4	20295	20296	2.72	1.13	0.3180	0.238	0.38
+.127mm HAND TAP	11	PLATING	4	20309	20310	2.72	1.13	0.3180	0.238	0.38
+.127mm SPIRAL POINT TAP	11	PLATING	2	20307		2.72	1.13	0.3180	0.238	0.38
TRU-FLO FORM TAP	8	6H		19212	19213	2.72	0.69	0.3180	0.238	0.38
SOLID CARBIDE / HAND TAP	5	6H	4	43025	43026	2.72	0.69	0.3180	0.238	0.38
SOLID CARBIDE / SP PT TAP	5	6H	2	43027		2.72	0.69	0.3180	0.238	0.38
COST CUTTER DRILL/TAP	5	6H	2	29030		2.72	0.94	0.3180	0.238	0.38
R.H. ROUND DIE 25.4mm OD				13542						
L.H. ROUND DIE 25.4mm OD				13543						
GAGE - Taperlock Style		6H		25058						
GAGE - Reversible Style		6H		25700						
GAGE - Ring-Go		6g		25260						
GAGE - Ring-NoGo		6g		25261						
<b>M8 X 1.25</b>						<i>Recommended Hole Size Based on 75% Thread = 6.75mm TRU-FLO at 65% Thread = 7.45mm</i>				
HAND TAP	5	6H	4	20324	20325	2.72	1.13	0.3180	0.238	0.38
SPIRAL POINT TAP	5	6H	2	20322		2.72	1.13	0.3180	0.238	0.38
HAND TAP	3	4H	4	20319	20320	2.72	1.13	0.3180	0.238	0.38
SPIRAL POINT TAP	3	4H	2	20317		2.72	1.13	0.3180	0.238	0.38
REGULAR SPIRAL FLUTE TAP	5	6H	3	20333	20334	2.72	1.13	0.3180	0.238	0.38
FAST SPIRAL FLUTE TAP	5	6H	3	20337	20338	2.72	1.13	0.3180	0.238	0.38
L.H. HAND TAP	5	6H	4	20329	20330	2.72	1.13	0.3180	0.238	0.38
6" EXTENSION HAND TAP	5	6H	4	20348	20349	6.00	1.13	0.3180	0.238	0.38
6" EXTENSION SPIRAL POINT TAP	5	6H	2	21022		6.00	1.13	0.3180	0.238	0.38
+.127mm HAND TAP	11	PLATING	4	20343	20344	2.72	1.13	0.3180	0.238	0.38
+.127mm SPIRAL POINT TAP	11	PLATING	2	20341		2.72	1.13	0.3180	0.238	0.38
TRU-FLO FORM TAP	9	6H		19214	19215	2.72	0.69	0.3180	0.238	0.38





Click on Item Number below for Price List

SIZE/ DESCRIPTION	D#	CLASS OF FIT	# FLUTES	ITEM #		OVERALL LENGTH	THREAD LENGTH	SHANK DIAMETER	SQUARE DIAMETER	SQUARE LENGTH
				PLUG	BOTTOM					
<b>M8 X 1.25</b>						<i>See Previous Page for Recommended Hole Size</i>				
SOLID CARBIDE / HAND TAP	5	6H	4	43029	43030	2.72	0.69	0.3180	0.238	0.38
SOLID CARBIDE / SP PT TAP	5	6H	2	43031		2.72	0.69	0.3180	0.238	0.38
COST CUTTER DRILL/TAP	5	6H	2	29031		2.72	0.94	0.3180	0.238	0.38
TiN COAT / PLUG TAP	5	6H	4	55002		2.72	1.13	0.3180	0.238	0.38
TiN COAT / SP PT TAP	5	6H	2	55001		2.72	1.13	0.3180	0.238	0.38
R.H. ROUND DIE 25.4mm OD				13546						
L.H. ROUND DIE 25.4mm OD				13547						
GAGE - Taperlock Style		6H		25063						
GAGE - Reversible Style		6H		25705						
GAGE - Ring-Go		6g		25265						
GAGE - Ring-NoGo		6g		25266						
<b>M8 X 1.0</b>						<i>Recommended Hole Size Based on 75% Thread = 7mm TRU-FLO at 65% Thread = 7.56mm</i>				
HAND TAP	5	6H	4	20358	20359	2.72	1.13	0.3180	0.238	0.38
SPIRAL POINT TAP	5	6H	2	20356		2.72	1.13	0.3180	0.238	0.38
HAND TAP	3	4H	4	20353	20354	2.72	1.13	0.3180	0.238	0.38
SPIRAL POINT TAP	3	4H	2	20351		2.72	1.13	0.3180	0.238	0.38
L.H. HAND TAP	5	6H	4	20363	20364	2.72	1.13	0.3180	0.238	0.38
+.127mm HAND TAP	11	PLATING	4	20376	20377	2.72	1.13	0.3180	0.238	0.38
+.127mm SPIRAL POINT TAP	11	PLATING	2	20374		2.72	1.13	0.3180	0.238	0.38
REGULAR SPIRAL FLUTE TAP	5	6H	3	20367	20368	2.72	1.13	0.3180	0.238	0.38
FAST SPIRAL FLUTE TAP	5	6H	3	20371	20372	2.72	1.13	0.3180	0.238	0.38
TRU-FLO FORM TAP	8	6H		19216	19217	2.72	0.69	0.3180	0.238	0.38
SOLID CARBIDE / HAND TAP	5	6H	4	43033	43034	2.72	0.69	0.3180	0.238	0.38
R.H. ROUND DIE 25.4mm OD				13548						
L.H. ROUND DIE 25.4mm OD				13549						
GAGE - Taperlock Style		6H		25068						
GAGE - Reversible Style		6H		25710						
GAGE - Ring-Go		6g		25270						
GAGE - Ring-NoGo		6g		25271						
<b>M8 X 0.75</b>						<i>Recommended Hole Size Based on 75% Thread = 7.25mm</i>				
HAND TAP	5	6H	4	20941	20942	2.72	1.13	0.3180	0.238	0.38
GAGE - Taperlock Style		6H		22820						
GAGE - Reversible Style		6H		22821						
GAGE - Ring-Go		6g		22822						
GAGE - Ring-NoGo		6g		22823						
<b>M8 X 0.5</b>						<i>Recommended Hole Size Based on 75% Thread = 7.5mm</i>				
HAND TAP	4	6H	4	21024	21025	2.72	1.13	0.3180	0.238	0.38
<b>M9 X 1.25</b>						<i>Recommended Hole Size Based on 75% Thread = 7.75mm</i>				
HAND TAP	5	6H	4	21038	21039	2.94	1.25	0.3810	0.286	0.44
GAGE - Taperlock Style		6H		22832						
GAGE - Reversible Style		6H		22833						
GAGE - Ring-Go		6g		22834						
GAGE - Ring-NoGo		6g		22835						
<b>M9 X 1.0</b>						<i>Recommended Hole Size Based on 75% Thread = 8mm</i>				
HAND TAP	5	6H		21041	21042	2.94	1.25	0.3810	0.286	0.44



TAPS, DIES & GAGES

Click on Item Number below for Price List

SIZE/ DESCRIPTION	D#	CLASS OF FIT	# FLUTES	ITEM #		OVERALL LENGTH	THREAD LENGTH	SHANK DIAMETER	SQUARE DIAMETER	SQUARE LENGTH
				PLUG	BOTTOM					
<b>M9 X 1.0</b>						<i>See Previous Page for Recommended Hole Size</i>				
GAGE - Taperlock Style		6H		22844						
GAGE - Reversible Style		6H		22845						
GAGE - Ring-Go		6g		22846						
GAGE - Ring-NoGo		6g		22847						
<b>M10 X 1.5</b>						<i>Recommended Hole Size Based on 75% Thread = 8.5mm TRU-FLO at 65% Thread = 9.34mm</i>				
HAND TAP	6	6H	4	20391	20392	2.94	1.25	0.3810	0.286	0.44
SPIRAL POINT TAP	6	6H	3	20389		2.94	1.25	0.3810	0.286	0.44
HAND TAP	3	4H	4	20386	20387	2.94	1.25	0.3810	0.286	0.44
SPIRAL POINT TAP	3	4H	3	20384		2.94	1.25	0.3810	0.286	0.44
+.076 SPIRAL POINT TAP	7		3	21043		2.94	1.25	0.3810	0.286	0.44
REGULAR SPIRAL FLUTE TAP	6	6H	3	20400	20401	2.94	1.25	0.3810	0.286	0.44
FAST SPIRAL FLUTE TAP	6	6H	3	20404	20405	2.94	1.25	0.3810	0.286	0.44
L.H. HAND TAP	6	6H	4	20396	20397	2.94	1.25	0.3810	0.286	0.44
6" EXTENSION HAND .323 SHK TAP	6	6H	4	21194	21195	6.00	1.25	0.3230	0.242	0.41
6" EXTENSION SP PT .323 SHK TAP	6	6H	3	21196		6.00	1.25	0.3230	0.242	0.41
6" EXTENSION HAND TAP	6	6H	4	20415	20416	6.00	1.25	0.3810	0.286	0.44
6" EXTENSION SPIRAL POINT TAP	6	6H	3	21026		6.00	1.25	0.3810	0.286	0.44
+.127mm HAND TAP	11	PLATING	4	20410	20411	2.94	1.25	0.3810	0.286	0.44
+.127mm SPIRAL POINT TAP	11	PLATING	3	20408		2.94	1.25	0.3810	0.286	0.44
TRU-FLO FORM TAP	10	6H		19218	19219	2.94	0.75	0.3810	0.286	0.44
SOLID CARBIDE / HAND TAP	6	6H	4	43037	43038	2.94	0.75	0.3810	0.286	0.44
SOLID CARBIDE / SP PT TAP	6	6H	3	43039		2.94	0.75	0.3810	0.286	0.44
COST CUTTER DRILL/TAP	6	6H	2	29032		2.94	1.13	0.3810	0.286	0.44
TiN COAT / SP PT x 6" TAP	6	6H	3	55012		6.00	1.25	0.3810	0.286	0.44
R.H. ROUND DIE 25.4mm OD				13556						
L.H. ROUND DIE 38.1mm OD				13557						
GAGE - Taperlock Style		6H		25073						
GAGE - Reversible Style		6H		25715						
GAGE - Ring-Go		6g		25275						
GAGE - Ring-NoGo		6g		25276						
<b>M10 X 1.25</b>						<i>Recommended Hole Size Based on 75% Thread = 8.75mm TRU-FLO at 65% Thread = 9.45mm</i>				
HAND TAP	3	4H	4	20420	20421	2.94	1.25	0.3810	0.286	0.44
SPIRAL POINT TAP	3	4H	3	20418		2.94	1.25	0.3810	0.286	0.44
HAND TAP	5	6H	4	20425	20426	2.94	1.25	0.3810	0.286	0.44
SPIRAL POINT TAP	5	6H	3	20423		2.94	1.25	0.3810	0.286	0.44
REGULAR SPIRAL FLUTE TAP	5	6H	3	20434	20435	2.94	1.25	0.3810	0.286	0.44
FAST SPIRAL FLUTE TAP	5	6H	3	20438	20439	2.94	1.25	0.3810	0.286	0.44
L.H. HAND TAP	5	6H	4	20430	20431	2.94	1.25	0.3810	0.286	0.44
+.127mm HAND TAP	11	PLATING	4	20443	20444	2.94	1.25	0.3810	0.286	0.44
+.127mm SPIRAL POINT TAP	11	PLATING	3	20441		2.94	1.25	0.3810	0.286	0.44
TRU-FLO FORM TAP	9	6H		19220	19221	2.94	0.75	0.3810	0.286	0.44
SOLID CARBIDE HAND TAP	5	6H	4	43041	43042	2.94	0.75	0.3810	0.286	0.44
SOLID CARBIDE SP PT TAP	5	6H	3	43043		2.94	0.75	0.3810	0.286	0.44



Click on Item Number below for Price List

SIZE/ DESCRIPTION	D#	CLASS OF FIT	# FLUTES	ITEM #		OVERALL LENGTH	THREAD LENGTH	SHANK DIAMETER	SQUARE DIAMETER	SQUARE LENGTH
				PLUG	BOTTOM					
<b>M10 X 1.25</b>						<i>See Previous Page for Recommended Hole Size</i>				
TiN COAT / SP PT TAP	5	6H	3	55003		2.94	1.25	0.3810	0.286	0.44
R.H. ROUND DIE 38.1mm OD				13558						
L.H. ROUND DIE 38.1mm OD				13559						
GAGE - Taperlock Style		6H		25078						
GAGE - Reversible Style		6H		25720						
GAGE - Ring-Go		6g		25150						
GAGE - Ring-NoGo		6g		25151						
<b>M10 X 1.0</b>						<i>Recommended Hole Size Based on 75% Thread = 9mm</i>				
SPARK PL HAND TAP	3		4	20448	20449	2.94	1.25	0.3810	0.286	0.44
HAND TAP	5	6H	4	20945	20946	2.94	1.25	0.3810	0.286	0.44
L.H. HAND TAP	5	6H	4	20949	20950	2.94	1.25	0.3810	0.286	0.44
SPIRAL POINT TAP	5	6H	3	20978		2.94	1.25	0.3810	0.286	0.44
R.H. ROUND DIE 38.1mm OD				13554						
GAGE - Taperlock Style		6H		22864						
GAGE - Reversible Style		6H		22865						
GAGE - Ring-Go		6g		22866						
GAGE - Ring-NoGo		6g		22867						
<b>M11 X 1.5</b>						<i>Recommended Hole Size Based on 75% Thread = 9.5mm</i>				
HAND TAP	6	6H	4	20453	20454	3.16	1.44	0.3230	0.242	0.41
SPIRAL POINT TAP	6	6H	3	20451		3.16	1.44	0.3230	0.242	0.41
R.H. ROUND DIE 38.1mm OD				13560						
GAGE - Taperlock Style		6H		22876						
GAGE - Reversible Style		6H		22877						
GAGE - Ring-Go		6g		22878						
GAGE - Ring-NoGo		6g		22879						
<b>M11 X 1.0</b>						<i>Recommended Hole Size Based on 75% Thread = 10mm</i>				
HAND TAP	5	6H	4	20985	20986	3.16	1.44	0.3230	0.242	0.41
GAGE - Taperlock Style		6H		22888						
GAGE - Reversible Style		6H		22889						
GAGE - Ring-Go		6g		22890						
GAGE - Ring-NoGo		6g		22891						
<b>M12 X 1.75</b>						<i>Recommended Hole Size Based on 75% Thread = 10.25mm TRU-FLO at 65% Thread = 11.23mm</i>				
HAND TAP	6	6H	4	20463	20464	3.38	1.66	0.3670	0.275	0.44
SPIRAL POINT TAP	6	6H	3	20461		3.38	1.66	0.3670	0.275	0.44
HAND TAP	3	4H	4	20458	20459	3.38	1.66	0.3670	0.275	0.44
SPIRAL POINT TAP	3	4H	3	20456		3.38	1.66	0.3670	0.275	0.44
REGULAR SPIRAL FLUTE TAP	6	6H	3	20472	20473	3.38	1.66	0.3670	0.275	0.44
FAST SPIRAL FLUTE TAP	6	6H	3	20476	20477	3.38	1.66	0.3670	0.275	0.44
L.H. HAND TAP	6	6H	4	20468	20469	3.38	1.66	0.3670	0.275	0.44
6" EXTENSION HAND TAP	6	6H	4	20487	20488	6.00	1.66	0.3670	0.275	0.44
6" EXTENSION SP PT TAP	6	6H	3	20913		6.00	1.66	0.3670	0.275	0.44
+ .127mm HAND TAP	11	PLATING	4	20482	20483	3.38	1.66	0.3670	0.275	0.44
+ .127mm SPIRAL POINT TAP	11	PLATING	3	20480		3.38	1.66	0.3670	0.275	0.44
TRU-FLO FORM TAP	11	6H		19222	19223	3.38	0.94	0.3670	0.275	0.44
SOLID CARBIDE / HAND TAP	6	6H	4	43045	43046	3.38	0.94	0.3670	0.275	0.44
SOLID CARBIDE / SP PT TAP	6	6H	3	43047		3.38	0.94	0.3670	0.275	0.44



TAPS, DIES & GAGES

Click on Item Number below for Price List

SIZE/ DESCRIPTION	D#	CLASS OF FIT	# FLUTES	ITEM #		OVERALL LENGTH	THREAD LENGTH	SHANK DIAMETER	SQUARE DIAMETER	SQUARE LENGTH
				PLUG	BOTTOM					
<b>M12 X 1.75</b>						<i>See Previous Page for Recommended Hole Size</i>				
COST CUTTER DRILL/TAP	6	6H	2	29033		4.06	1.38	0.3670	0.275	0.44
TiN COAT / SP PT x 6" TAP	6	6H	3	55008		6.00	1.66	0.3670	0.275	0.44
R.H. ROUND DIE 38.1mm OD				13564						
L.H. ROUND DIE 38.1mm OD				13565						
GAGE - Taperlock Style		6H		25083						
GAGE - Reversible Style		6H		25725						
GAGE - Ring-Go		6g		25280						
GAGE - Ring-NoGo		6g		25281						
<b>M12 X 1.5</b>						<i>Recommended Hole Size Based on 75% Thread = 10.50mm</i>				
HAND TAP	6	6H	4	20906	20907	3.38	1.66	0.3670	0.275	0.44
SPIRAL POINT TAP	6	6H	3	21027		3.38	1.66	0.3670	0.275	0.44
TiN COAT / SP PT TAP	6	6H	3	55013		3.38	1.66	0.3670	0.275	0.44
GAGE - Taperlock Style		6H		22900						
GAGE - Reversible Style		6H		22901						
GAGE - Ring-Go		6g		22902						
GAGE - Ring-NoGo		6g		22903						
<b>M12 X 1.25</b>						<i>Recommended Hole Size Based on 75% Thread = 10.75mm TRU-FLO at 65% Thread = 11.45mm</i>				
HAND TAP	5	6H	4	20497	20498	3.38	1.66	0.3670	0.275	0.44
SPIRAL POINT TAP	5	6H	3	20495		3.38	1.66	0.3670	0.275	0.44
HAND TAP	3	4H	4	20492	20493	3.38	1.66	0.3670	0.275	0.44
SPIRAL POINT TAP	3	4H	3	20490		3.38	1.66	0.3670	0.275	0.44
REGULAR SPIRAL FLUTE TAP	5	6H	3	20506	20507	3.38	1.66	0.3670	0.275	0.44
FAST SPIRAL FLUTE TAP	5	6H	3	20510	20511	3.38	1.66	0.3670	0.275	0.44
L.H. HAND TAP	5	6H	4	20502	20503	3.38	1.66	0.3670	0.275	0.44
+.127mm HAND TAP	11	PLATING	4	20515	20516	3.38	1.66	0.3670	0.275	0.44
TRU-FLO FORM TAP	10	6H		19224	19225	3.38	0.94	0.3670	0.275	0.44
TiN COAT / REG SPIRAL FLT TAP	5	6H	3	55004		3.38	1.66	0.3670	0.275	0.44
R.H. ROUND DIE 38.1mm OD				13566						
L.H. ROUND DIE 38.1mm OD				13567						
GAGE - Taperlock Style		6H		25088						
GAGE - Reversible Style		6H		25730						
GAGE - Ring-Go		6g		25285						
GAGE - Ring-NoGo		6g		25286						
<b>M12 X 1.0</b>						<i>Recommended Hole Size Based on 75% Thread = 11mm</i>				
HAND TAP	5	6H	4	20890	20891	3.38	1.66	0.3670	0.275	0.44
SPIRAL POINT TAP	5	6H	3	20914		3.38	1.66	0.3670	0.275	0.44
GAGE - Taperlock Style		6H		22920						
GAGE - Reversible Style		6H		22921						
GAGE - Ring-Go		6g		22922						
GAGE - Ring-NoGo		6g		22923						
<b>M14 X 2.0</b>						<i>Recommended Hole Size Based on 75% Thread = 12mm TRU-FLO at 65% Thread = 13.13mm</i>				
HAND TAP	7	6H	4	20530	20531	3.59	1.66	0.4290	0.322	0.50
SPIRAL POINT TAP	7	6H	3	20528		3.59	1.66	0.4290	0.322	0.50
HAND TAP	3	4H	4	20525	20526	3.59	1.66	0.4290	0.322	0.50
SPIRAL POINT TAP	3	4H	3	20523		3.59	1.66	0.4290	0.322	0.50



Click on Item Number below for Price List

SIZE/ DESCRIPTION	D#	CLASS OF FIT	# FLUTES	ITEM #		OVERALL LENGTH	THREAD LENGTH	SHANK DIAMETER	SQUARE DIAMETER	SQUARE LENGTH
				PLUG	BOTTOM					
<b>M14 X 2.0</b>						<i>See Previous Page for Recommended Hole Size</i>				
L.H. HAND TAP	7	6H	4	20535	20536	3.59	1.66	0.4290	0.322	0.50
TRU-FLO FORM TAP	12	6H		19226	19227	3.59	1.00	0.4290	0.322	0.50
R.H. ROUND DIE 38.1mm OD				13570						
L.H. ROUND DIE 38.1mm OD				13571						
GAGE - Taperlock Style		6H		25093						
GAGE - Reversible Style		6H		25735						
GAGE - Ring-Go		6g		25290						
GAGE - Ring-NoGo		6g		25291						
<b>M14 X 1.5</b>						<i>Recommended Hole Size Based on 75% Thread = 12.5mm TRU-FLO at 65% Thread = 13.34mm</i>				
HAND TAP	6	6H	4	20546	20547	3.59	1.66	0.4290	0.322	0.50
SPIRAL POINT TAP	6	6H	3	20543		3.59	1.66	0.4290	0.322	0.50
HAND TAP	3	4H	4	20540	20541	3.59	1.66	0.4290	0.322	0.50
SPIRAL POINT TAP	3	4H	3	20538		3.59	1.66	0.4290	0.322	0.50
L.H. HAND TAP	6	6H	4	20551	20552	3.59	1.66	0.4290	0.322	0.50
TRU-FLO FORM TAP	11	6H		19228	19229	3.59	1.00	0.4290	0.322	0.50
R.H. ROUND DIE 38.1mm OD				13572						
L.H. ROUND DIE 38.1mm OD				13573						
GAGE - Taperlock Style		6H		25098						
GAGE - Reversible Style		6H		25740						
GAGE - Ring-Go		6g		25295						
GAGE - Ring-NoGo		6g		25296						
<b>M14 X 1.25</b>						<i>Recommended Hole Size Based on 75% Thread = 12.75mm</i>				
SPARK PL HAND TAP	4		4	20556	20557	3.59	1.66	0.4290	0.322	0.50
R.H. ROUND DIE 38.1mm OD				13568						
GAGE - Taperlock Style		6H		22940						
GAGE - Reversible Style		6H		22941						
GAGE - Ring-Go		6g		22942						
GAGE - Ring-NoGo		6g		22943						
<b>M14 X 1.0</b>						<i>Recommended Hole Size Based on 75% Thread = 13mm</i>				
HAND TAP	5	6H	4	20902	20903	3.59	1.66	0.4290	0.322	0.50
GAGE - Taperlock Style		6H		22944						
GAGE - Ring-Go		6g		22946						
GAGE - Ring-NoGo		6g		22947						
<b>M15 X 1.0</b>						<i>Recommended Hole Size Based on 75% Thread = 14mm</i>				
HAND TAP	5	6H	4	20989	20990	3.81	1.81	0.4800	0.360	0.56
GAGE - Taperlock Style		6H		22948						
GAGE - Reversible Style		6H		22949						
GAGE - Ring-Go		6g		22950						
GAGE - Ring-NoGo		6g		22951						
<b>M16 X 2.0</b>						<i>Recommended Hole Size Based on 75% Thread = 14mm TRU-FLO at 65% Thread = 15.13mm</i>				
HAND TAP	7	6H	4	20566	20567	3.81	1.81	0.4800	0.360	0.56
SPIRAL POINT TAP	7	6H	3	20564		3.81	1.81	0.4800	0.360	0.56
HAND TAP	4	4H	4	20561	20562	3.81	1.81	0.4800	0.360	0.56
SPIRAL POINT TAP	4	4H	3	20559		3.81	1.81	0.4800	0.360	0.56



TAPS, DIES & GAGES

Click on Item Number below for Price List

SIZE/ DESCRIPTION	D#	CLASS OF FIT	# FLUTES	ITEM #		OVERALL LENGTH	THREAD LENGTH	SHANK DIAMETER	SQUARE DIAMETER	SQUARE LENGTH
				PLUG	BOTTOM					
<b>M16 X 2.0</b>						<i>See Previous Page for Recommended Hole Size</i>				
L.H. HAND TAP	7	6H	4	20571	20572	3.81	1.81	0.4800	0.360	0.56
6" EXTENSION HAND TAP	7	6H	4	20953	20954	6.00	1.81	0.4800	0.360	0.56
6" EXTENSION SPIRAL POINT TAP	7	6H	3	21028		6.00	1.81	0.4800	0.360	0.56
TRU-FLO FORM TAP	14	6H		19230	19231	3.81	1.09	0.4800	0.360	0.56
TiN COAT / HAND TAP x 6" TAP	7	6H	4	55010		6.00	1.81	0.4800	0.360	0.56
+ .127mm HAND TAP	11	PLATING	4	20576	20577	3.81	1.81	0.4800	0.360	0.56
+ .127mm SPIRAL POINT TAP	11	PLATING	3	20574		3.81	1.81	0.4800	0.360	0.56
R.H. ROUND DIE 38.1mm OD				13576						
L.H. ROUND DIE 38.1mm OD				13577						
GAGE - Taperlock Style		6H		25103						
GAGE - Reversible Style		6H		25745						
GAGE - Ring-Go		6g		25300						
GAGE - Ring-NoGo		6g		25301						
<b>M16 X 1.5</b>						<i>Recommended Hole Size Based on 75% Thread = 14.5mm</i>				
HAND TAP	6	6H	4	20586	20587	3.81	1.81	0.4800	0.360	0.56
SPIRAL POINT TAP	6	6H	3	20584		3.81	1.81	0.4800	0.360	0.56
HAND TAP	3	4H	4	20581	20582	3.81	1.81	0.4800	0.360	0.56
SPIRAL POINT TAP	3	4H	3	20579		3.81	1.81	0.4800	0.360	0.56
L.H. HAND TAP	6	6H	4	20591	20592	3.81	1.81	0.4800	0.360	0.56
R.H. ROUND DIE 38.1mm OD				13578						
L.H. ROUND DIE 38.1mm OD				13579						
GAGE - Taperlock Style		6H		25108						
GAGE - Reversible Style		6H		25750						
GAGE - Ring-Go		6g		25305						
GAGE - Ring-NoGo		6g		25306						
<b>M16 X 1.0</b>						<i>Recommended Hole Size Based on 75% Thread = 15mm</i>				
HAND TAP	5	6H	4	21045	21046	3.81	1.81	0.4800	0.360	0.56
GAGE - Taperlock Style		6H		22976						
GAGE - Reversible Style		6H		22977						
GAGE - Ring-Go		6g		22978						
GAGE - Ring-NoGo		6g		22979						
<b>M18 X 2.5</b>						<i>Recommended Hole Size Based on 75% Thread = 15.5mm</i>				
HAND TAP	7	6H	4	20601	20602	4.03	1.81	0.5420	0.406	0.63
SPIRAL POINT TAP	7	6H	3	20599		4.03	1.81	0.5420	0.406	0.63
L.H. HAND TAP	7	6H	4	20606	20607	4.03	1.81	0.5420	0.406	0.63
R.H. ROUND DIE 38.1mm OD				13584						
L.H. ROUND DIE 38.1mm OD				13585						
GAGE - Taperlock Style		6H		25113						
GAGE - Reversible Style		6H		25755						
GAGE - Ring-Go		6g		25310						
GAGE - Ring-NoGo		6g		25311						
<b>M18 X 1.5</b>						<i>Recommended Hole Size Based on 75% Thread = 16.5mm TRU-FLO at 65% Thread = 17.34mm</i>				
HAND TAP	6	6H	4	20621	20622	4.03	1.81	0.5420	0.406	0.63
SPARK PL HAND TAP	4		4	20616	20617	4.03	1.81	0.5420	0.406	0.63



Click on Item Number below for Price List

SIZE/ DESCRIPTION	D#	CLASS OF FIT	# FLUTES	ITEM #		OVERALL LENGTH	THREAD LENGTH	SHANK DIAMETER	SQUARE DIAMETER	SQUARE LENGTH
				PLUG	BOTTOM					
<b>M18 X 1.5</b>						<i>See Previous Page for Recommended Hole Size</i>				
HAND TAP	3	4H	4	20611	20612	4.03	1.81	0.5420	0.406	0.63
L.H. HAND TAP	6	6H	4	20626	20627	4.03	1.81	0.5420	0.406	0.63
TRU-FLO FORM TAP	12	6H		19232	19233	4.03	1.09	0.5420	0.406	0.63
R.H. ROUND DIE 38.1mm OD				13586						
GAGE - Taperlock Style		6H		25118						
GAGE - Reversible Style		6H		25760						
GAGE - Ring-Go		6g		25315						
GAGE - Ring-NoGo		6g		25316						
<b>M18 X 1.0</b>						<i>Recommended Hole Size Based on 75% Thread = 17mm</i>				
HAND TAP	5	6H	4	20894	20895	4.03	1.81	0.5420	0.406	0.63
GAGE - Taperlock Style		6H		22988						
GAGE - Reversible Style		6H		22989						
GAGE - Ring-Go		6g		22990						
GAGE - Ring-NoGo		6g		22991						
<b>M20 X 2.5</b>						<i>Recommended Hole Size Based on 75% Thread = 17.5mm</i>				
HAND TAP	7	6H	4	20636	20637	4.47	2.00	0.6520	0.489	0.69
SPIRAL POINT TAP	7	6H	3	20634		4.47	2.00	0.6520	0.489	0.69
HAND TAP	4	4H	4	20631	20632	4.47	2.00	0.6520	0.489	0.69
FAST SPIRAL FLUTE TAP	7	6H	4	21051	21052	4.47	2.00	0.6520	0.489	0.69
L.H. HAND TAP	7	6H	4	20641	20642	4.47	2.00	0.6520	0.489	0.69
6" EXTENSION HAND TAP TAP	7	6H	4	20933	20934	6.00	2.00	0.6520	0.489	0.69
+.127mm HAND TAP	11	PLATING	4	20646	20647	4.47	2.00	0.6520	0.489	0.69
TiN COAT / SP PT TAP	7	6H	3	55005		4.47	2.00	0.6520	0.489	0.69
TiN COAT / HAND TAP	7	6H	4	55006		4.47	2.00	0.6520	0.489	0.69
R.H. ROUND DIE 50.8mm OD				13592						
L.H. ROUND DIE 50.8mm OD				13593						
GAGE - Taperlock Style		6H		25123						
GAGE - Ring-Go		6g		25320						
GAGE - Ring-NoGo		6g		25321						
<b>M20 X 1.5</b>						<i>Recommended Hole Size Based on 75% Thread = 18.5mm</i>				
HAND TAP	6	6H	4	20656	20657	4.47	2.00	0.6520	0.489	0.69
HAND TAP	3	4H	4	20651	20652	4.47	2.00	0.6520	0.489	0.69
L.H. HAND TAP	6	6H	4	20661	20662	4.47	2.00	0.6520	0.489	0.69
+.127mm HAND TAP	11	PLATING	4	20666	20667	4.47	2.00	0.6520	0.489	0.69
R.H. ROUND DIE 50.8mm OD				13594						
L.H. ROUND DIE 50.8mm OD				13595						
GAGE - Taperlock Style		6H		25128						
GAGE - Ring-Go		6g		25325						
GAGE - Ring-NoGo		6g		25326						
<b>M20 X 1.0</b>						<i>Recommended Hole Size Based on 75% Thread = 19mm</i>				
HAND TAP	6	6H	4	21048	21049	4.47	2.00	0.6520	0.489	0.69
GAGE - Taperlock Style		6H		21512						
GAGE - Ring-Go		6g		21513						
GAGE - Ring-NoGo		6g		21514						



TAPS, DIES & GAGES

Click on Item Number below for Price List

SIZE/ DESCRIPTION	D#	CLASS OF FIT	# FLUTES	ITEM #		OVERALL LENGTH	THREAD LENGTH	SHANK DIAMETER	SQUARE DIAMETER	SQUARE LENGTH
				PLUG	BOTTOM					
<b>M22 X 2.5</b>						<i>Recommended Hole Size Based on 75% Thread = 19.5mm</i>				
HAND TAP	7	6H	4	20676	20677	4.69	2.22	0.6970	0.523	0.75
HAND TAP	4	4H	4	20671	20672	4.69	2.22	0.6970	0.523	0.75
L.H. HAND TAP	7	6H	4	20681	20682	4.69	2.22	0.6970	0.523	0.75
R.H. ROUND DIE 50.8mm OD				13598						
GAGE - Taperlock Style		6H		25133						
GAGE - Ring-Go		6g		25330						
GAGE - Ring-NoGo		6g		25331						
<b>M22 X 1.5</b>						<i>Recommended Hole Size Based on 75% Thread = 20.5mm</i>				
HAND TAP	6	6H	4	20691	20692	4.69	2.22	0.6970	0.523	0.75
HAND TAP	3	4H	4	20686	20687	4.69	2.22	0.6970	0.523	0.75
L.H. HAND TAP	6	6H	4	20696	20697	4.69	2.22	0.6970	0.523	0.75
+.127mm HAND TAP	11	PLATING	4	20701	20702	4.69	2.22	0.6970	0.523	0.75
R.H. ROUND DIE 50.8mm OD				13600						
GAGE - Taperlock Style		6H		25138						
GAGE - Ring-Go		6g		25335						
GAGE - Ring-NoGo		6g		25336						
<b>M24 X 3.0</b>						<i>Recommended Hole Size Based on 75% Thread = 21mm</i>				
HAND TAP	8	6H	4	20711	20712	4.91	2.22	0.7600	0.570	0.75
SPIRAL POINT TAP	8	6H	3	21029		4.91	2.22	0.7600	0.570	0.75
HAND TAP	4	4H	4	20706	20707	4.91	2.22	0.7600	0.570	0.75
L.H. HAND TAP	8	6H	4	20716	20717	4.91	2.22	0.7600	0.570	0.75
+.127mm HAND TAP	11	PLATING	4	20721	20722	4.91	2.22	0.7600	0.570	0.75
TIN COAT / HAND TAP	8	6H	4	55007		4.91	2.22	0.7600	0.570	0.75
R.H. ROUND DIE 50.8mm OD				13604						
L.H. ROUND DIE 50.8mm OD				13605						
GAGE - Taperlock Style		6H		25143						
GAGE - Ring-Go		6g		25340						
GAGE - Ring-NoGo		6g		25341						
<b>M24 X 2.0</b>						<i>Recommended Hole Size Based on 75% Thread = 22mm</i>				
HAND TAP	7	6H	4	20731	20732	4.91	2.22	0.7600	0.570	0.75
HAND TAP	4	4H	4	20726	20727	4.91	2.22	0.7600	0.570	0.75
L.H. HAND TAP	7	6H	4	20736	20737	4.91	2.22	0.7600	0.570	0.75
R.H. ROUND DIE 50.8mm OD				13606						
L.H. ROUND DIE 50.8mm OD				13607						
GAGE - Taperlock Style		6H		25148						
GAGE - Ring-Go		6g		25345						
GAGE - Ring-NoGo		6g		25346						
<b>M24 X 1.5</b>						<i>Recommended Hole Size Based on 75% Thread = 22.5mm</i>				
HAND TAP	6	6H	4	20917	20918	4.91	2.22	0.7600	0.570	0.75
GAGE - Taperlock Style		6H		21545						
GAGE - Ring-Go		6g		21546						
GAGE - Ring-NoGo		6g		21547						
<b>M25 X 1.5</b>						<i>Recommended Hole Size Based on 75% Thread = 23.5mm</i>				
HAND TAP	6	6H	4	21031	21032	5.13	2.50	0.8000	0.600	0.81
GAGE - Taperlock Style		6H		21548						



Click on Item Number below for Price List

SIZE/ DESCRIPTION	D#	CLASS OF FIT	# FLUTES	ITEM #		OVERALL LENGTH	THREAD LENGTH	SHANK DIAMETER	SQUARE DIAMETER	SQUARE LENGTH
				PLUG	BOTTOM					
<b>M25 X 1.5</b>						<i>See Previous Page for Recommended Hole Size</i>				
GAGE - Ring-Go		6g		21549						
GAGE - Ring-NoGo		6g		21550						
<b>M26 X 1.5</b>						<i>Recommended Hole Size Based on 75% Thread = 24.5mm</i>				
<b>HAND TAP</b>	<b>6</b>	<b>6H</b>	<b>6</b>	<b>20981</b>	<b>20982</b>	<b>4.00</b>	<b>1.50</b>	<b>0.8960</b>	<b>0.672</b>	<b>0.88</b>
GAGE - Taperlock Style		6H		21557						
GAGE - Ring-Go		6g		21558						
GAGE - Ring-NoGo		6g		21559						
<b>M27 X 3.0</b>						<i>Recommended Hole Size Based on 75% Thread = 24mm</i>				
<b>HAND TAP</b>	<b>8</b>	<b>6H</b>	<b>4</b>	<b>20746</b>	<b>20747</b>	<b>5.13</b>	<b>2.50</b>	<b>0.8960</b>	<b>0.672</b>	<b>0.88</b>
<b>HAND TAP</b>	<b>5</b>	<b>4H</b>	<b>4</b>	<b>20741</b>	<b>20742</b>	<b>5.13</b>	<b>2.50</b>	<b>0.8960</b>	<b>0.672</b>	<b>0.88</b>
<b>L.H. HAND TAP</b>	<b>8</b>	<b>6H</b>	<b>4</b>	<b>20751</b>	<b>20752</b>	<b>5.13</b>	<b>2.50</b>	<b>0.8960</b>	<b>0.672</b>	<b>0.88</b>
R.H. ROUND DIE 63.5mm OD				13614						
GAGE - Taperlock Style		6H		25158						
GAGE - Ring-Go		6g		25350						
GAGE - Ring-NoGo		6g		25351						
<b>M27 X 2.0</b>						<i>Recommended Hole Size Based on 75% Thread = 25mm</i>				
<b>HAND TAP</b>	<b>7</b>	<b>6H</b>	<b>4</b>	<b>20761</b>	<b>20762</b>	<b>5.13</b>	<b>2.50</b>	<b>0.8960</b>	<b>0.672</b>	<b>0.88</b>
<b>HAND TAP</b>	<b>5</b>	<b>4H</b>	<b>4</b>	<b>20756</b>	<b>20757</b>	<b>5.13</b>	<b>2.50</b>	<b>0.8960</b>	<b>0.672</b>	<b>0.88</b>
R.H. ROUND DIE 63.5mm OD				13616						
GAGE - Taperlock Style		6H		25163						
GAGE - Ring-Go		6g		25355						
GAGE - Ring-NoGo		6g		25356						
<b>M27 X 1.5</b>						<i>Recommended Hole Size Based on 75% Thread = 25.5mm</i>				
<b>HAND TAP</b>	<b>6</b>	<b>6H</b>	<b>6</b>	<b>21057</b>	<b>21058</b>	<b>4.00</b>	<b>1.50</b>	<b>0.8960</b>	<b>0.672</b>	<b>0.88</b>
GAGE - Taperlock Style		6H		21578						
GAGE - Ring-Go		6g		21579						
GAGE - Ring-NoGo		6g		21580						
<b>M30 X 3.5</b>						<i>Recommended Hole Size Based on 75% Thread = 26.5mm</i>				
<b>HAND TAP</b>	<b>9</b>	<b>6H</b>	<b>4</b>	<b>20776</b>	<b>20777</b>	<b>5.44</b>	<b>2.56</b>	<b>1.0210</b>	<b>0.766</b>	<b>1.00</b>
<b>HAND TAP</b>	<b>5</b>	<b>4H</b>	<b>4</b>	<b>20771</b>	<b>20772</b>	<b>5.44</b>	<b>2.56</b>	<b>1.0210</b>	<b>0.766</b>	<b>1.00</b>
<b>L.H. HAND TAP</b>	<b>9</b>	<b>6H</b>	<b>4</b>	<b>20781</b>	<b>20782</b>	<b>5.44</b>	<b>2.56</b>	<b>1.0210</b>	<b>0.766</b>	<b>1.00</b>
R.H. ROUND DIE 63.5mm OD				13624						
L.H. ROUND DIE 63.5mm OD				13625						
GAGE - Taperlock Style		6H		25168						
GAGE - Ring-Go		6g		25360						
GAGE - Ring-NoGo		6g		25361						
<b>M30 X 2.0</b>						<i>Recommended Hole Size Based on 75% Thread = 26mm</i>				
<b>HAND TAP</b>	<b>7</b>	<b>6H</b>	<b>4</b>	<b>20791</b>	<b>20792</b>	<b>5.44</b>	<b>2.56</b>	<b>1.0210</b>	<b>0.766</b>	<b>1.00</b>
<b>HAND TAP</b>	<b>5</b>	<b>4H</b>	<b>4</b>	<b>20786</b>	<b>20787</b>	<b>5.44</b>	<b>2.56</b>	<b>1.0210</b>	<b>0.766</b>	<b>1.00</b>
R.H. ROUND DIE 63.5mm OD				13626						
GAGE - Taperlock Style		6H		25173						
GAGE - Ring-Go		6g		25365						
GAGE - Ring-NoGo		6g		25366						
<b>M30 X 1.5</b>						<i>Recommended Hole Size Based on 75% Thread = 28.5mm</i>				
<b>HAND TAP</b>	<b>6</b>	<b>6H</b>	<b>6</b>	<b>20898</b>	<b>20899</b>	<b>4.00</b>	<b>1.50</b>	<b>1.0210</b>	<b>0.766</b>	<b>1.00</b>

TAPS, DIES & GAGES

Click on Item Number below for Price List

SIZE/ DESCRIPTION	D#	CLASS OF FIT	# FLUTES	ITEM #		OVERALL LENGTH	THREAD LENGTH	SHANK DIAMETER	SQUARE DIAMETER	SQUARE LENGTH
				PLUG	BOTTOM					
<b>M30 X 1.5</b>						<i>See Previous Page for Recommended Hole Size</i>				
GAGE - Taperlock Style		6H		21593						
GAGE - Ring-Go		6g		21594						
GAGE - Ring-NoGo		6g		21595						
<b>M32 X 2.0</b>						<i>Recommended Hole Size Based on 75% Thread = 30mm</i>				
<b>HAND TAP</b>	<b>7</b>	<b>6H</b>	<b>6</b>	<b>21199</b>	<b>21200</b>	<b>5.75</b>	<b>2.56</b>	<b>1.0210</b>	<b>0.766</b>	<b>1.00</b>
GAGE - Taperlock Style		6H		21602						
GAGE - Ring-Go		6g		21603						
GAGE - Ring-NoGo		6g		21604						
<b>M32 X 1.5</b>						<i>Recommended Hole Size Based on 75% Thread = 30.5mm</i>				
<b>HAND TAP</b>	<b>6</b>	<b>6H</b>	<b>6</b>	<b>21060</b>	<b>21061</b>	<b>4.00</b>	<b>1.50</b>	<b>1.0210</b>	<b>0.766</b>	<b>1.00</b>
GAGE - Taperlock Style		6H		21611						
GAGE - Ring-Go		6g		21612						
GAGE - Ring-NoGo		6g		21613						
<b>M33 X 3.5</b>						<i>Recommended Hole Size Based on 75% Thread = 29.5mm</i>				
<b>HAND TAP</b>	<b>9</b>	<b>6H</b>	<b>4</b>	<b>20806</b>	<b>20807</b>	<b>5.75</b>	<b>2.56</b>	<b>1.1080</b>	<b>0.831</b>	<b>1.06</b>
<b>HAND TAP</b>	<b>5</b>	<b>4H</b>	<b>4</b>	<b>20801</b>	<b>20802</b>	<b>5.75</b>	<b>2.56</b>	<b>1.1080</b>	<b>0.831</b>	<b>1.06</b>
GAGE - Taperlock Style		6H		25178						
GAGE - Ring-Go		6g		25370						
GAGE - Ring-NoGo		6g		25371						
<b>M33 X 2.0</b>						<i>Recommended Hole Size Based on 75% Thread = 31mm</i>				
<b>HAND TAP</b>	<b>7</b>	<b>6H</b>	<b>4</b>	<b>20821</b>	<b>20822</b>	<b>5.75</b>	<b>2.56</b>	<b>1.1080</b>	<b>0.831</b>	<b>1.06</b>
<b>HAND TAP</b>	<b>5</b>	<b>4H</b>	<b>4</b>	<b>20816</b>	<b>20817</b>	<b>5.75</b>	<b>2.56</b>	<b>1.1080</b>	<b>0.831</b>	<b>1.06</b>
R.H. ROUND DIE 63.5mm OD				13634						
GAGE - Taperlock Style		6H		25183						
GAGE - Ring-Go		6g		25375						
GAGE - Ring-NoGo		6g		25376						
<b>M35 X 1.5</b>						<i>Recommended Hole Size Based on 75% Thread = 33.5mm</i>				
<b>HAND TAP</b>	<b>6</b>	<b>6H</b>	<b>6</b>	<b>20957</b>	<b>20958</b>	<b>4.00</b>	<b>1.50</b>	<b>1.1080</b>	<b>0.831</b>	<b>1.00</b>
GAGE - Taperlock Style		6H		21632						
GAGE - Ring-Go		6g		21633						
GAGE - Ring-NoGo		6g		21634						
<b>M36 X 4.0</b>						<i>Recommended Hole Size Based on 75% Thread = 32mm</i>				
<b>HAND TAP</b>	<b>9</b>	<b>6H</b>	<b>4</b>	<b>20836</b>	<b>20837</b>	<b>6.06</b>	<b>3.00</b>	<b>1.2330</b>	<b>0.925</b>	<b>1.13</b>
<b>HAND TAP</b>	<b>5</b>	<b>4H</b>	<b>4</b>	<b>20831</b>	<b>20832</b>	<b>6.06</b>	<b>3.00</b>	<b>1.2330</b>	<b>0.925</b>	<b>1.13</b>
R.H. ROUND DIE 63.5mm OD				13638						
GAGE - Taperlock Style		6H		25188						
GAGE - Ring-Go		6g		25380						
GAGE - Ring-NoGo		6g		25381						
<b>M36 X 3.0</b>						<i>Recommended Hole Size Based on 75% Thread = 33mm</i>				
<b>HAND TAP</b>	<b>8</b>	<b>6H</b>	<b>4</b>	<b>20851</b>	<b>20852</b>	<b>6.06</b>	<b>3.00</b>	<b>1.2330</b>	<b>0.925</b>	<b>1.13</b>
<b>HAND TAP</b>	<b>5</b>	<b>4H</b>	<b>4</b>	<b>20846</b>	<b>20847</b>	<b>6.06</b>	<b>3.00</b>	<b>1.2330</b>	<b>0.925</b>	<b>1.13</b>
R.H. ROUND DIE 63.5mm OD				13640						
GAGE - Taperlock Style		6H		25193						
GAGE - Ring-Go		6g		25385						
GAGE - Ring-NoGo		6g		25386						



Click on Item Number below for Price List

SIZE/ DESCRIPTION	D#	CLASS OF FIT	# FLUTES	ITEM #		OVERALL LENGTH	THREAD LENGTH	SHANK DIAMETER	SQUARE DIAMETER	SQUARE LENGTH
				PLUG	BOTTOM					
<b>M36 X 2.0</b>						<i>Recommended Hole Size Based on 75% Thread = 34mm</i>				
HAND TAP	7	6H	6	20921	20922	6.06	3.00	1.2330	0.925	1.13
GAGE - Taperlock Style		6H		21653						
GAGE - Ring-Go		6g		21654						
GAGE - Ring-NoGo		6g		21655						
<b>M36 X 1.5</b>						<i>Recommended Hole Size Based on 75% Thread = 34.5 mm</i>				
HAND TAP	6	6H	6	20961	20962	4.00	1.50	1.2330	0.925	1.00
GAGE - Taperlock Style		6H		21662						
GAGE - Ring-Go		6g		21663						
GAGE - Ring-NoGo		6g		21664						
<b>M39 X 4.0</b>						<i>Recommended Hole Size Based on 75% Thread = 35mm</i>				
HAND TAP	9	6H	6	20866	20867	6.69	3.19	1.3050	0.979	1.13
HAND TAP	6	4H	6	20861	20862	6.69	3.19	1.3050	0.979	1.13
GAGE - Tri-Lock Style		6H		25198						
GAGE - Ring-Go		6g		25390						
GAGE - Ring-NoGo		6g		25391						
<b>M39 X 3.0</b>						<i>Recommended Hole Size Based on 75% Thread = 36mm</i>				
HAND TAP	8	6H	6	20881	20882	6.69	3.19	1.3050	0.979	1.13
HAND TAP	6	4H	6	20876	20877	6.69	3.19	1.3050	0.979	1.13
R.H. ROUND DIE 76.2mm OD				13648						
GAGE - Tri-Lock Style		6H		25203						
GAGE - Ring-Go		6g		25395						
GAGE - Ring-NoGo		6g		25396						
<b>M40 X 1.5</b>						<i>Recommended Hole Size Based on 75% Thread = 38.5mm</i>				
HAND TAP	6	6H	6	20972	20973	5.00	2.00	1.3050	0.979	1.13
<b>M42 X 4.5</b>						<i>Recommended Hole Size Based on 75% Thread = 37.5mm</i>				
HAND TAP	10	6H	6	20965	20966	7.00	3.19	1.4300	1.072	1.25
<b>M42 X 1.5</b>						<i>Recommended Hole Size Based on 75% Thread = 40.5mm</i>				
HAND TAP	6	6H	6	21063	21064	5.00	2.00	1.4300	1.072	1.25

- The recommended hole sizes shown are reference values, and depending on specific tapping requirements and conditions, may have to be altered. North American Tool Corporation assumes no responsibility or liability of any kind as a result of the selection of tap hole sizes from this catalog.
- Dimensions shown for metric taps are decimal inch values, and are not metric (mm) values.
- Note: For Unified, Metric and Pipe EXTENSION taps, S.T.I. tap and gage sizes, or SPECIAL taps NOT LISTED, please contact our Customer Service Dept.
- FOR QUESTIONS, PLEASE CONTACT OUR CUSTOMER SERVICE DEPT.

# APPLICATION SPECIFIC BLUEPRINT SPECIAL TAPS

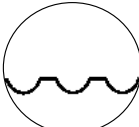
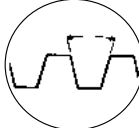
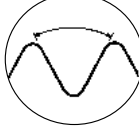
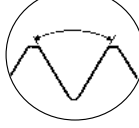



## High Performance Blueprint Special Taps - Shipped Fast!

North American Tool Corporation continues a commitment to quality and service by offering you a complete line of blueprint special taps - shipped fast! Our experienced team of cutting tool specialists will provide design expertise or work from your blueprint specifications to manufacture reliable special taps that meet your exact specifications, in as few as seven days, depending on the specialty of design and quantity ordered.

Our bar steel is available in a broad range of grades and diameters, and is made of top quality High Speed Steel, or material specified to best fit the threading application at hand. The majority of special taps can be produced from a standard design hardened blank. Our dedication to quality, rapid shipments and customer service has made North American Tool Corporation the most respected producer of special taps, dies and gages.



**SPECIAL THREAD FORMS**

-  **BALL SCREW (GOTHIC ARCH)**
-  **ACME, STUB ACME**
-  **FULL FORM RADIUS**
-  **RADIUS ROOT**
-  **SPECIAL ANGLES**
-  **BUTTRESS**
-  **VARYING CHAMFER ANGLES**



## APPLICATION SPECIFIC BLUEPRINT SPECIAL TAPS

### Made-To-Order Blueprint Special Taps

Following are a few of the special features requiring taps be custom manufactured from bar steel, such as...

- Special Overall Lengths either in shank, thread length, or piloted;
- Special Shank and Drive dimensions: Morse taper shanks, threaded, whistle-notch;
- Special Flute Design - straight or spiral;
- Holes - drilled, reamed, ground, cross, coolant-hole, through-hole;
- Flats - notches, keyways, necks;
- Tapered thread, including pipe taps;
- Tandem style;
- Combination tools, to eliminate secondary or finishing operations;
- Reamer point / Drill point / Core Drill;
- Special Forms & Angles - Acme buttress, square thread, full form, modified Whitworth form, custom thread form;
- Special steels available, in combination with numerous surface treatment possibilities, depending on the application at hand.



**TURNAROUND  
IN AS FEW AS  
7 DAYS!**





## FEATURED PRODUCTS

# CARBIDE TAPS AND CARB-I-SERT TAPS

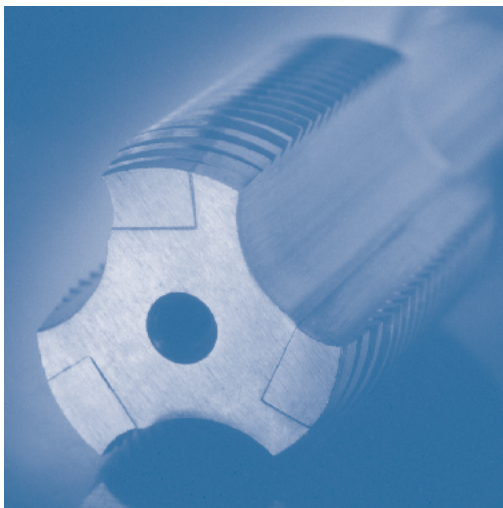
### Why North American Tool Carbide Taps?

- Special design criteria (unique characteristics and geometry) can be incorporated to allow unmatched efficiencies in tough materials such as titanium, beryllium, ceramics, plastics, fiberglass, resins, stellite, inconel, and more
- Solid carbide and Carb-I-Sert™ taps are available in a wide range of sizes, in both inch and metric measurements, and available in either straight and taper pipe threads.
- Experienced engineers, state-of-the-art equipment and production processes, advanced computer systems and machining equipment provide value-added solutions to your challenging tapping requirements.
- Cutting tools designed, manufactured, and shipped in the U.S.A.

- 60° Thread Forms
- Pipe Threads
- Form Taps
- S.T.I. Taps
- Specials Available Upon Request

North American Tool carbide taps are available from stock in popular sizes.

See next page for complete listing.





**SOLID CARBIDE TAPS**

To Table 302-A Includes Pipe Sizes

SIZE	H LIMIT	# OF FLUTES	ITEM# PLUG	ITEM# BOTTOM
#0-80	H2	2	41579	41580
#2-56	H2	2	41536	41537
#2-56 SPPT	H2	2	41538	
#4-40	H2	2	41007	41008
#4-40 SPPT	H2	2	41009	
#4-48	H2	2	41017	41018
#4-48 SPPT	H2	2	41019	
#5-40	H2	3	41034	41035
#5-40 SPPT	H2	2	41032	
#6-32	H3	3	41074	41075
#6-32 SPPT	H3	2	41072	
#6-40	H2	3	41092	41093
#8-32	H3	4	41125	41126
#8-32 SPPT	H3	2	41120	
#8-36	H2	4	41147	41148
#10-24	H3	4	41180	41181
#10-24 SPPT	H3	2	41175	
#10-32	H3	4	41213	41214
#10-32 SPPT	H3	2	41208	
#12-24	H3	4	41246	41247
#12-24 SPPT	H3	2	41241	
#12-28	H3	4	41279	41280
#12-28 SPPT	H3	2	41274	
1/16-27 NPT/F		4	41800	
1/8-27 NPT		4	41801	
1/8-27 NPSF		4	41807	
1/4-18 NPT		4	41802	
1/4-20	H3	4	41312	41313
1/4-20 SPPT	H3	2	41307	
1/4-28	H3	4	41345	41346
1/4-28 SPPT	H3	2	41340	
5/16-18	H3	4	41378	41379
5/16-18 SPPT	H3	2	41373	
5/16-24	H3	4	41411	41412
3/8-16	H3	4	41444	41445
3/8-16 SPPT	H3	3	41442	
3/8-24	H3	4	41476	41477
7/16-14	H3	4	41520	41521
7/16-14 SPPT	H3	3	41522	
7/16-20	H3	4	41524	41525
7/16-20 SPPT	H3	3	41526	
1/2-13	H3	4	41528	41529
1/2-13 SPPT	H3	3	41530	
1/2-20	H3	4	41532	41533
1/2-20 SPPT	H3	3	41534	
9/16-12 NC	H3	4	47201	47202
9/16-18 NF	H3	4	47204	47205
5/8-11 NC	H3	4	47207	47208
5/8-18 NF	H3	4	47210	47211
3/4-10 NC	H3	4	47213	47214
3/4-10 NC	H5	4	47228	47229
3/4-16 NF	H3	4	47216	47217
3/4-16 NF	H5	4	47231	47232

**SOLID CARBIDE TAPS - METRIC**

To Table 302-A

SIZE	H LIMIT	# OF FLUTES	ITEM# PLUG	ITEM# BOTTOM
M3 x 0.5	D3	3	43001	43002
M3 x 0.5 SPPT	D3	2	43003	
M3.5 x 0.6	D4	3	43005	43006
M3.5 x 0.6 SPPT	D4	2	43007	
M4 x 0.7	D4	4	43009	43010
M4 x 0.7 SPPT	D4	2	43011	
M4.5 x 0.75	D4	4	43013	43014
M4.5 x 0.75 SPPT	D4	2	43015	
M5 x 0.8	D4	4	43017	43018
M5 x 0.8 SPPT	D4	2	43019	
M6 x 1.0	D5	4	43021	43022
M6 x 1.0 SPPT	D5	2	43023	
M7 x 1.0	D5	4	43025	43026
M7 x 1.0 SPPT	D5	2	43027	
M8 x 1.25	D5	4	43029	43030
M8 x 1.25 SPPT	D5	2	43031	
M8 x 1.0	D5	4	43033	43034
M10 x 1.5	D6	4	43037	43038
M10 x 1.5 SPPT	D6	3	43039	43046
M12 x 1.75	D6	4	43045	
M12 x 1.75 SPPT	D6	3	43047	

**CARB-I-SERT™ CARBIDE INSERT TAPS**

Includes Pipe Sizes

SIZE	H LIMIT	# OF FLUTES	ITEM# PLUG	ITEM# BOTTOM
3/8-18 NPT/F		4	41808	
1/12-14 NPT/F		4	41809	
3/4-14 NPT/F		4	41810	
7/8-9	H4	4	41558	41559
7/8-14	H4	4	41561	41562
1"-8	H4	4	41564	41565
1"-11-1/2 NPT/F		6	41811	
1"-12	H4	4	41567	41568
1-1/4-7	H4	4	41570	41571
1-3/8-12	H4	4	41573	41574
1-1/2-6	H4	4	41576	41577

## CARBIDE, HSS AND HSSE THREAD MILLS

## Why North American Tool Thread Mills?



These thread mills are designed to produce internal and external threads utilizing helical milling to produce the desired thread profile. Thread mills are typically smaller in diameter than their corresponding tap would be, thus enabling them to fit within the ID of the pre-drilled hole. CNC machines with 3-axis capability are required to use thread mills.

North American Tool's carbide, HSS and HSSE thread mills provide a cleaner cut and an exceptional finish to extend tool life. Our mills are available in standard and customized designs.

- Manufactured from micro-grain carbide, high speed steel or premium high speed steel; surface treatments are available for maximum tool life and cutting speeds.
- Thread different hole diameters with one tool.
- Straight and helical flute designs available; helical flute allows smoother, cleaner cuts and extended tool life.
- Technical support available.
- Exceptional thread finish on a wide range of materials, including tough, exotic materials.



SMART CUT TAPPING & DRILLING FLUID

# SMART CUT

HIGH PERFORMANCE METAL WORKING FLUID FOR TAPPING & DRILLING



- Maximum accuracy in machined parts.
- Increases productivity.
- Extends life of the tap.
- Excellent friction-reducing properties.
- Can be used for many machining applications including drilling and sawing.

## Why 'Smart Cut™' Tapping And Cutting Fluid From North American Tool?

- Environmentally SMART...ozone friendly.
- Contains no carbon tetrachloride or 1,1,1-Trichloroethane.
- Designed to extend tool life.
- Penetrates to the tool's cutting edge and stays on the tool.
- Eliminates the hassles of costly hazardous waste disposal.
- Smart Cut is thick, won't evaporate and stays on the tool throughout the cutting operation.
- Does not contain any animal-derived components or components synthesized from animal-derived materials.



### SMART CUT TAPPING FLUID

PART NUMBER	DESCRIPTION	SIZE
FL110	Smart Cut	16 oz.
FL115	Smart Cut	16 oz. (12/case)
FL120	Smart Cut	1 gallon
FL125	Smart Cut	1 gallon (4/case)
FL130	Smart Cut	5 gallon
FL135	Smart Cut	55 gallon drum

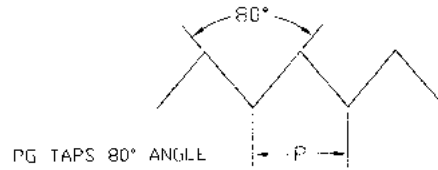
Click on Part Number above for Price List

PRODUCT SPECIFICATIONS

SPECIAL TAPS

CONDUIT THREAD TAPS

PER DIN STD. #40430 • 80° INCLUDED ANGLE • 'PG' SERIES TO TABLES 302/303



TYPE	SIZE	# FLUTES	ITEM #		OVERALL LENGTH	THREAD LENGTH	SHANK DIAMETER	SQUARE DIAMETER	SQUARE LENGTH
			PLUG	BOTTOM					
PG 7	M12.5 X 1.27	4	20992	20993	3.38	1.66	0.3670	0.275	0.44
PG 9	M15.2 X 1.41	4	20995	20996	3.81	1.81	0.4800	0.360	0.56
PG 11	M18.6 X 1.41	4	20998	20999	4.25	2.00	0.5900	0.442	0.69
PG 13.5	M20.4 X 1.41	4	21001	21002	4.47	2.00	0.6520	0.489	0.69
PG 16	M22.5 X 1.41	4	21004	21005	4.69	2.22	0.6970	0.523	0.75
PG 21	M28.3 X 1.588	6	21007	21008	4.00	1.50	0.8960	0.672	0.88
PG 29	M37 X 1.588	6	21010	21011	4.00	1.50	1.2330	0.925	1.00
PG 36	M47 X 1.588	6	21013	21014	5.00	2.00	1.5190	1.139	1.25
PG 42	M54 X 1.588	6	21016	21017	5.25	2.00	1.7690	1.327	1.38
PG 48	M59.3 X 1.588	6	21019	21020	5.25	2.00	2.0190	1.514	1.44



H.S.S. SPECIAL SPIRAL FLUTE TAPS

PLUG & BOTTOM STYLE - INCLUDING METRIC SIZES TO TABLE 302

SIZE	MAX TPI	SIZE MM	MIN. PITCH MM	OVERALL LENGTH	THREAD LENGTH	SHANK DIAMETER	SQUARE DIAMETER	SQUARE LENGTH
#2	100	M2.0, M2.2	0.3	1.81	0.50	0.1410	0.110	0.19
#3	100	M2.3, M2.5, M2.6	0.3	1.81	0.50	0.1410	0.110	0.19
#4	100			1.88	0.56	0.1410	0.110	0.19
#5	100	M3	0.3	1.94	0.63	0.1410	0.110	0.19
#6	100	M3.5	0.3	2.00	0.69	0.1410	0.110	0.25
#8	100	M4	0.3	2.13	0.75	0.1680	0.131	0.25
#10	100	M4.5, M5	0.3	2.38	0.88	0.1940	0.152	0.25
#12	100	M5.5	0.3	2.38	0.94	0.2200	0.165	0.28
#14	80	M6	0.3	2.50	1.00	0.2550	0.191	0.31
1/4"	80	M6	0.3	2.50	1.00	0.2550	0.191	0.31
5/16"	80	M7, M8	0.3	2.72	1.13	0.3180	0.238	0.38
3/8"	80	M9, M10	0.3	2.94	1.25	0.3810	0.286	0.44
7/16"	80	M11	0.3	3.16	1.44	0.3230	0.242	0.41
1/2"	80	M12	0.3	3.38	1.66	0.3670	0.275	0.44
9/16"	64	M14	0.4	3.59	1.66	0.4290	0.322	0.50
5/8"	64	M16	0.4	3.81	1.81	0.4800	0.360	0.56
11/16"	64	M18	0.4	4.03	1.81	0.5420	0.406	0.63
3/4"	64		0.4	4.25	2.00	0.5900	0.442	0.69
13/16"	64	M20		4.47	2.00	0.6520	0.489	0.69
7/8"	64	M22	0.4	4.69	2.22	0.6970	0.523	0.75
15/16"	64	M24		4.91	2.22	0.7600	0.570	0.75
1"	64	M25		5.13	2.50	0.8000	0.600	0.81

These taps are available in left hand style, and in a variety of helix angles including low, medium and high spiral.





**H.S.S. SPECIAL HAND TAPS**

RIGHT AND LEFT HAND INCLUDING METRIC SIZES TO TABLE 302

MAX SIZE	SIZE	MAX TPI	SIZE MM	MIN. PITCH MM	OVERALL LENGTH	THREAD LENGTH	SHANK DIAMETER	SQUARE DIAMETER	SQUARE LENGTH
0.047	#00	120	M1.0	0.2	1.63	0.31	0.1410	0.110	0.19
0.065	#0	100	M1.5, M1.6	0.3	1.63	0.31	0.1410	0.110	0.19
0.078	#1	100	M1.8	0.3	1.69	0.38	0.1410	0.110	0.19
0.091	#2	100	M2, M2.2	0.3	1.75	0.44	0.1410	0.110	0.19
0.104	#3	100	M2.3, M2.5, M2.6	0.3	1.81	0.50	0.1410	0.110	0.19
0.117	#4	100			1.88	0.56	0.1410	0.110	0.19
0.13	#5	100	M3	0.3	1.94	0.63	0.1410	0.110	0.19
0.145	#6	100	M3.5	0.3	2.00	0.69	0.1410	0.110	0.25
0.171	#8	100	M4	0.3	2.13	0.75	0.1680	0.131	0.25
0.197	#10	100	M4.5, M5	0.3	2.38	0.88	0.1940	0.152	0.25
0.223	#12	100	M5.5	0.3	2.38	0.94	0.2200	0.165	0.28
0.26	#14	80	M6	0.3	2.50	1.00	0.2550	0.191	0.31
0.26	1/4"	80	M6	0.3	2.50	1.00	0.2550	0.191	0.31
0.323	5/16"	80	M7, M8	0.3	2.72	1.13	0.3180	0.238	0.38
0.385	3/8"	80	M9, M10	0.3	2.94	1.25	0.3810	0.286	0.44
0.448	7/16"	80	M11	0.3	3.16	1.44	0.3230	0.242	0.41
0.51	1/2"	80	M12	0.3	3.38	1.66	0.3670	0.275	0.44
0.573	9/16"	64	M14	0.4	3.59	1.66	0.4290	0.322	0.50
0.635	5/8"	64	M16	0.4	3.81	1.81	0.4800	0.360	0.56
0.709	11/16"	64	M18	0.4	4.03	1.81	0.5420	0.406	0.63
0.76	3/4"	64			4.25	2.00	0.5900	0.442	0.69
0.823	13/16"	64	M20	0.4	4.47	2.00	0.6520	0.489	0.69
0.885	7/8"	64	M22	0.4	4.69	2.22	0.6970	0.523	0.75
0.948	15/16"	64	M24	0.4	4.91	2.22	0.7600	0.570	0.75
1.01	1"	64	M25	0.4	5.13	2.50	0.8000	0.600	0.81

**H.S.S. SPECIAL HAND TAPS**

RIGHT AND LEFT HAND INCLUDING METRIC SIZES TO TABLES 302-303

SIZE	MAX TPI	SIZE MM	MIN. PITCH MM	OVERALL LENGTH	THREAD LENGTH	SHANK DIAMETER	SQUARE DIAMETER	SQUARE LENGTH	TAP DIMEN. TABLE	# OF FLUTES
1 1/16"	13	M27	2	5.13	2.50	0.8960	0.672	0.88	302	4-6
1 1/16"	55	M27	0.5	4.00	1.50	0.8960	0.672	0.88	303	6-8-10
1 1/8"	13	M28	2	5.44	2.56	0.8960	0.672	0.88	302	4-6
1 1/8"	55	M28	0.5	4.00	1.50	0.8960	0.672	0.88	303	6-8-10
1 3/16"	13	M30	2	5.44	2.56	1.0210	0.766	1.00	302	4-6
1 3/16"	55	M30	0.5	4.00	1.50	1.0210	0.766	1.00	303	6-8-10
1 1/4"	13	M32	2	5.75	2.56	1.0210	0.766	1.00	302	4-6
1 1/4"	55	M32	0.5	4.00	1.50	1.0210	0.766	1.00	303	6-8-10
1 5/16"	13	M33	2	5.75	2.56	1.1080	0.831	1.06	302	4-6
1 5/16"	55	M33	0.5	4.00	1.50	1.1080	0.831	1.00	303	6-8-10
1 3/8"	13	M35	2	6.06	3.00	1.1080	0.831	1.06	302	4-6
1 3/8"	55	M35	0.5	4.00	1.50	1.1080	0.831	1.00	303	6-8-10
1 7/16"	13	M36	2	6.06	3.00	1.2330	0.925	1.13	302	4-6

(cont. on next page)





SPECIAL TAPS



H.S.S. SPECIAL HAND TAPS

RIGHT AND LEFT HAND INCLUDING METRIC SIZES TO TABLES 302-303

SIZE	MAX TPI	SIZE MM	MIN. PITCH MM	OVERALL LENGTH	THREAD LENGTH	SHANK DIAMETER	SQUARE DIAMETER	SQUARE LENGTH	TAP DIMEN. TABLE	# OF FLUTES
1 7/16"	55	M36	0.5	4.00	1.50	1.2330	0.925	1.00	303	6-8-10
1 1/2"	13	M38	2	6.38	3.00	1.2330	0.925	1.13	302	4-6
1 1/2"	55	M38	0.5	4.00	1.50	1.2330	0.925	1.00	303	6-8-10
1 5/8"	9	M39	3	6.69	3.19	1.3050	0.979	1.13	302	6
1 5/8"	55	M39	0.5	5.00	2.00	1.3050	0.979	1.13	303	6-8-10
1 3/4"	9	M42	3	7.00	3.19	1.4300	1.072	1.25	302	6
1 3/4"	55	M42	0.5	5.00	2.00	1.4300	1.072	1.25	303	6-8-10
1 7/8"	9	M45	3	7.31	3.56	1.5190	1.139	1.25	302	6
1 7/8"	55	M45	0.5	5.00	2.00	1.5190	1.139	1.25	303	6-8-10
2"	9	M48	3	7.63	3.56	1.6440	1.233	1.38	302	6
2"	47	M48	0.5	5.00	2.00	1.6440	1.233	1.38	303	6-8-10
2 1/8"	9	M54	3	8.00	3.56	1.7690	1.327	1.38	302	6
2 1/8"	47	M54	0.5	5.25	2.00	1.7690	1.327	1.38	303	6
2 1/4"	9	M56	3	8.25	3.56	1.8940	1.420	1.44	302	6
2 1/4"	47	M56	0.5	5.25	2.00	1.8940	1.420	1.44	303	6
2 3/8"	9	M60	3	8.50	4.00	2.0190	1.514	1.44	302	6
2 3/8"	47	M60	0.5	5.25	2.00	2.0190	1.514	1.44	303	6
2 1/2"	9	M63	3	8.75	4.00	2.1000	1.575	1.50	302	6
2 1/2"	47	M63	0.5	5.25	2.00	2.1000	1.575	1.50	303	6
2 5/8"	9	M64	3	8.75	4.00	2.2250	1.669	1.50	302	6
2 5/8"	47	M64	0.5	5.50	2.00	2.1000	1.575	1.50	303	6
2 3/4"	9	M70	3	9.25	4.00	2.3500	1.762	1.56	302	6
2 3/4"	47	M70	0.5	5.50	2.00	2.1000	1.575	1.50	303	6
2 7/8"	9	M72	3	9.25	4.00	2.4750	1.856	1.56	302	6
2 7/8"	47	M72	0.5	5.50	2.00	2.1000	1.575	1.50	303	6
3"	9	M76	3	9.75	4.56	2.5430	1.907	1.63	302	6
3"	47	M76	0.5	5.50	2.00	2.1000	1.575	1.50	303	8
3 1/8"	9	M79	3	9.75	4.56	2.6680	2.001	1.63	302	6
3 1/8"	35	M79	0.7	5.75	2.00	2.1000	1.575	1.50	303	8
3 1/4"	9	M82	3	10.00	4.56	2.7930	2.095	1.75	302	6
3 1/4"	35	M82	0.7	5.75	2.00	2.1000	1.575	1.50	303	6-8
3 1/2"	9	M89	3	10.25	4.94	3.0080	2.256	2.00	302	6
3 1/2"	35	M89	0.7	5.75	2.00	2.1000	1.575	1.50	303	6-8
3 5/8"	9	M92	3	10.25	4.94	3.1330	2.350	2.00	302	8
3 5/8"	35	M92	0.7	6.00	2.00	2.1000	1.575	1.75	303	8
3 3/4"	9	M95	3	10.50	5.31	3.2170	2.413	2.13	302	10
3 3/4"	35	M95	0.7	6.00	2.00	2.1000	1.575	1.75	303	10
3 7/8"	9	M98	3	10.50	5.31	3.3420	2.506	2.13	302	10
3 7/8"	35	M98	0.7	6.00	2.00	2.1000	1.575	1.75	303	10
4"	9	M101	3	10.75	5.31	3.4670	2.600	2.25	302	10
4"	35	M101	0.7	6.00	2.00	2.1000	1.575	1.75	303	10

- Table 302 = Long series blank
- Table 303 = Short series blank
- 303 blanks 1-1/16" through 4", number of flutes used will depend on TPI

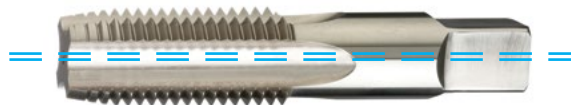




**TRU-FLO® THREAD FORMING TAPS**  
TO TABLE 302-A

SIZE	SIZE MM	OVERALL LENGTH	THREAD LENGTH	SHANK DIAMETER	SQUARE DIAMETER	SQUARE LENGTH	NECK LENGTH
#0	M1.5, M1.6	1.63	0.31	0.1410	0.110	0.19	
#1	M1.8	1.69	0.38	0.1410	0.110	0.19	
#2	M2, M2.2	1.75	0.44	0.1410	0.110	0.19	
#3	M2.3, M2.5, M2.6	1.81	0.50	0.1410	0.110	0.19	
#4		1.88	0.31	0.1410	0.110	0.19	0.25
#5	M3	1.94	0.31	0.1410	0.110	0.19	0.31
#6	M3.5	2.00	0.38	0.1410	0.110	0.19	0.31
#8	M4	2.13	0.38	0.1680	0.131	0.25	0.38
#10	M4.5, M5	2.38	0.50	0.1940	0.152	0.25	0.38
#12	M5.5	2.38	0.50	0.2200	0.165	0.28	0.44
1/4"	M6	2.50	0.63	0.2550	0.191	0.31	0.38
5/16"	M7, M8	2.72	0.69	0.3180	0.238	0.38	0.44
3/8"	M9, M10	2.94	0.75	0.3810	0.286	0.44	0.50
7/16"	M11	3.16	0.88	0.3230	0.242	0.41	
1/2"	M12	3.38	0.94	0.3670	0.275	0.44	
9/16"	M14	3.59	1.00	0.4290	0.322	0.50	
5/8"	M16	3.81	1.09	0.4800	0.360	0.56	
11/16"	M18	4.03	1.09	0.5420	0.406	0.63	
3/4"		4.25	1.22	0.5900	0.442	0.69	
13/16"	M20	4.47	1.22	0.6520	0.489	0.69	
7/8"	M22	4.69	1.34	0.6970	0.523	0.75	
15/16"	M24	4.91	1.34	0.7600	0.570	0.75	
1"	M25	5.13	1.50	0.8000	0.600	0.81	

Multiple leads, special chamfer, and spiral lobes are available. Thread forming taps are also available in solid carbide.



**COOLANT THROUGH TAPS**  
TO TABLE 302-A

SIZE	SIZE MM	MAX TPI	OVERALL LENGTH	THREAD LENGTH	SHANK DIAMETER	SQUARE DIAMETER	SQUARE LENGTH	NECK LENGTH
1/4"	M6	80	2.50	0.63	0.2550	0.191	0.31	0.38
5/16"	M8	80	2.72	0.69	0.3180	0.238	0.38	0.44
3/8"	M10	80	2.94	0.75	0.3810	0.286	0.44	0.50
7/16"	M11	80	3.16	0.88	0.3230	0.242	0.41	
1/2"	M12	80	3.38	0.94	0.3670	0.275	0.44	
9/16"	M14	64	3.59	1.00	0.4290	0.322	0.50	
5/8"	M16	64	3.81	1.09	0.4800	0.360	0.56	
3/4"		64	4.25	1.22	0.5900	0.442	0.69	
7/8"	M22	64	4.69	1.34	0.6970	0.523	0.75	
1"	M25	64	5.13	1.50	0.8000	0.600	0.81	



SPECIAL TAPS



**H.S.S. SPECIAL PIPE TAPS - NPS, NPT & BSPP, BSPT**

RIGHT AND LEFT HAND • FULL OR INTERRUPTED THREAD TO TABLE 311

NPS NPT PIPE SIZE	BSPP BSPT PIPE SIZE	EQUIV. HAND TAP SIZE	MIN. PROJECTION	# OF FLUTES	FULL OR NPT INT. THD.	OVERALL LENGTH	THREAD LENGTH	SHANK DIAMETER	SQUARE DIAMETER	SQUARE LENGTH	NECK LENGTH
1/16"-27	1/16"-28	5/16"	0.06	4	NPS FULL THD	2.13	0.69	0.3125	0.234	0.38	0.38
1/16"-27	1/16"-28	5/16"	0.06	4	NPT FULL THD	2.13	0.69	0.3125	0.234	0.38	0.38
1/16"-27	1/16"-28	5/16"	0.06	5	NPT INT THD	2.13	0.69	0.3125	0.234	0.38	0.38
1/8"-27	1/8"-28	7/16"	0.06	4	NPS FULL THD	2.13	0.75	0.4375	0.328	0.38	0.38
1/8"-27	1/8"-28	7/16"	0.06	4	NPT FULL THD	2.13	0.75	0.4375	0.328	0.38	0.38
1/8"-27	1/8"-28	7/16"	0.06	5	NPT INT THD	2.13	0.75	0.4375	0.328	0.38	0.38
1/4"-18	1/4"-19	9/16"	0.12	4	NPS FULL THD	2.44	1.06	0.5625	0.421	0.44	0.38
1/4"-18	1/4"-19	9/16"	0.12	4	NPT FULL THD	2.44	1.06	0.5625	0.421	0.44	0.38
1/4"-18	1/4"-19	9/16"	0.12	5	NPT INT THD	2.44	1.06	0.5625	0.421	0.44	0.38
3/8"-18	3/8"-19	11/16"	0.14	4	NPS FULL THD	2.56	1.06	0.7000	0.531	0.50	0.38
3/8"-18	3/8"-19	11/16"	0.14	4	NPT FULL THD	2.56	1.06	0.7000	0.531	0.50	0.38
3/8"-18	3/8"-19	11/16"	0.14	5	NPT INT THD	2.56	1.06	0.7000	0.531	0.50	0.38
1/2"-14	1/2"-14	7/8"	0.26	4	NPS FULL THD	3.13	1.38	0.6875	0.515	0.63	
1/2"-14	1/2"-14	7/8"	0.26	4	NPT FULL THD	3.13	1.38	0.6875	0.515	0.63	
1/2"-14	1/2"-14	7/8"	0.26	5	NPT INT THD	3.13	1.38	0.6875	0.515	0.63	
3/4"-14	3/4"-14	1 1/16"	0.245	5	NPS FULL THD	3.25	1.38	0.9063	0.679	0.69	
3/4"-14	3/4"-14	1 1/16"	0.245	5	NPT FULL THD	3.25	1.38	0.9063	0.679	0.69	
3/4"-14	3/4"-14	1 1/16"	0.245	5	NPT INT THD	3.25	1.38	0.9063	0.679	0.69	
1"-11.5	1"-11	1 5/16"	0.36	5	NPS FULL THD	3.75	1.75	1.1250	0.843	0.81	
1"-11.5	1"-11	1 5/16"	0.36	5	NPT FULL THD	3.75	1.75	1.1250	0.843	0.81	
1"-11.5	1"-11	1 5/16"	0.36	5	NPT INT THD	3.75	1.75	1.1250	0.843	0.81	
1 1/4"-11.5	1 1/4"-11	1 11/16"	0.37	5	NPS FULL THD	4.00	1.75	1.3125	0.984	0.94	
1 1/4"-11.5	1 1/4"-11	1 11/16"	0.37	5	NPT FULL THD	4.00	1.75	1.3125	0.984	0.94	
1 1/4"-11.5	1 1/4"-11	1 11/16"	0.37	5	NPT INT THD	4.00	1.75	1.3125	0.984	0.94	
1 1/2"-11.5	1 1/2"-11	2"	0.38	7	NPS FULL THD	4.25	1.75	1.5000	1.125	1.00	
1 1/2"-11.5	1 1/2"-11	2"	0.38	7	NPT FULL THD	4.25	1.75	1.5000	1.125	1.00	
1 1/2"-11.5	1 1/2"-11	2"	0.38	7	NPT INT THD	4.25	1.75	1.5000	1.125	1.00	
2"-11.5	2"-11	2 1/2"	0.38	7	NPS FULL THD	4.25	1.75	1.8750	1.406	1.13	
2"-11.5	2"-11	2 1/2"	0.38	7	NPT FULL THD	4.25	1.75	1.8750	1.406	1.13	
2"-11.5	2"-11	2 1/2"	0.38	7	NPT INT THD	4.25	1.75	1.8750	1.406	1.13	
2 1/2"-8	2 1/2"-11	3"	0.525	7	NPS FULL THD	5.50	2.56	2.2500	1.687	1.25	
2 1/2"-8	2 1/2"-11	3"	0.525	7	NPT FULL THD	5.50	2.56	2.2500	1.687	1.25	
2 1/2"-8	2 1/2"-11	3"	0.525	7	NPT INT THD	5.50	2.56	2.2500	1.687	1.25	

• **BRITISH STRAIGHT PIPE (BSP)**

Also referred to as British Gas, British Pipe Parallel or Parallel Fastening Thread. Various Symbols: BSP, BSPP, BSPPI, BSPF, BSPG, PS, R,G, RP

• **BRITISH TAPER PIPE (BSPT)**

Also referred to as British Standard Taper Pipe, or Pipe Taper, or Conical Thread. Various Symbols: BSPT, BSPT<sub>r</sub>, PT, KR, Rc.





**H.S.S. SPECIAL ACME HAND TAPS**

TO TABLE 302

SIZE	OVERALL LENGTH	THREAD LENGTH	SHANK DIAMETER	SQUARE DIAMETER	SQUARE LENGTH
1/4"	2.50	1.00	0.2550	0.191	0.31
5/16"	2.72	1.13	0.3180	0.238	0.38
3/8"	2.94	1.25	0.3810	0.286	0.44
7/16"	3.16	1.44	0.3230	0.242	0.41
1/2"	3.38	1.66	0.3670	0.275	0.44
9/16"	3.59	1.66	0.4290	0.322	0.50
5/8"	3.81	1.81	0.4800	0.360	0.56
11/16"	4.03	1.81	0.5420	0.406	0.63
3/4"	4.25	2.00	0.5900	0.442	0.69
13/16"	4.47	2.00	0.6520	0.489	0.69
7/8"	4.69	2.22	0.6970	0.523	0.75
15/16"	4.91	2.22	0.7600	0.570	0.75
1"	5.13	2.50	0.8000	0.600	0.81
1 1/8"	5.44	2.56	0.8960	0.672	0.88
1 1/4"	5.75	2.56	1.0210	0.766	1.00
1 3/8"	6.06	3.00	1.1080	0.831	1.06
1 1/2"	6.38	3.00	1.2330	0.925	1.13

- Please furnish specific material being tapped, type of hole (through, blind or cleared), and depth of hole before threading.
- Taps shown in above table are designed for blind or through holes in free machining steels, cast iron, zinc and aluminum die cast where the length of the hole does not exceed 1-1/2 times the diameter and the threads per inch are not coarser than the standard 60 degree NC threads.



**H.S.S. SPECIAL TANDEM STYLE ACME TAPS**

RIGHT AND LEFT HAND • CLASS OF FIT OTHER THAN 2G

SIZE	OVERALL LENGTH	THREAD LENGTH	SHANK LENGTH	SHANK DIAMETER	SQUARE DIAMETER	SQUARE LENGTH	MAX. DEPTH OF NUT-BRONZE & STEEL	MAX. DEPTH OF NUT-BRASS & CAST IRON
1/4"-16	3.00	1.75	1.00	0.1850	0.138	0.25	0.500	0.750
5/16"-14	3.41	1.88	1.25	0.2200	0.165	0.28	0.630	0.880
3/8"-12	4.06	2.13	1.63	0.2550	0.191	0.31	0.630	1.000
1/2"-10	5.00	2.56	2.00	0.3670	0.275	0.44	1.000	1.500
5/8"-8	6.25	3.19	2.50	0.4800	0.360	0.56	1.250	1.880
3/4"-6	7.94	4.31	3.00	0.5420	0.406	0.63	1.500	2.250
3/4"-8	7.94	4.31	3.00	0.5420	0.406	0.63	1.500	2.250
7/8"-6	8.63	4.38	3.50	0.6970	0.523	0.75	1.750	2.630
1"-5	10.13	5.25	4.00	0.6970	0.523	0.75	2.000	3.000
1 1/8"-5	10.75	5.25	4.50	0.8000	0.600	0.81	2.250	3.380
1 1/4"-5	11.13	5.25	4.75	0.8960	0.672	0.88	2.500	3.750
1 3/8"-4	12.25	5.88	5.13	1.1080	0.831	1.25	2.750	4.130
1 1/2"-4	12.63	5.88	5.50	1.2330	0.925	1.25	3.000	4.500
1 3/4"-4	13.38	5.88	6.25	1.4300	1.072	1.25	3.500	5.000
2"-4	14.88	6.50	7.00	1.6440	1.233	1.38	4.000	6.000

PRODUCT SPECIFICATIONS

SPECIAL TAPS



SOLID CARBIDE TAPS - INCH  
TO TABLE 302-A

SIZE	H LIMIT	# OF FLUTES	ITEM #		OVERALL LENGTH	THREAD LENGTH	SHANK DIAMETER	SQUARE DIAMETER	SQUARE LENGTH	NECK LENGTH
			PLUG	BOTTOM						
#0-80	H2	2	41579	41580	1.63	0.31	0.1410	0.110	0.19	
#2-56	H2	2	41536	41537	1.75	0.44	0.1410	0.110	0.19	
#2-56 SPPT	H2	2	41538		1.75	0.44	0.1410	0.110	0.19	
#4-40	H2	2	41007	41008	1.88	0.31	0.1410	0.110	0.19	0.25
#4-40 SPPT	H2	2	41009		1.88	0.31	0.1410	0.110	0.19	0.25
#4-48	H2	2	41017	41018	1.88	0.31	0.1410	0.110	0.19	0.25
#4-48 SPPT	H2	2	41019		1.88	0.31	0.1410	0.110	0.19	0.25
#5-40	H2	3	41034	41035	1.94	0.31	0.1410	0.110	0.19	0.31
#5-40 SPPT	H2	2	41032		1.94	0.31	0.1410	0.110	0.19	0.31
#6-32	H3	3	41074	41075	2.00	0.38	0.1410	0.110	0.19	0.31
#6-32 SPPT	H3	2	41072		2.00	0.38	0.1410	0.110	0.19	0.31
#6-40	H2	3	41092	41093	2.00	0.38	0.1410	0.110	0.19	0.31
#8-32	H3	4	41125	41126	2.13	0.38	0.1680	0.131	0.25	0.38
#8-32 SPPT	H3	2	41120		2.13	0.38	0.1680	0.131	0.25	0.38
#8-36	H2	4	41147	41148	2.13	0.38	0.1680	0.131	0.25	0.38
#10-24	H3	4	41180	41181	2.38	0.50	0.1940	0.152	0.25	0.38
#10-24 SPPT	H3	2	41175		2.38	0.50	0.1940	0.152	0.25	0.38
#10-32	H3	4	41213	41214	2.38	0.50	0.1940	0.152	0.25	0.38
#10-32 SPPT	H3	2	41208		2.38	0.50	0.1940	0.152	0.25	0.38
#12-24	H3	4	41246	41247	2.38	0.50	0.2200	0.165	0.28	0.44
#12-24 SPPT	H3	2	41241		2.38	0.50	0.2200	0.165	0.28	0.44
#12-28	H3	4	41279	41280	2.38	0.50	0.2200	0.165	0.28	0.44
#12-28 SPPT	H3	2	41274		2.38	0.50	0.2200	0.165	0.28	0.44
1/4"-18 NPT		4	41802		2.50	0.63	0.2550	0.191	0.31	0.38
1/4"-20	H3	4	41312	41313	2.50	0.63	0.2550	0.191	0.31	0.38
1/4"-20 SPPT	H3	2	41307		2.50	0.63	0.2550	0.191	0.31	0.38
1/4"-28	H3	4	41345	41346	2.50	0.63	0.2550	0.191	0.31	0.38
1/4"-28 SPPT	H3	2	41340		2.50	0.63	0.2550	0.191	0.31	0.38
5/16"-18	H3	4	41378	41379	2.72	0.69	0.3180	0.238	0.38	0.44
5/16"-18 SPPT	H3	2	41373		2.72	0.69	0.3180	0.238	0.38	0.44
5/16"-24	H3	4	41411	41412	2.72	0.69	0.3180	0.238	0.38	0.44
5/16"-24 SPPT	H3	2	41406		2.72	0.69	0.3180	0.238	0.38	0.44
3/8"-16	H3	4	41444	41445	2.94	0.75	0.3810	0.286	0.44	0.50
3/8"-16 SPPT	H3	3	41442		2.94	0.75	0.3810	0.286	0.44	0.50
3/8"-24	H3	4	41476	41477	2.94	0.75	0.3810	0.286	0.44	0.50
7/16"-14	H3	4	41520	41521	3.16	0.88	0.3230	0.242	0.41	
7/16"-14 SPPT	H3	3	41522		3.16	0.88	0.3230	0.242	0.41	
7/16"-20	H3	4	41524	41525	3.16	0.88	0.3230	0.242	0.41	
7/16"-20 SPPT	H3	3	41526		3.16	0.88	0.3230	0.242	0.41	
1/2"-13	H3	4	41528	41529	3.38	0.94	0.3670	0.275	0.44	
1/2"-13 SPPT	H3	3	41530		3.38	0.94	0.3670	0.275	0.44	
1/2"-20	H3	4	41532	41533	3.38	0.94	0.3670	0.275	0.44	
1/2"-20 SPPT	H3	3	41534		3.38	0.94	0.3670	0.275	0.44	
9/16"-12 NC	H3	4	47201	47202	3.59	1.00	0.4290	0.322	0.50	
9/16"-18 NF	H3	4	47204	47205	3.59	1.00	0.4290	0.322	0.50	
5/8"-11 NC	H3	4	47207	47208	3.81	1.09	0.4800	0.360	0.56	
5/8"-18 NF	H3	4	47210	47211	3.81	1.09	0.4800	0.360	0.56	
3/4"-10 NC	H3	4	47213	47214	4.25	1.22	0.5900	0.442	0.69	
3/4"-10 NC	H5	4	47228	47229	4.25	1.22	0.5900	0.442	0.69	
3/4"-16 NF	H3	4	47216	47217	4.25	1.22	0.5900	0.442	0.69	
3/4"-16 NF	H5	4	47231	47232	4.25	1.22	0.5900	0.442	0.69	





**SOLID CARBIDE TAPS - METRIC**  
TO TABLE 302-A

SIZE	D #	# OF FLUTES	ITEM #		OVERALL LENGTH	THREAD LENGTH	SHANK DIAMETER	SQUARE DIAMETER	SQUARE LENGTH	NECK LENGTH
			PLUG	BOTTOM						
M3 x 0.50	D3	3	43001	43002	1.94	0.31	0.1410	0.110	0.19	0.31
M3 x 0.50 SPPT	D3	2	43003		1.94	0.31	0.1410	0.110	0.19	0.31
M3.5 x 0.60	D4	3	43005	43006	2.00	0.38	0.1410	0.110	0.19	0.31
M3.5 x 0.60 SPPT	D4	2	43007		2.00	0.38	0.1410	0.110	0.19	0.31
M4 x 0.70	D4	4	43009	43010	2.13	0.38	0.1680	0.131	0.25	0.38
M4 x 0.70 SPPT	D4	2	43011		2.13	0.38	0.1680	0.131	0.25	0.38
M4.5 x 0.75	D4	4	43013	43014	2.38	0.50	0.1940	0.152	0.25	0.38
M4.5 x 0.75 SPPT	D4	2	43015		2.38	0.50	0.1940	0.152	0.25	0.38
M5 x 0.80	D4	4	43017	43018	2.38	0.50	0.1940	0.152	0.25	0.38
M5 x 0.80 SPPT	D4	2	43019		2.38	0.50	0.1940	0.152	0.25	0.38
M6 x 1.00	D5	4	43021	43022	2.50	0.63	0.2550	0.191	0.31	0.38
M6 x 1.00 SPPT	D5	2	43023		2.50	0.63	0.2550	0.191	0.31	0.38
M7 x 1.00	D5	4	43025	43026	2.72	0.69	0.3180	0.238	0.38	0.44
M7 x 1.00 SPPT	D5	2	43027		2.72	0.69	0.3180	0.238	0.38	0.44
M8 x 1.00	D5	4	43033	43034	2.72	0.69	0.3180	0.238	0.38	0.44
M8 x 1.25	D5	4	43029	43030	2.72	0.69	0.3180	0.238	0.38	0.44
M8 x 1.25 SPPT	D5	2	43031		2.72	0.69	0.3180	0.238	0.38	0.44
M10 x 1.50	D6	4	43037	43038	2.94	0.75	0.3810	0.286	0.44	0.50
M10 x 1.50 SPPT	D6	3	43039		2.94	0.75	0.3810	0.286	0.44	0.50
M10 x 1.25	D5	4	43041	43042	2.94	0.75	0.3810	0.286	0.44	0.50
M10 x 1.25 SPPT	D5	3	43043		2.94	0.75	0.3810	0.286	0.44	0.50
M12 x 1.75	D6	4	43045	43046	3.38	0.94	0.3670	0.275	0.44	
M12 x 1.75 SPPT	D6	3	43047		3.38	0.94	0.3670	0.275	0.44	

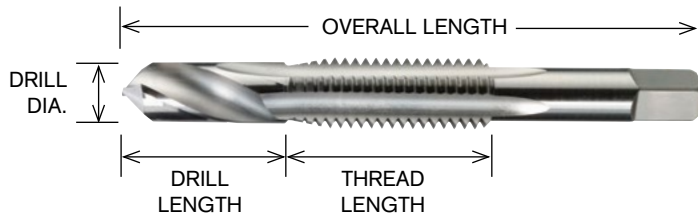


**CARB-I-SERT™**  
CARBIDE INSERT TAPS

SIZE	# OF FLUTES	ITEM #		OVERALL LENGTH	THREAD LENGTH	NECK LENGTH	SQUARE LENGTH	SHANK DIAMETER	SQUARE DIAMETER
		PLUG	BOTTOM						
3/8"-18 NPT/F	4	41808		2.56	0.94	0.50	0.50	0.7000	0.531
1/2"-14 NPT/F	4	41809		3.13	1.19	0.50	0.63	0.6875	0.515
3/4"-14 NPT/F	4	41810		3.25	1.19	0.50	0.69	0.9063	0.679
7/8"-9	4	41558	41559	4.69	1.34	0.50	0.75	0.6970	0.523
7/8"-14	4	41561	41562	4.69	1.34	0.50	0.75	0.6970	0.523
1"-8	4	41564	41565	5.13	1.50	0.50	0.81	0.8000	0.600
1"-11 1/2 NPTF	6	41811		3.75	1.44	0.50	0.81	1.1250	0.843
1"-12	4	41567	41568	5.13	1.50	0.50	0.81	0.8000	0.600
1 1/4"-7	4	41570	41571	5.75	1.72	0.50	1.00	1.0210	0.766
1 3/8"-12	4	41573	41574	6.06	2.00	0.50	1.06	1.1080	0.831
1 1/2"-6	4	41576	41577	6.38	2.00	0.50	1.13	1.2330	0.925

PRODUCT SPECIFICATIONS

SPECIAL TAPS



COST CUTTER™ DRILL & TAP - INCH

SIZE	PITCH	LIMIT	ITEM #	OVERALL LENGTH	THREAD LENGTH	DRILL LENGTH	DRILL DIAMETER
4	40 NC	GH-2	29000	1 7/8	3/8	1/4	.091
6	32 NC	GH-3	29004	2	7/16	5/16	.112
8	32 NC	GH-3	29006	2 1/8	1/2	3/8	.138
10	24 NC	GH-3	29008	2 3/8	5/8	13/32	.155
10	32 NF	GH-3	29009	2 3/8	5/8	13/32	.164
12	24 NC	GH-3	29010	2 3/8	21/32	15/32	.180
1/4	20 NC	GH-3	29012	2 1/2	25/32	17/32	.208
1/4	28 NF	GH-3	29013	2 1/2	25/32	17/32	.220
5/16	18 NC	GH-3	29014	2 23/32	15/16	11/16	.266
5/16	24 NF	GH-3	29015	2 23/32	15/16	11/16	.277
3/8	16 NC	GH-3	29016	2 15/16	1 1/8	13/16	.322
3/8	24 NF	GH-3	29017	2 15/16	1 1/8	13/16	.340
7/16	14 NC	GH-3	29018	3 3/4	1 1/4	1	.377
7/16	20 NF	GH-3	29019	3 3/4	1 1/4	1	.395
1/2	13 NC	GH-3	29020	4 1/16	1 3/8	1 1/8	.435
1/2	20 NF	GH-3	29022	4 1/16	1 3/8	1 1/8	.458
5/8	11 NC	GH-3	29036	5 1/16	1 3/4	1 1/2	.548

COST CUTTER™ DRILL & TAP - METRIC

SIZE	PITCH	LIMIT	ITEM #	OVERALL LENGTH	THREAD LENGTH	DRILL LENGTH	DRILL DIAMETER
M3	.5	D3	29024	1 15/16	13/32	9/32	.102
M3.5	.6	D4	29025	2	7/16	5/16	.120
M4	.7	D4	29026	2 1/8	1/2	3/8	.134
M4.5	.75	D4	29027	2 3/8	5/8	13/32	.152
M5	.8	D4	29028	2 3/8	5/8	13/32	.172
M6	1	D5	29029	2 1/2	25/32	17/32	.203
M7	1	D5	29030	2 23/32	15/16	11/16	.242
M8	1.25	D5	29031	2 23/32	15/16	11/16	.274
M10	1.50	D6	29032	2 15/16	1 1/8	13/16	.344
M12	1.75	D6	29033	4 1/16	1 3/8	1 1/8	.414

COST CUTTER™ DRILL & TAP - PIPE SIZES (NPT/F)

SIZE	PITCH	ITEM #	OVERALL LENGTH	THREAD LENGTH	DRILL LENGTH	DRILL DIAMETER
1/16	27	29040	2 13/16	11/16	11/16	.242
1/8	27	29041	2 7/8	3/4	3/4	.332
1/4	18	29042	3 5/16	1 1/16	7/8	.438
3/8	18	29043	3 1/2	1 1/16	15/16	.562
1/2	14	29044	4 3/8	1 3/8	1 1/4	.703
3/4	14	29045	4 9/16	1 3/8	1 5/16	.906
1	11 1/2	29046	5 3/8	1 3/4	1 5/8	1.141



**SPECIAL DIES AND ADAPTERS**

**HEX ADAPTERS**

ITEM #	DESCRIPTION
13650	Die OD 1"
13651	Die OD 1-1/2"
13652	Die OD 2"
13653	Die OD 2-1/2"
13654	(Fine) Die OD 3"
13655	(Coarse) Die OD 3"

**HEX DIES**

ITEM #	METRIC
1/4	M6
5/16	M8
3/8, 7/16	M11
1/2, 9/16	M14
5/8	M16
11/16, 3/4	M18
7/8	M22
1"	M25
1 1/8	M28
1 1/4	M31
1 3/8	M33
1 1/2	M38
1 5/8, 1 3/4, 1 7/8	M45
2", 2 1/8, 2 1/4	M56
2 3/8, 2 1/2, 2 5/8, 2 3/4	M69
2 7/8, 3", 3 1/4, 3 3/8, 3 1/2	M88

**ROUND AND ADJUSTABLE DIES**

SIZE	METRIC	OD	MAX. TPI
#4 - 3/8"	M3 - M9	1"	80
7/16" - 5/8"	M10 - M18	1 1/2"	40
11/16" - 1 1/16"	M19 - M27	2"	40
1 1/8" - 1 1/2"	M30 - M38	2 1/2"	28
1 9/16" - 2"	M39 - M48	3"	28

**DIE THICKNESS CHART**

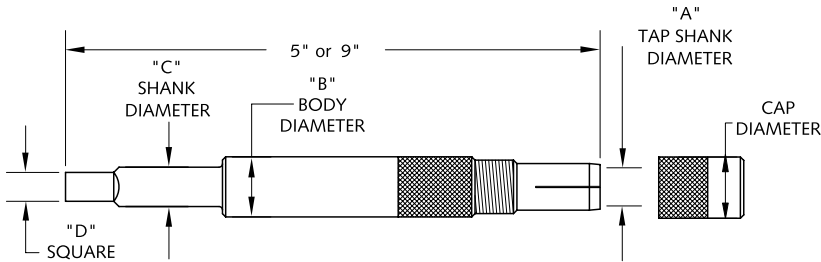
O.D.(INCH)	O.D.(MM)	THICKNESS
13/16	20.6 mm	1/4
1"	25.4 mm	3/8
1-1/2	38.1 mm	1/2
2"	50.8 mm	5/8
2-1/2	63.5 mm	3/4
3" (10 pitch & coarser)	76.2 mm	1"
3" (11 pitch & finer)	76.2 mm	3/4



**Need Safety Data Sheets (S.D.S.)?**

Contact a customer service associate or visit our website:  
[www.natool.com](http://www.natool.com)

# TAP EXTENSIONS FOR ANSI STANDARD TAPS



The tap shank enters the hole and is locked into a square in the bottom of the hole. The tap is then secured by hand tightening the compression cap.



5" Tap Extension Set w/Case (9-piece) shown. Also available in 9" Sets.

- Hand Tap Extensions 5" & 9" Length
- Made from tool steel.
- Internal square drive for positive tap drive.
- Compression cap for easy tightening. No wrench required.
- A very effective tool at low cost.
- The slim profile lets you fit into places not accessible to conventional tap extensions.
- Eliminates the need for purchasing expensive extended length taps.
- Integral compression collet eliminates the need for bulky collet nuts.

[Click on EDP # for Price List](#)

EDP NUMBER	NOMINAL TAP SIZE	METRIC TAP SIZE ASME/ANSI B94.9 - 1987	DIA OF TAP SHANK (INCH)	EXT DIA (INCH)	SHANK DIA (INCH)	SQUARE SIZE (INCH)	DEPTH TAP ENTERS
<b>5" TAP EXTENSIONS (CAP Diameter = "B" Body Diameter)</b>							
21700	#0-#6	M1.6-M3.5	0.141	1/4"	0.194	0.152	7/8"
21701	#8	M4	0.168	5/16"	0.194	0.152	7/8"
21702	#10	M4.5-M5	0.194	3/8"	0.194	0.152	1"
21703	#12		0.22	3/8"	0.194	0.152	1"
21704	1/4"	M6-M6.3	0.255	7/16"	0.255	0.191	1"
21705	5/16"	M7 & M8	0.318	1/2"	0.318	0.238	1 1/16"
21706	3/8"	M10	0.381	9/16"	0.381	0.286	1 1/8"
21707	7/16"		0.323	1/2"	0.323	0.242	1 1/16"
21708	1/2"	M12	0.367	9/16"	0.367	0.275	1 1/8"
21709	1/16 & 1/8 RS NPT		0.312	1/2"	0.312	0.234	1"
21796	5" Tap Extension Set w/Case (9-piece set includes EDP No. 21700 thru 21708)						
<b>9" TAP EXTENSIONS (CAP Diameter = "B" Body Diameter)</b>							
21805	#0-#6	M1.6-M3.5	0.141	1/4"	0.194	0.152	7/8"
21710	#8	M4	0.168	5/16"	0.194	0.152	7/8"
21711	#10	M4.5-M5	0.194	3/8"	0.194	0.152	1"
21712	#12		0.22	3/8"	0.194	0.152	1"
21713	1/4"	M6	0.255	7/16"	0.255	0.191	1"
21714	5/16"	M7 & M8	0.318	1/2"	0.318	0.238	1 1/16"
21715	3/8"	M10	0.381	9/16"	0.381	0.286	1 1/8"
21716	7/16"		0.323	1/2"	0.323	0.242	1 1/16"
21717	1/2"	M12	0.367	9/16"	0.367	0.275	1 1/8"
21718	1/16 & 1/8 RS NPT		0.312	1/2"	0.312	0.234	1"
21797	9" Tap Extension Set w/Case (9-piece set includes EDP No. 21805 thru 21717)						
<b>6" TAP EXTENSIONS (For Taps Larger Than 1/2") (CAP Diameter = 1/8" Greater than "B" Body Diameter)</b>							
21719	9/16"		0.429	3/4"	0.429	0.320	1 1/4"
21720	1/8 NPT		0.437	3/4"	0.437	0.328	1"
21721	5/8"	M16	0.480	3/4"	0.480	0.360	1 1/4"
21722	11/16"		0.542	7/8"	0.542	0.406	1 1/4"
21723	1/4 NPT		0.562	7/8"	0.562	0.420	1"
21724	3/4"		0.590	7/8"	0.590	0.440	1 3/8"
21725	7/8"		0.697	1"	0.697	0.520	1 3/8"
21726	3/8 NPT		0.700	1"	0.700	0.530	1 3/16"
21727	1/2 NPT		0.687	1"	0.687	0.515	1 1/4"
21798	1"		0.800	1"	0.800	0.600	1 1/2"

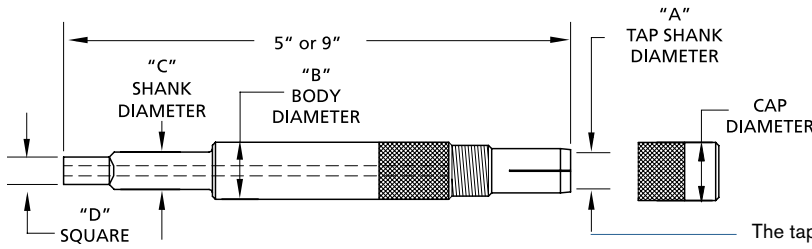


Specify quantity, EDP number, tap size and extension length.





# FOR COOLANT-THROUGH ANSI STANDARD TAPS



The tap shank enters the hole and is locked into a square in the bottom of the hole. The tap is then secured by hand tightening the compression cap.

- Coolant-Through Hand Tap Extensions 5" & 9" Length
- Made from tool steel.
- Internal square drive for positive tap drive.
- Compression cap for easy tightening. No wrench required.
- A very effective tool at low cost.
- The slim profile lets you fit into places not accessible to conventional tap extensions.
- Eliminates the need for purchasing expensive extended length taps.
- Integral compression collet eliminates the need for bulky collet nuts.

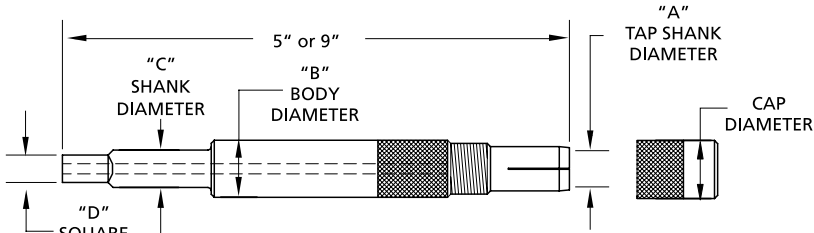


[Click on EDP # for Price List](#)

EDP NUMBER	NOMINAL TAP SIZE	METRIC TAP SIZE ASME/ANSI B94.9 - 1987	DIA OF TAP SHANK (INCH)	EXT DIA (INCH)	SHANK DIA (INCH)	SQUARE SIZE (INCH)	DEPTH TAP ENTERS	COOLANT HOLE DIA
<b>5" COOLANT THRU TAP EXTENSIONS (CAP Diameter = "B" Body Diameter)</b>								
21728	#0-#6	M1.6-M3.5	0.141	1/4"	0.194	0.152	7/8"	7/64
21729	#8	M4	0.168	5/16"	0.194	0.152	7/8"	7/64
21730	#10	M4.5-M5	0.194	3/8"	0.194	0.152	1"	7/64
21731	#12		0.22	3/8"	0.194	0.152	1"	7/64
21732	1/4"	M6-M6.3	0.255	7/16"	0.255	0.191	1"	3/32
21733	5/16"	M7 & M8	0.318	1/2"	0.318	0.238	1 1/16"	5/32
21734	3/8"	M10	0.381	9/16"	0.381	0.286	1 1/8"	5/32
21735	7/16"		0.323	1/2"	0.323	0.242	1 1/16"	5/32
21736	1/2"	M12	0.367	9/16"	0.367	0.275	1 1/8"	5/32
21799	1/16 & 1/8 RS NPT		0.312	1/2"	0.312	0.234	1"	5/32
<b>9" COOLANT THRU TAP EXTENSIONS (CAP Diameter = "B" Body Diameter)</b>								
21737	#0-#6	M1.6-M3.5	0.141	1/4"	0.194	0.152	7/8"	7/64
21738	#8	M4	0.168	5/16"	0.194	0.152	7/8"	7/64
21739	#10	M4.5-M5	0.194	3/8"	0.194	0.152	1"	7/64
21740	#12		0.22	3/8"	0.194	0.152	1"	7/64
21741	1/4"	M6-M6.3	0.255	7/16"	0.255	0.191	1"	3/32
21742	5/16"	M7 & M8	0.318	1/2"	0.318	0.238	1 1/16"	5/32
21743	3/8"	M10	0.381	9/16"	0.381	0.286	1 1/8"	5/32
21744	7/16"		0.323	1/2"	0.323	0.242	1 1/16"	5/32
21745	1/2"	M12	0.367	9/16"	0.367	0.275	1 1/8"	5/32
21800	1/16 & 1/8 RS NPT		0.312	1/2"	0.312	0.234	1"	5/32
<b>6" COOLANT THRU TAP EXTENSIONS (For Taps Larger Than 1/2") (CAP Diameter = 1/8" Greater than "B" Body Diameter)</b>								
21746	9/16"		0.429	3/4"	0.429	0.320	1 1/4"	3/16
21747	1/8 NPT		0.437	3/4"	0.437	0.328	1"	3/16
21748	5/8"	M16	0.480	3/4"	0.48	0.360	1 1/4"	3/16
21749	11/16"		0.542	7/8"	0.542	0.406	2 1/4"	3/16
21750	1/4 NPT		0.562	7/8"	0.562	0.420	1"	3/16
21751	3/4"		0.590	7/8"	0.59	0.440	1 3/8"	3/16
21752	7/8"		0.697	1"	0.697	0.520	1 3/8"	3/16
21753	3/8 NPT		0.700	1"	0.7	0.530	1 3/16"	3/16
21754	1/2 NPT		0.687	1"	0.687	0.515	1 1/4"	3/16
21755	1"		0.800	1"	0.8	0.600	1 1/2"	3/16

Specify quantity, EDP number, tap size and extension length.

# TAP EXTENSIONS FOR DIN STANDARD TAPS



The tap shank enters the hole and is locked into a square in the bottom of the hole. The tap is then secured by hand tightening the compression cap.

- Metric DIN Hand Tap Extensions 5" & 9" Length
- All popular DIN metric sizes.
- All the most popular sizes available for coolant-through taps.
- Made from tool steel.
- Internal square drive for positive tap drive.
- Compression cap for easy tightening. No wrench required.
- A very effective tool at low cost.
- The slim profile lets you fit into places not accessible to conventional tap extensions.
- Eliminates the need for purchasing expensive extended length taps.
- Integral compression collet eliminates the need for bulky collet nuts.

[Click on EDP # for Price List](#)

[Click on EDP # for Price List](#)

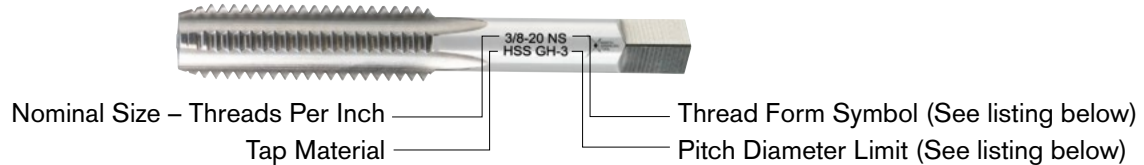
EDP NUMBER	TAPS WITH DIN 371 SHANKS	TAPS WITH DIN 374/376 SHANKS	DIA OF TAP SHANK (MM)	DIA OF SHANK (INCH)	DEPTH TAP ENTERS	EXT DIA	SHANK DIA (MM)	SHANK DIA (INCH)	SQUARE SIZE (MM)	SQUARE SIZE (INCH)	WITH COOLANT HOLE	
											EDP NUMBER	COOLANT HOLE SIZE
<b>5" (127mm) LONG TAP EXTENSIONS (CAP Diameter = "B" Body Diameter)</b>												
21756	M2-M2.6	M4	2.8mm	(0.110)	7/8"	1/4"	6mm	(0.236)	4.9mm	(0.193)	21776	2.36mm
21757	M3	M4.5-M5	3.5mm	(0.137)	7/8"	5/16"	6mm	(0.236)	4.9mm	(0.193)	21777	2.36mm
21758	M3.5	M5.5	4.0mm	(0.157)	7/8"	3/8"	6mm	(0.236)	4.9mm	(0.193)	21778	2.36mm
21759	M4	M6	4.5mm	(0.177)	7/8"	3/8"	6mm	(0.236)	4.9mm	(0.193)	21779	2.36mm
21760	M4.5-M6	M8	6.0mm	(0.236)	1"	7/16"	7mm	(0.275)	5.5mm	(0.216)	21780	3.96mm
21761	M7	M9-M10	7.0mm	(0.275)	1"	1/2"	7mm	(0.275)	5.5mm	(0.216)	21781	3.96mm
21762	M8	M11	8.0mm	(0.315)	1 1/8"	1/2"	8mm	(0.315)	6.2mm	(0.244)	21782	3.96mm
21763	M9	M12	9.0mm	(0.354)	1 3/16"	5/8"	9mm	(0.354)	7mm	(0.275)	21783	3.96mm
21764	M10		10.0mm	(0.393)	1 1/4"	5/8"	10mm	(0.393)	8mm	(0.315)	21784	3.96mm
21765		M14	11.0mm	(0.433)	1 3/8"	3/4"	11mm	(0.433)	9mm	(0.354)	21785	3.96mm
21801	M12	M16	12.0mm	(0.472)	1 3/8"	3/4"	12mm	(0.472)	9mm	(0.354)	21803	3.96mm
<b>9" (228.6mm) TAP EXTENSIONS (CAP Diameter = "B" Body Diameter)</b>												
21766	M2-M2.6	M4	2.8mm	(0.110)	7/8"	1/4"	6mm	(0.236)	4.9mm	(0.193)	21786	2.36mm
21767	M3	M4.5-M5	3.5mm	(0.137)	7/8"	5/16"	6mm	(0.236)	4.9mm	(0.193)	21787	2.36mm
21768	M3.5	M5.5	4.0mm	(0.157)	7/8"	3/8"	6mm	(0.236)	4.9mm	(0.193)	21788	2.36mm
21769	M4	M6	4.5mm	(0.177)	7/8"	3/8"	6mm	(0.236)	4.9mm	(0.193)	21789	2.36mm
21770	M4.5-M6	M8	6.0mm	(0.236)	1"	7/16"	7mm	(0.275)	5.5mm	(0.216)	21790	3.96mm
21771	M7	M9-M10	7.0mm	(0.275)	1"	1/2"	7mm	(0.275)	5.5mm	(0.216)	21791	3.96mm
21772	M8	M11	8.0mm	(0.315)	1 1/8"	1/2"	8mm	(0.315)	6.2mm	(0.244)	21792	3.96mm
21773	M9	M12	9.0mm	(0.354)	1 3/16"	5/8"	9mm	(0.354)	7mm	(0.275)	21793	3.96mm
21774	M10		10.0mm	(0.393)	1 1/4"	5/8"	10mm	(0.393)	8mm	(0.315)	21794	3.96mm
21775		M14	11.0mm	(0.433)	1 3/8"	3/4"	11mm	(0.433)	9mm	(0.354)	21795	3.96mm
21802	M12	M16	12.0mm	(0.472)	1 3/8"	3/4"	12mm	(0.472)	9mm	(0.354)	21804	3.96mm

Specify quantity, EDP number, tap size and extension length.



## STANDARD SYSTEM OF TAP MARKING

Taps, dies and other types of threading tools are marked according to the Standard System of Marking Ground Thread Taps. Tools are marked with the nominal size, number of threads per inch (pitch), and the appropriate thread form symbol and pitch diameter symbol. Symbols typically used are listed.



### PITCH DIAMETER LIMIT SYMBOLS

All standard ground thread taps are marked with the letter "G" to designate Ground Thread. The letter G will be followed by the letter "H" to designate above basic; or the letter "L" to designate below basic. The number following H or L signifies the number of .0005" steps above or below the basic pitch diameter. *For instance, the tap pictured above is a 3/8" dia. tap with 20 threads per inch (pitch), and has a NS (American National Special Thread) thread form. The tap is made from High Speed Steel, and the GH-3 pitch diameter limit symbol indicates a Ground Thread tap with pitch diameter limits .0010 to .0015 over basic.*

Pitch Diameter Limits for taps to 1" diameter inclusive:

- L1 = Basic to Basic minus .0005
- H1 = Basic to Basic plus .0005
- H2 = Basic plus .0005 to Basic plus .0010
- H3 = Basic plus .0010 to Basic plus .0015
- H4 = Basic plus .0015 to Basic plus .0020
- H5 = Basic plus .0020 to Basic plus .0025
- H6 = Basic plus .0025 to Basic plus .0030

Taps larger than 1" dia. are ground to a .0010" tolerance on the pitch diameter and are, for example,

- H4 (Basic plus .0010" to Basic plus .0020" ).

### THREAD FORM SYMBOLS

ACME-C	Acme Thread-Centralizing
ACME-G	Acme Thread-General Purpose
AMO	American Standard Microscope Objective Thread
ANPT	Aeronautical National Form Taper Pipe Thread (Ground thread tap marked NPT)
BA	British Association Standard Thread
BSF	British Standard Fine Thread Series
BSP	British Standard Pipe
BSPP	British Standard Pipe (Parallel) Thread
BSPT	British Standard Taper Pipe Thread
BSW	British Standard Whitworth Coarse Thread Series
M	Metric Screw Thread Series
N	American National 8, 12 and 16 Thread Series (8N, 12N, 16N)
NBUTT	American Buttress Screw Thread
NC	American National Coarse Thread Series
NEF	American National Extra Fine Thread Series
NF	American National Fine Thread Series
NGO	National Gas Outlet Thread
NGT	National Gas Taper Thread (see "SGT")
NH	American National Hose Coupling and Fire Hose Coupling Threads
NPS	For tap marking only (See NPSC, NPSM)
NPSC	American National Standard Straight Pipe Thread in Pipe Couplings (Tap marked NPS)
NPSF	Dryseal American National Standard Fuel Internal Straight Pipe Thread
NPSH	American National Standard Straight Pipe Thread for Hose Couplings
NPSI	Dryseal American National Standard Intermediate Internal Straight Pipe Thread
NPSL	American National Standard Straight Pipe Thread for Loose Fitting Mechanical Joints with Locknuts
NPSM	American National Standard Straight Pipe Threads for Free-Fitting Mechanical Joints for Fixtures (Tap marked NPS)
NPT	American National Standard Taper Pipe Thread (See ANPT, NPTR)

NPTF	Dryseal American National Standard Taper Pipe Thread
NPTR	American National Standard Taper Pipe Thread for Railing Joints (Tap marked NPT)
NS	American National Thread-Special
PG	Panzer Gewinde
PTF	Dryseal SAE Short Taper Pipe Thread
SGT	Special Gas Taper Thread
SPL-PTF	Dryseal Special Taper Pipe Thread
STI	Special Thread for Helical Coil Wire Screw Thread Inserts
Stub Acme	Stub Acme Thread
*UN	Unified Constant Pitch Thread Series
*UNC	Unified Coarse Thread Series
*UNEF	Unified Extra Fine Thread Series
*UNF	Unified Fine Thread Series
UNJ**	Unified Thread Series with a 0.15011P to 0.18042P Controlled Root Radius on External Thread only.
UNJC	Unified Coarse Thread Series with a 0.15011P to 0.18042P Controlled Root Radius on External Thread only.
UNJF	Unified Fine Thread Series with a 0.15011P to 0.18042P Controlled Root Radius on External Thread only.
UNM	Unified Miniature Thread Series
UNR	Unified Constant Pitch Thread Series with a 0.108P to 0.144P Controlled Root Radius; Ext. thread only.
UNRC	Unified Coarse Thread Series with a 0.108P to 0.144P Controlled Root Radius; Ext. thread only.
UNRF	Unified Fine Thread Series with a 0.108P to 0.144P Controlled Root Radius; External thread only.
*UNS	Unified Thread-Special
V	A 60° "V" thread with Truncated Crest and Root. The theoretical "V" Form is usually flattened to the user's specifications.
WHIT	British Standard Whitworth Special Thread

\* Taps are not marked with "U" but with the symbol for the corresponding American Standard thread form with which it is compatible.

\*\* See page 100 for additional information on UNJ taps.

INCH SCREW THREADS - UNJ PROFILE  
Controlled Root Radius with Increased Minor Diameter

The UNJ thread standard (ASME B1.15) defines a system of threads for highly stressed applications requiring high fatigue strength. It was derived from a military specification (MIL-S-8879). MIL-S-8879 was primarily thought of and used for aerospace fastener and threaded component applications. Due to the increase in both its use and types of applications, the American Society of Mechanical Engineers developed and published ASME B1.15 in 1995.

**FORM.** UNJ screw threads are of the same form as Unified Screw Threads to ASME/ANSI B1.1 except:

*External threads:* the root has a maximum and minimum prescribed continuous radius, and is not merely rounded due to tool wear.

*Internal threads:* the minor diameter is increased to accommodate the maximum root radius of the external thread. There is no radius requirement for either the crest or the root of the internal thread.

**Designation.** UNJ product threads are identified by the letter "J" in the thread symbol, and a thread class symbol including an "A" for external threads or a "B" for internal threads.

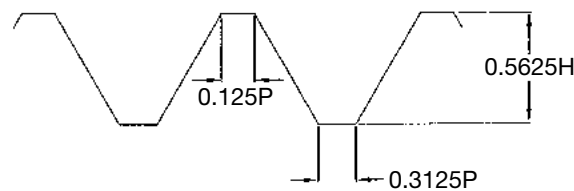
**Use of Unified Tooling.** Many of the UNJ thread form characteristics are the same as for UN threads. Therefore, some of the tooling used to produce one form can be used to produce the other.

*External UNJ threads* must be produced with a prescribed root radius; therefore, standard Unified Screw Thread (UN) tooling may not be used.

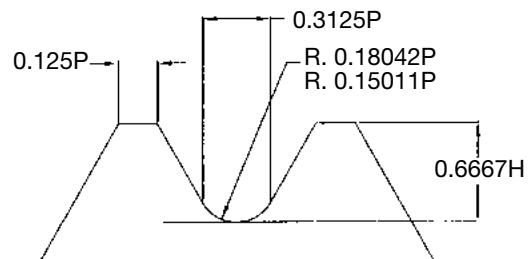
*Internal UNJ threads* are not required to have a root radius; therefore, ground thread taps designed to produce Unified Screw Threads of the proper class of fit may be used. The letter "J" need not be marked on the tap. The larger product minor diameter of the UNJ internal thread requires the use of a larger tap drill than is used when producing Unified Screw Threads.

- UNJ Thread Form: Unified Thread Series with a 0.15011P to 0.18042P controlled root radius on external thread only. (As defined by MIL-S-8879C)
- UNJ internal threads do not require radius; only external thread requires radius on root.
- UNJ external thread assembles only with UNJ internal thread.
- UNJ tap is standard 2B or 3B class of fit.

UNJ INTERNAL THREAD  
Root to Clear 0.125P Width-Flat or Rounded  
Assembles With All UN External Threads



UNJ CLASSES 3B AND 3BG  
NO RADIUS REQUIRED ON  
INTERNAL THREADS



UNJ EXTERNAL THREAD  
Assembles Only With UNJ Internal





**CLASSES OF THREADS AND TAP SIZE:** There is a direct relationship between the size of a tap and the size of the thread that it cuts. Size refers to pitch diameter and its relationship to the class of fit required. If two threaded parts are assembled, the looseness or tightness of the fit is determined by contact on the flanks of the threads only. This contact is controlled by the pitch diameters of each part.

**CLASSES OF THREAD:** When threaded parts are mated, the two parts must assemble with a degree of tightness dictated by the use of the fastener. In addition, the internal thread must be large enough to allow the external thread to enter it for the required length of engagement. A system of thread classes, each representing a comparative degree of tightness, has been established and universally adopted, to provide manufacturers and users of threaded products with a common language of specification. The thread classes designate minimum and maximum pitch diameters for internal and external threads. It is important to remember that classes of thread actually represents manufacturing tolerances. The closer the tolerance required, the higher the cost involved in producing the parts. Therefore, designers and engineers should always try to select the class of thread with the widest permissible tolerance.

**TAP SIZE:** Due to material variability and machining conditions, taps rarely cut their own size. The thread size produced is usually larger, but can be smaller due to shrinkage. Tap manufacturers realized that to tap a specified class of thread, several different ground thread tap limits would be required. These limits represent small, defined variations in tap size. A numbering system was developed to designate each series of

limits, but these limit numbers are not to be confused with the classes of threads. Ground thread tap limits are designated by the letter H (high) above basic pitch diameter, or L (low) below basic pitch diameter, and these numbers establish the tolerance range in relation to basic pitch diameter. As an example, in sizes 1" and smaller, an H1 tap has a tolerance range of from basic to .0005" over basic; an H2 tap from .0005" over basic to .001" over basic, (see chart 1A on this page). In addition, metric threads are also designated in much the same way. The thread tap limits are designated by the letter D (ground, high) above basic pitch diameter, or U (ground, low) below basic pitch diameter. As an example, in sizes M25 and smaller, a D1 tap has a size of .0005" over basic to tap max. P.D.; a D2 tap has a size of .001" over basic to tap max. P.D., (see Chart 1B). The Tables on pages 115-117 list recommended limit numbers for different classes of thread. Several different limit numbers are available for each diameter and pitch combination. Consequently, it is possible to select the "H" or "L" limit, or the "D" or "U" limit most suitable for the required tapping operation. Please contact our Customer Service Dept. for questions regarding tap limits and their relation to classes of fit.

#### CHART 1A

Pitch Diameter Limits for taps to 1" diameter inclusive:

L1 = Basic to Basic minus .0005

H1 = Basic to Basic plus .0005

H2 = Basic plus .0005 to Basic plus .0010

H3 = Basic plus .0010 to Basic plus .0015

H4 = Basic plus .0015 to Basic plus .0020

H5 = Basic plus .0020 to Basic plus .0025

H6 = Basic plus .0025 to Basic plus .0030

Taps larger than 1" dia. are ground to a .0010" tolerance on the pitch diameter and are, for example, H4 (Basic plus .0010" to Basic plus .0020").

#### CHART 1B

Pitch Diameter Limits for taps to 1" diameter inclusive: (Metric taps generally have more manufacturing tolerance than .0005 to the minus side.)

U1 = Basic minus .0005 = min. tap P.D.

D1 = Basic plus .0005 = max. tap P.D.

D2 = Basic plus .0010 = max. tap P.D.

D3 = Basic plus .0015 = max. tap P.D.

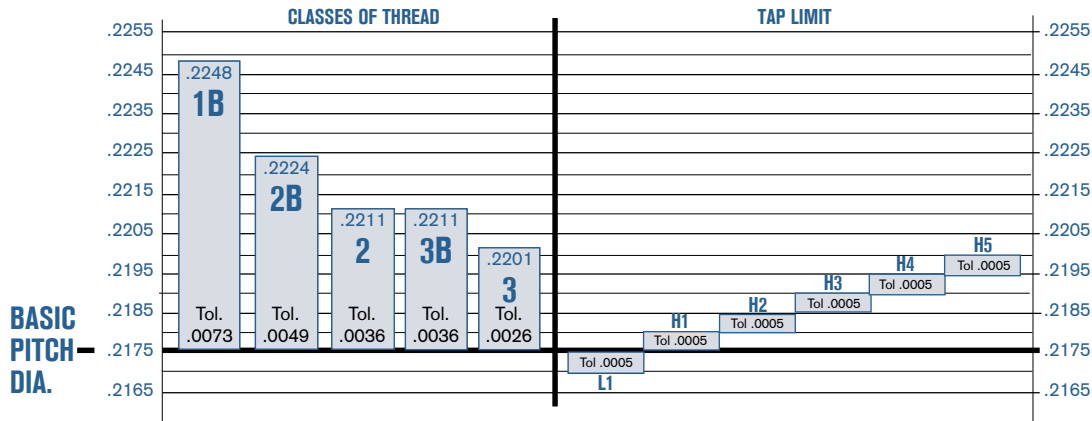
D4 = Basic plus .0020 = max. tap P.D.

D5 = Basic plus .0025 = max. tap P.D.

D6 = Basic plus .0030 = max. tap P.D.



CHART 2A COMPARISON OF PITCH DIAMETER LIMITS TO CLASS OF FIT



On Charts 2A and 2B (below), examples of the relationship of Class of Fit to various tap limit sizes is shown for both Imperial and Metric sizes. In chart 2A, using a 1/4"-20NC or UNC thread size, it is obvious that an H5 limit (+.0025" over basic pitch diameter) can be used to cut the tightest class of thread in most machining situations, as can the H1 limit (+.0005" over basic P.D.). However, tool wear would force the discarding of the H1 tap long before the H5 would be worn to an undersize condition. The rule is obvious: always select the largest "H" limit possible to achieve proper class of fit, and maximum tool life.

CHART 2B COMPARISON OF PITCH DIAMETER LIMITS TO CLASS OF FIT

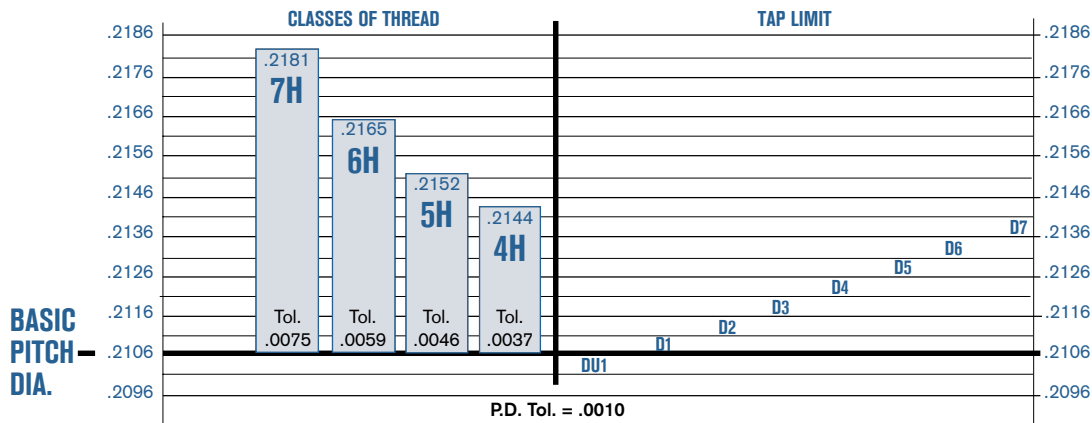


Chart 2B shows the same relationship with a metric thread. Using a M6 X 1.0, it is obvious that a D5 limit (+.0025" over basic pitch diameter) can be used to cut the standard class of thread in most machining situations, as can the D1 limit (+.0005" over basic P.D.). However, tool wear would force the discarding of the D1 tap long before the D5 would be worn to an undersize condition. The rule is obvious: always select the largest "D" limit possible to achieve proper class of fit, and maximum tool life.

**SCREW THREAD CLASSES OVERVIEW:** Screw thread classes are distinguished from each other by the amount of tolerance and allowance.

**Class 1A and Class 1B:** The combination of Class 1A for external threads and Class 1B for internal threads is intended to cover the manufacture of threaded parts where quick and easy assembly is necessary or desired, and an allowance is provided to permit ready assembly.

**Class 2A and Class 2B:** The combination of Class 2A for external threads and Class 2B for internal threads designed for screws, bolts and nuts, is also suitable for a variety of other applications. A similar allowance

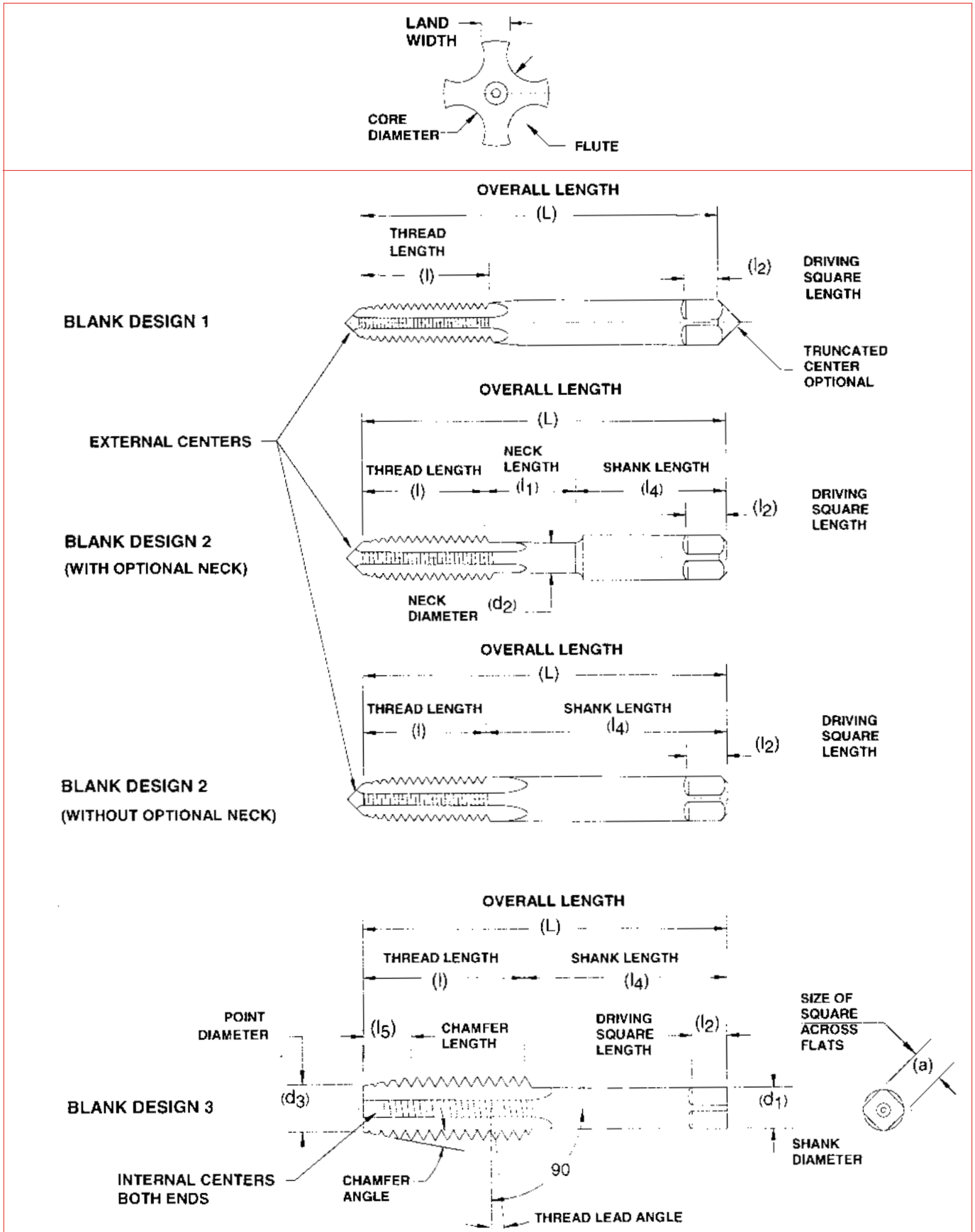
is provided which minimizes galling and seizure encountered in assembly and use. It also accommodates, to a limited extent, plating, finishes or coatings.

**Class 3A and 3B:** The combination of Class 3A for external threads and Class 3B for internal threads is provided for those applications where closeness of fit and accuracy of lead and angle of thread are important. These threads are obtained consistently only by use of high quality production equipment supported by a very efficient system of gauging and inspection.

No allowance is provided.

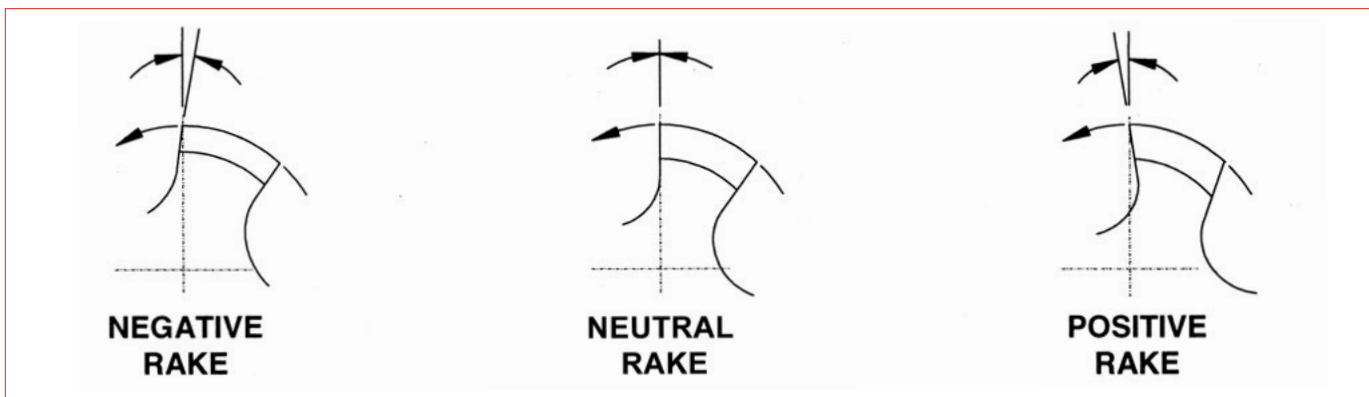
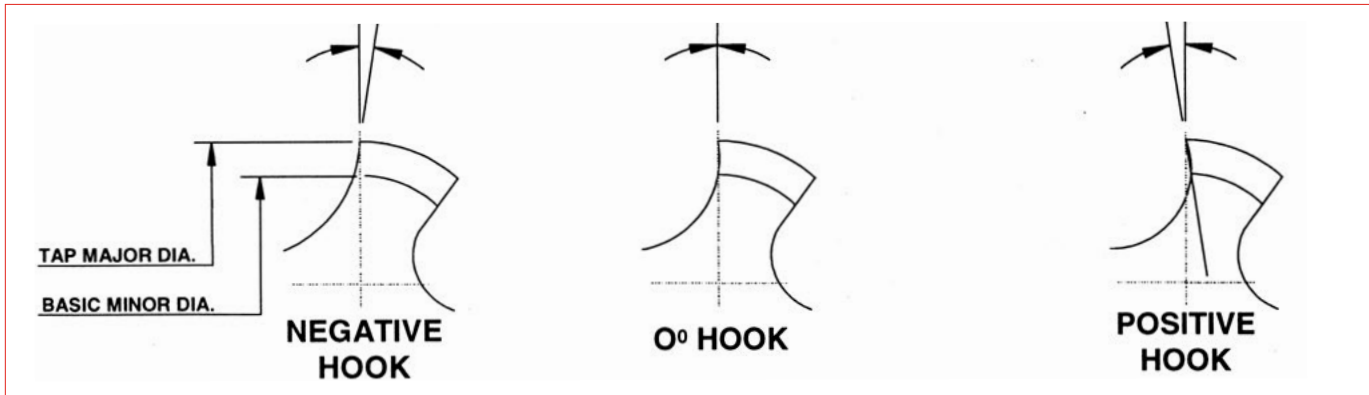
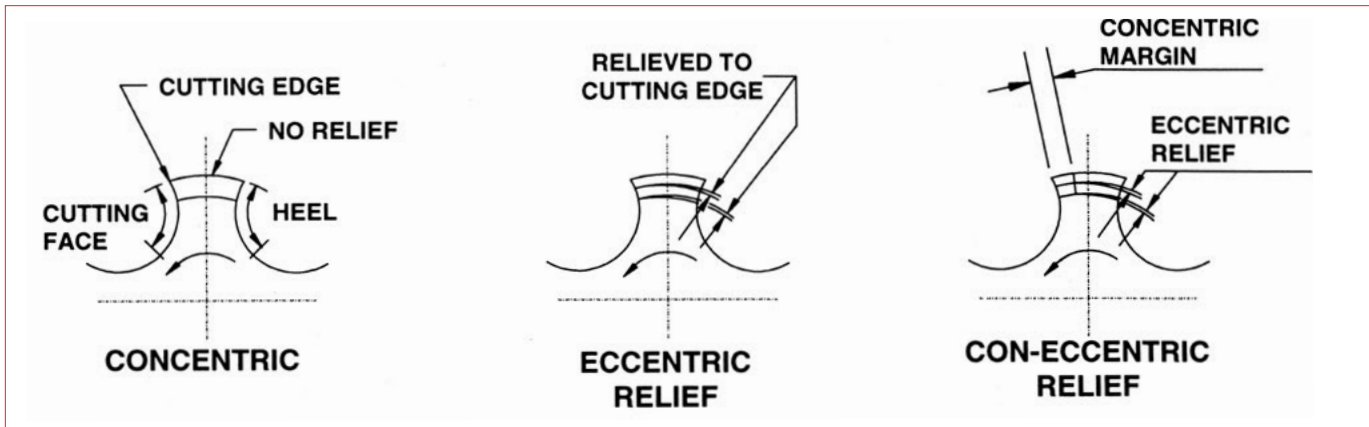
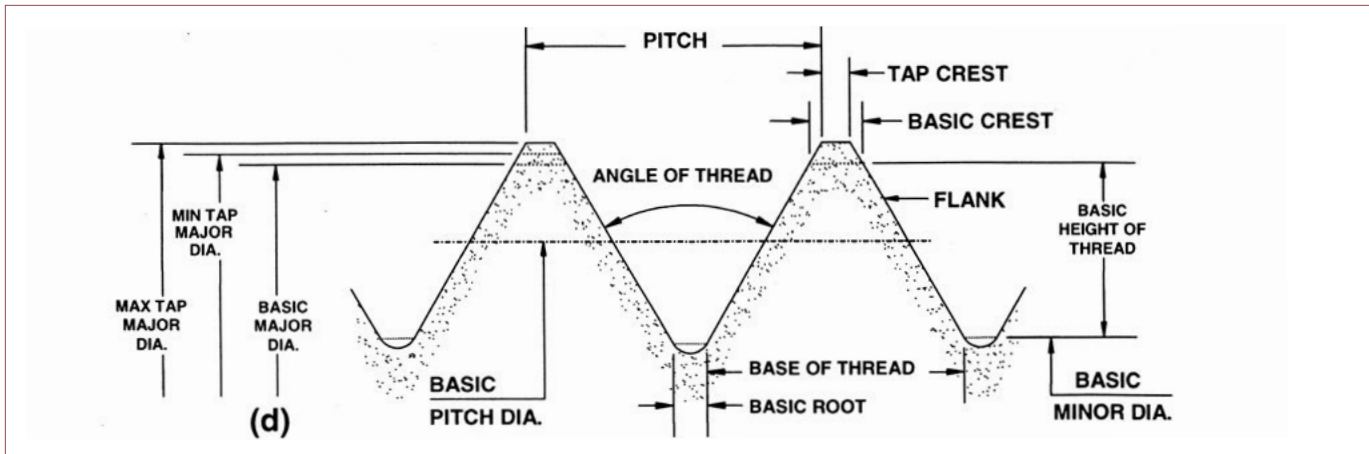


ILLUSTRATION OF TERMS APPLYING TO TAPS





# ILLUSTRATION OF TERMS APPLYING TO TAPS



## DEFINITION OF TERMS APPLYING TO TAPS

### ALLOWANCE

Minimum clearance between two mating parts; the prescribed variations from the basic size.

### ANGLE OF THREAD

The angle included between the sides of the thread measured in an axial plane.

### AXIS

The imaginary straight line that forms the longitudinal centerline of the tool or threaded part.

### BACK TAPER

A gradual decrease in the diameter of the thread form on a tap from the chamfered end of the land towards the back which creates a slight radial relief in the threads.

### BASE OF THREAD

The bottom section of the thread; the greatest section between the two adjacent roots.

### BASIC SIZE

The theoretical or nominal standard size from which all variations are derived by application of allowances and tolerances.

### CHAMFER

The tapering of the threads at the front end of each land of a tap by cutting away and relieving the crest of the first few teeth to distribute the cutting action over several teeth; Taper taps are chamfered 7-10 threads; plug taps are chamfered 3-5 threads; semi bottoming taps are chamfered 2-2.5 threads; bottoming taps are chamfered 1-2 threads; taper pipe taps are chamfered 2-3.5 threads.

### CHAMFER RELIEF

The gradual decrease in land height from cutting edge to heel on the chamfered portion, to provide clearance for the cutting action as the tap advances.

### CREST

The top surface joining the two sides or flanks of the thread; the crest of an external thread is at its major diameter, while the crest of an internal thread is at its minor diameter.

### CUTTING FACE

The leading side of the land in the direction of cutting rotation on which the chip forms.

### FLUTE

The longitudinal channels formed in a tap to create cutting edges on the thread profile, and to provide chip spaces and cutting fluid passages.

### HEEL

The edge of the land opposite the cutting edge.

### HEIGHT OF THREAD

The distance, measured radially, between the crest and the base of a thread.

### HELIX ANGLE

The angle made by the advance of the thread as it wraps around an imaginary cylinder.

### HOOK

The undercut on the face of the teeth.

### HOOK ANGLE

The inclination of a concave cutting face, usually specified either as Chordal Hook or Tangential Hook.

**Chordal Hook Angle:** The angle between the chord passing through the root and crest of a thread form at the cutting face, and a radial line through the crest at the cutting edge.

**Tangential Hook Angle:** The angle between a line tangent to a hook cutting face at the cutting edge and a radial line to the same point.

### INTERRUPTED THREAD TAP

A tap having an odd number of lands with alternate teeth along the thread helix removed. In some cases alternate teeth are removed only for a portion of the thread length.

### LAND

The part of the tap body which remains after the flutes are cut, and on which the threads are finally ground. The threaded section between the flutes of a tap.

### LEAD

The axial distance a tap will advance along its axis in one complete turn. On a single start, the lead and the pitch are identical; on a double start, the lead is twice the pitch.

### MAJOR DIAMETER

Commonly known as the "outside diameter." It is the largest diameter of the thread.

### MINOR DIAMETER

Commonly known as the "root diameter." It is the smallest diameter of the thread.

### PERCENT OF THREAD

One-half the difference between the basic major diameter and the actual minor diameter of an internal thread, divided by the basic thread height, expressed as a percentage.

### PITCH

The distance from any point on a screw thread to a corresponding point on the next thread, measured parallel to the axis and on the same side of the axis. The pitch equals one divided by the number of threads per inch.

# DEFINITION OF TERMS APPLYING TO TAPS

## PITCH DIAMETER

On a straight thread, the pitch diameter is the diameter of the imaginary co-axial cylinder...the surface of which would pass through the thread profiles at such points as to make the width of the groove equal to one-half of the basic pitch. On a perfect thread this occurs at the point where the widths of the thread and groove are equal. On a taper thread, the pitch diameter at a given position on the thread axis is the diameter of the pitch cone at that position.

## RAKE

The angular relationship of the straight cutting face of a tooth with respect to a radial line through the crest of the tooth at the cutting edge. Positive rake means that the crest of the cutting face is angularly ahead of the balance of the cutting face of the tooth. Negative rake means that the crest of the cutting face is angularly behind the balance of the cutting face of the tooth. Zero rake means that the cutting face is directly on a radial line.

## RELIEF (or Thread Relief)

The removal of metal from behind the cutting edge to provide clearance and reduce friction between the part being threaded and the threaded land.

## ROOT

The bottom surface joining the sides of two adjacent threads, and is identical with or immediately adjacent to the cylinder or cone from which the thread projects.

## SPIRAL FLUTE

A flute with uniform axial lead in a spiral path around the axis of a tap.

## SPIRAL POINT

The angular fluting in the cutting face of the land at the chamfered end; formed at an angle with respect to the tap axis of opposite hand to that of rotation. Its length is usually greater than the chamfer length and its angle with respect to the tap axis is usually made great enough to direct the chips ahead of the taps cutting action.

## STRAIGHT FLUTE

A flute that forms a cutting edge lying in an axial plane.

## TOLERANCE

In producing a tap to given specifications, tolerance is: (a.) the total permissible variation of a size; (b.) the difference between the limits of size.

# CHAMFERS FOR THREAD CUTTING TAPS

The tap chamfer is the tapering of the threads to distribute cutting action over several teeth. The type of hole to be tapped has much to do with the chamfer style of that tap that's best suited. Some holes go all the way through; some, while not through-holes, are relatively deep; some are quite shallow (a little deeper than diameter). Each of these three kinds of holes - through, deep-bottoming blind, and shallow bottoming - has a tap chamfer best suited to threading requirements.



**TAPER TAPS** - This style, with a **7-10 thread chamfer**, has the longest chamfer of the three to distribute action over the maximum number of teeth; and the taper also acts as a guide in starting the cutting action in the hole.

Taper style taps start the thread square with the workpiece. Taper taps are commonly used in through holes and in materials where a tapered guide is necessary.



**PLUG TAPS** - This style, with a **3-5 thread chamfer**, is most widely used in through holes and where there is sufficient room at the bottom in blind holes.

**SEMI-BOTTOMING TAPS** - This style, with a **2 to 2.5 thread chamfer**, should be used whenever possible in difficult material applications in blind holes, when threads are not required to the bottom of the hole.



**BOTTOMING TAPS** - This style, designed with a **1 to 2 thread chamfer**, is made with just enough chamfer for starting in the hole; as the name implies, it is designed to thread blind holes to the bottom.

**NOTE:** Taper, plug and bottoming taps as a set, in a given size (for example: 1/4-20 NC) are identical as to size, length and vital measurements; the difference is in the chamfered threaded portion at the point. As a rule, such taps when used by hand are furnished in sets of three of a given size...namely, taper, plug and bottoming (and should be used in that order).



### HAND TAP



These standard style taps have straight flutes of a number specified as either standard or optional. Hand taps are for general purpose applications such as production tapping or hand tapping operations. Taper, plug and bottoming styles provide versatility in tough materials, blind and through holes.

### SPIRAL POINT TAP



As to general physical dimensions, spiral point taps are identical with the standard hand tap. However, the spiral point tap has the cutting face of the first few threads cut at a predetermined angle relative to the tap's axis angle to force the evacuation of chips ahead of the cutting action. This feature, plus the excellent shearing action of the flute, make spiral pointed taps ideal for production tapping of through holes. Typically, this type of tap has a shallower flute passage than conventional taps. This gives the spiral point tap more cross-sectional area, which means greater strength, allows higher tapping speeds, and requires less power to drive.

### SPIRAL FLUTED TAP



Regular (or Slow) Spiral



Fast Spiral

These taps, as the name implies, are made with spiral flutes instead of straight flutes. This spiral fluting feature aids in drawing chips out of a hole, or serves to bridge a gap inside the hole such as a keyway or cross-hole. Commonly available in slow spiral (18-30° helix angle) or fast spiral (45-52°). Spiral flute taps are available in left hand style.

### INTERRUPTED THREAD TAP



These taps have an odd number of lands with alternate teeth in the thread helix removed. The removal of every other tooth helps to break the chip and allows a greater supply of lubrication to reach the cutting teeth, reducing the incidence of torn threads. Ideal for tapping non-ferrous metals and low carbon steel; as well as use in titanium and high hardness alloys.

### THREAD FORMING TAP (TRU-FLO™)



These taps are fluteless except as optionally designed with one or more lubrication grooves. The thread form is lobed so there is a finite number of points contacting the work. This tap does not cut, so it is 'chipless', and consequently will not cause a chip problem. The tool forms the thread by extrusion, thus thread size can be closely maintained. The fluteless design allows high quality threads, faster tapping speeds, higher production, and generates no chips which simplifies tapping of blind bottoming holes (threads can be formed the full depth of the hole).

### PIPE TAP



Straight Pipe Tap



Taper Pipe Tap

These taps are for producing standard straight or tapered pipe threads in a wide range of pipe connections. Manufactured with the appropriate design variations to cut specified pipe thread forms.

### COMBINED DRILL & TAP (COST CUTTER™)



This high production tool is specially designed to drill and tap in one pass only. By design, this value-added tool reduces machining operations and subsequent parts handling. The drill end features a split point, and the tool shank and square fit standard tap holders.

### ACME THREAD TAP



Acme screw threads were devised to allow rotary and transversing motion on machines; and are also used in jacks, valves, presses and other mechanisms where heavy loads are encountered. The acme thread is characterized by a 29° included angle. Acme taps typically require specialized engineering and design due to the nature and severity of cut required in producing Acme threads.

**TANDEM ACME TAP**

These taps combine the initial roughing cut with the final finishing cut, in one pass, to achieve an acme screw thread. These taps are economical and enhance production levels by saving on the operation of two tools. Since acme thread pitches are generally coarse relative to diameters, these taps are subjected to heavy chip loads. To achieve a high quality acme thread in a cost-effective manner, roughing and finishing operations are recommended.

**EXTENSION TAPS (incl. Nut & Pulley Taps)**

**Extension Tap** - These taps are made to conventional tap dimensions, except that they have an extended shank in order to tap hard to reach holes. Thread length, shank diameter, and shank square are made to standard specifications listed in Table 302. Extension taps are available in both hand and spiral point styles, and in small shank style.



**Pulley Tap** - The hub portion of pulley parts contain oil cups and set screw holes, most of which cannot be reached with ordinary hand taps. Pulley taps have the same basic thread dimensions as hand taps, but pulley taps differ in that they have a longer shank which is of the same basic major diameter as the threaded portion. When tapping pulley hub holes, the taps are inserted through holes in the rims which are slightly larger than the shanks of the taps. These holes serve as guides or bushings for the taps to assure proper alignment when tapping. Pulley taps can also be used for general tapping in parts where an extra long length is required to reach the holes being tapped.



**Nut Tap** - Nut taps feature a long chamfer which assists in entering the drilled hole, and distributes the cutting action over several teeth. These taps were initially designed for tapping nuts and have a long thread length. The shank diameter is smaller than the tap's minor diameter to allow the accumulation of several nuts after tapping. Nut taps also feature an extended square length.

**THREAD PLUG & RING GAGES**

- Thread Plug Gages - UNC, UNF & UNEF  
Class 2B - 3B, Taperlock & Reversible,  
+ Metric Sizes - Class 6H
- Thread Ring Gages - UNC, UNF, UNEF  
Class 2A-3A  
+ Metric Sizes - Class 6g
- Truncated Thread Setting Plug Gages  
Class 2A-3A  
+ Metric Sizes - Class 6g
- Thread Plug Gages - STI  
Screw Thread Insert
- BSP Plug Gages  
(BSPT, BSPP)
- Taper Pipe Gages - Plugs & Rings  
NPT-L1, L1 & L2 Rings,  
NPTF L1 & L3 Plugs,  
NPTF Crest Check Plugs & Rings

... contact North American Tool for your special gaging requirements.



Thread Plug Gage



Reversible Thread Plug Gage



Thread Ring Gage





**THREAD FORMING TAP ENTRY LENGTHS:** Entry taper length is measured on the full diameter of the thread forming lobes and is the axial distance from the entry diameter position to the theoretical intersection of tap major diameter and entry taper angle.

Whenever entry taper length is specified in terms of number of threads, this length is measured in number of pitches (p).

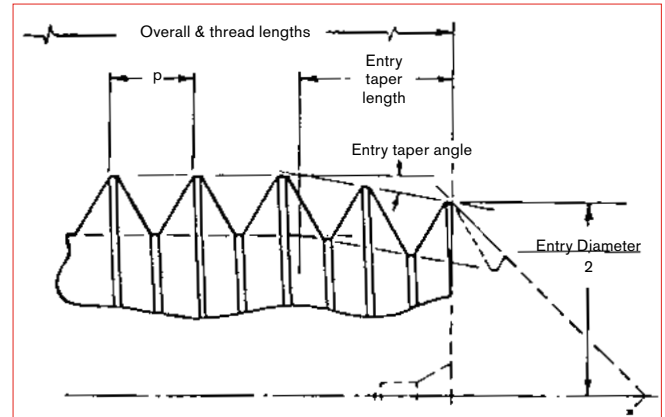
*BOTTOMING LENGTH = 1-1/2 to 2-1/2 PITCHES*

*PLUG LENGTH = 3 to 5 PITCHES*

The chamfer on Tru-Flo BOTTOM taps is approximately 2 threads long and requires a drilled hole depth 3-4 pitches beyond the full thread required. When a controlled maximum chamfer shorter than 2 threads is required, an additional charge will apply. We will not guarantee the performance of taps with the shorter chamfer.

Entry diameter, measured at the thread crest nearest the front of the tap, is an appropriate amount smaller than the diameter of the hole drilled for tapping. See below for tap/drill size formulas, and formulas to determine maximum and minimum drill hole sizes for appropriate percent of thread.

**TAPPING SPEEDS:** TRU-FLO taps operate most efficiently at spindle speeds 1-1/2 to 2 times faster than those recommended for conventional cutting taps, especially



in softer materials and/or with fine pitch TRU-FLO taps. As higher speeds are attained, adequate lubrication is essential for prolonged tap life and thread quality.

**LUBRICATION:** Since it is more important to 'lubricate' the cold-forming tap than to 'cool' the tap, TRU-FLO taps should be used with conventional lubricating cutting oils or EP (extreme pressure) rated oil...soluble oils and similar coolants are not recommended.

**PRE-TAPPED HOLE SIZE:** TRU-FLO cold forming taps require a larger pre-tapped hole size than conventional cutting taps. To insure a properly tapped (cold formed) hole, adhere to the following:

**FORMULA FOR TAP/DRILL SIZES FOR DECIMAL/INCH TRU-FLO TAPS:**

$$\text{HOLE SIZE} = \text{Basic Tap O.D.} - \left( \frac{.0068 \times \% \text{ of Thread}^*}{\text{Threads per Inch}} \right)$$

**For example:**

To determine drill size for a 1/4-20 thread forming tap at 65% of thread:  $.250 - \left( \frac{.0068 \times 65}{20} \right) = .2279$

**FORMULA FOR TAP/DRILL SIZES FOR METRIC TRU-FLO TAPS:**

$$\text{HOLE SIZE (mm)} = \text{Basic Tap O.D.(mm)} - \left( \frac{\% \text{ of Thread} \times \text{mm Pitch}}{147.06} \right)$$

\* Use whole number for % of thread...for 65%, use 65 (not .65).

There is no true method of predicting percent of thread that will be obtained when tapping with forming taps due to the many variables involved. As a starting point, however, 55% for maximum drill size and 75% for minimum drill size can be used as a guide. Any desired percent of thread can be approximated by using drill sizes in between. To determine theoretical maximum and minimum drill sizes (for average operating conditions), see formulas below.

**For UNIFIED INCH Threads:**

**Max. Drill Size** = Basic Major Diameter -  $\frac{3}{8N}$

**Min. Drill Size** = Basic Major Diameter -  $\frac{1}{2N}$

N = T.P.I. (Threads per Inch)

**For 60° Metric Threads:**

**Max. Drill Size** = Basic Major Diameter - 0.375P

**Min. Drill Size** = Basic Major Diameter - 0.5P

P = Pitch

Note: For Basic Major Diameter and Pitch, use millimeter value to obtain drill size in mm.  $\frac{\text{mm Value}}{25.4} = \text{Inch Value}$   
To convert mm to inch value, divide by 25.4:

**TAP RECOMMENDATIONS FOR CLASSES OF THREAD**

Unified and American National Screw Threads

NOMINAL SIZE	T.P.I. NC UNC	T.P.I. NF UNF	RECOMMENDED TAP FOR CLASS OF THREAD				PITCH DIAMETER LIMITS FOR CLASS OF THREAD				
			CLASS 2	CLASS 3	CLASS 2B	CLASS 3B	MIN. ALL CLASSES (BASIC)	MAX. CLASS 2	MAX. CLASS 3	MAX. CLASS 2B	MAX. CLASS 3B
0	—	80	GH1	GH1	GH2	GH1	.0519	.0536	.0532	.0542	.0536
1	64	—	GH1	GH1	GH2	GH1	.0629	.0648	.0643	.0655	.0648
1	—	72	GH1	GH1	GH2	GH1	.0640	.0658	.0653	.0665	.0659
2	56	—	GH1	GH1	GH2	GH1	.0744	.0764	.0759	.0772	.0765
2	—	64	GH1	GH1	GH2	GH1	.0759	.0778	.0773	.0786	.0779
3	48	—	GH1	GH1	GH2	GH1	.0855	.0877	.0871	.0885	.0877
3	—	56	GH1	GH1	GH2	GH1	.0874	.0894	.0889	.0902	.0895
4	40	—	GH2	GH1	GH2	GH2	.0958	.0982	.0975	.0991	.0982
4	—	48	GH1	GH1	GH2	GH1	.0985	.1007	.1001	.1016	.1008
5	40	—	GH2	GH1	GH2	GH2	.1088	.1112	.1105	.1121	.1113
5	—	44	GH1	GH1	GH2	GH1	.1102	.1125	.1118	.1134	.1126
6	32	—	GH2	GH1	GH3	GH2	.1177	.1204	.1196	.1214	.1204
6	—	40	GH2	GH1	GH2	GH2	.1218	.1242	.1235	.1252	.1243
8	32	—	GH2	GH1	GH3	GH2	.1437	.1464	.1456	.1475	.1465
8	—	36	GH2	GH1	GH2	GH2	.1460	.1485	.1478	.1496	.1487
10	24	—	GH3	GH1	GH3	GH3	.1629	.1662	.1653	.1672	.1661
10	—	32	GH2	GH1	GH3	GH2	.1697	.1724	.1716	.1736	.1726
12	24	—	GH3	GH1	GH3	GH3	.1889	.1922	.1913	.1933	.1922
12	—	28	GH3	GH1	GH3	GH3	.1928	.1959	.1950	.1970	.1959
1/4	20	—	GH3	GH2	GH5	GH3	.2175	.2211	.2201	.2224	.2211
1/4	—	28	GH3	GH1	GH4	GH3	.2268	.2299	.2290	.2311	.2300
5/16	18	—	GH3	GH2	GH5	GH3	.2764	.2805	.2794	.2817	.2803
5/16	—	24	GH3	GH1	GH4	GH3	.2854	.2887	.2878	.3401	.2890
3/8	16	—	GH3	GH2	GH5	GH3	.3344	.3389	.3376	.3401	.3387
3/8	—	24	GH3	GH1	GH4	GH3	.3479	.3512	.3503	.3528	.3516
7/16	14	—	GH5	GH3	GH5	GH3	.3911	.3960	.3947	.3972	.3957
7/16	—	20	GH3	GH1	GH5	GH3	.4050	.4086	.4076	.4104	.4091
1/2	13	—	GH5	GH3	GH5	GH3	.4500	.4552	.4537	.4565	.4548
1/2	—	20	GH3	GH1	GH5	GH3	.4675	.4711	.4701	.4731	.4717
9/16	12	—	GH5	GH3	GH5	GH3	.5084	.5140	.5124	.5152	.5135
9/16	—	18	GH3	GH2	GH5	GH3	.5264	.5305	.5294	.5323	.5308
5/8	11	—	GH5	GH3	GH5	GH3	.5660	.5719	.5702	.5732	.5714
5/8	—	18	GH3	GH2	GH5	GH3	.5889	.5930	.5919	.5949	.5934
3/4	10	—	GH5	GH3	GH5	GH3	.6850	.6914	.6895	.6927	.6907
3/4	—	16	GH3	GH2	GH5	GH3	.7094	.7139	.7126	.7159	.7143
7/8	9	—	GH6	GH4	GH6	GH4	.8028	.8098	.8077	.8110	.8089
7/8	—	14	GH4	GH2	GH6	GH4	.8286	.8335	.8322	.8356	.8339
1	8	—	GH6	GH4	GH6	GH4	.9188	.9264	.9242	.9276	.9254
1	—	12	GH4	GH2	GH6	GH4	.9459	.9515	.9499	.9535	.9516
1	—	14*	GH4	GH2	GH6	GH4	.9536	.9585	.9572	.9609	.9590
1 1/8	7	—	GH8	GH4	GH8	GH4	1.0322	1.0407	1.0381	1.0416	1.0393
1 1/8	—	12	GH4	GH4	GH6	GH4	1.0709	1.0765	1.0749	1.0787	1.0768
1 1/4	7	—	GH8	GH4	GH8	GH4	1.1572	1.1657	1.1631	1.1668	1.1644
1 1/4	—	12	GH4	GH4	GH6	GH4	1.1959	1.2015	1.1999	1.2039	1.2019
1 3/8	6	—	GH8	GH4	GH8	GH4	1.2667	1.2768	1.2738	1.2771	1.2745
1 3/8	—	12	GH4	GH4	GH6	GH4	1.3209	1.3265	1.3249	1.3291	1.3270
1 1/2	6	—	GH8	GH4	GH8	GH4	1.3917	1.4018	1.3988	1.4022	1.3996
1 1/2	—	12	GH4	GH4	GH6	GH4	1.4459	1.4515	1.4499	1.4542	1.4522

\*UN

These are general tap recommendations to produce the Class of Thread indicated in average materials when used with reasonable care. However, if the tap specified does not give a satisfactory gage fit in the work, please consult the factory.





**METRIC TAP RECOMMENDATIONS FOR CLASSES OF THREAD (ISO)**

SIZE mm	PITCH mm	RECOMMENDED TAP FOR CLASS OF THREAD		PITCH DIAMETER LIMITS FOR CLASS OF THREAD		
		4H	6H	MINIMUM (BASIC)	MAX. 4H	MAX. 6H
M1.5	0.35	D1	D2	1.273	1.326	1.358
M1.6	0.35	D1	D3	1.373	1.426	1.458
M1.8	0.35	D1	D3	1.573	1.626	1.658
M2	0.45	D1	D2	1.708	1.768	1.803
M2	0.40	D1	D3	1.740	1.796	1.830
M2.2	0.45	D1	D3	1.908	1.968	2.003
M2.3	0.40	D1	D2	2.040	2.096	2.130
M2.5	0.45	D1	D3	2.208	2.268	2.303
M2.6	0.45	D1	D2	2.308	2.368	2.403
M3	0.60	D1	D2	2.610	2.681	2.722
M3	0.50	D1	D3	2.675	2.738	2.775
M3.5	0.60	D1	D4	3.110	3.181	3.222
M4	0.75	D2	D3	3.513	3.588	3.631
M4	0.70	D2	D4	3.545	3.620	3.663
M4.5	0.75	D2	D4	4.013	4.088	4.131
M5	1.00	D2	D3	4.350	4.440	4.490
M5	0.90	D2	D3	4.415	4.501	4.549
M5	0.80	D2	D4	4.480	4.560	4.605
M5.5	0.90	D2	D3	4.915	5.002	5.050
M6	1.00	D3	D5	5.350	5.445	5.500
M6	0.75	D3	D4	5.513	5.598	5.645
M7	1.00	D3	D5	6.350	6.445	6.500
M7	0.75	D2	D4	6.513	6.598	6.645
M8	1.25	D3	D5	7.188	7.288	7.348
M8	1.00	D3	D5	7.350	7.445	7.500
M9	1.25	D3	D5	8.188	8.288	8.348
M9	1.00	D3	D5	8.350	8.445	8.500
M10	1.50	D3	D6	9.026	9.138	9.206
M10	1.25	D3	D5	9.188	9.288	9.348
M10	1.00	D3	D5	9.350	9.445	9.500
M11	1.50	D3	D5	10.026	10.138	10.206
M12	1.75	D3	D6	10.863	10.988	11.063
M12	1.50	D3	D6	11.026	11.144	11.216
M12	1.25	D3	D5	11.188	11.300	11.368
M14	2.00	D3	D7	12.701	12.833	12.913
M14	1.50	D3	D6	13.026	13.144	13.216
M14	1.25	D3	D5	13.188	13.300	13.368

cont.

These are general tap recommendations to produce the Class of Thread indicated in average materials when used with reasonable care. However, if the tap specified does not give a satisfactory gage fit in the work, please consult the factory.

## METRIC TAP RECOMMENDATIONS FOR CLASSES OF THREAD (ISO) cont.

SIZE mm	PITCH mm	RECOMMENDED TAP FOR CLASS OF THREAD		PITCH DIAMETER LIMITS FOR CLASS OF THREAD		
		4H	6H	MINIMUM (BASIC)	MAX. 4H	MAX. 6H
M16	2.00	D4	D7	14.701	14.833	14.913
M16	1.50	D3	D6	15.026	15.144	15.216
M17	1.50	D3	D5	16.026	16.144	16.216
M18	2.50	D4	D7	16.376	16.516	16.600
M18	2.00	D4	D6	16.701	16.833	16.913
M18	1.50	D3	D6	17.026	17.144	17.216
M19	2.50	D4	D6	17.376	17.516	17.600
M20	2.50	D4	D7	18.376	18.516	18.600
M20	2.00	D4	D6	18.701	18.833	18.913
M20	1.50	D3	D6	19.026	19.144	19.216
M22	2.50	D4	D7	20.376	20.516	20.600
M22	2.00	D4	D6	20.701	20.833	20.913
M22	1.50	D3	D6	21.026	21.144	21.216
M24	3.00	D4	D8	22.051	22.221	22.316
M24	2.00	D4	D7	22.701	22.841	22.925
M24	1.50	D3	D5	23.026	23.151	23.226
M25	2.00	D4	D7	23.701	23.841	23.925
M25	1.50	D3	D5	24.026	24.151	24.226
M26	3.00	D5	D8	24.051	24.221	24.316
M27	3.00	D5	D8	25.051	25.221	25.316
M27	2.00	D5	D7	25.701	25.841	25.925
M28	3.00	D5	D8	26.051	26.221	26.316
M28	2.00	D5	D7	26.701	26.841	26.925
M30	3.50	D5	D9	27.727	27.907	28.007
M30	3.00	D5	D8	28.051	28.221	28.316
M30	2.00	D5	D7	28.701	28.841	28.925
M32	3.50	D5	D9	27.727	29.907	30.007
M32	2.00	D5	D7	30.701	30.841	30.925
M33	3.50	D5	D9	30.727	30.907	31.007
M33	3.00	D5	D8	31.051	31.221	31.316
M33	2.00	D5	D7	31.701	31.841	31.925
M34	3.50	D5	D9	31.727	31.907	32.007
M36	4.00	D5	D9	33.402	33.592	33.702
M36	3.00	D5	D8	34.051	34.221	34.316
M36	2.00	D5	D7	34.701	34.841	34.925
M38	4.00	D5	D9	35.402	35.592	35.702
M39	4.00	D6	D9	36.402	36.592	36.702
M39	3.00	D6	D8	37.051	37.221	37.316
M39	2.00	D6	D7	37.701	37.841	37.925

These are general tap recommendations to produce the Class of Thread indicated in average materials when used with reasonable care. However, if the tap specified does not give a satisfactory gage fit in the work, please consult the factory.



TAP/DRILL SIZES

TAP SIZE		CUTTING TAPS		TRU-FLO™ FORMING TAPS	
INCH	METRIC	DRILL SIZE	DECIMAL EQUIVALENT	DRILL SIZE	DECIMAL EQUIVALENT
0-80		3/64	.0469	54	.0550
	M1.6 X 0.35	1.25mm	.0492	1.45mm	.0571
	M1.8 X 0.35	1.45mm	.0571	1.65mm	.0650
1-64		53	.0595	51	.0650
1-72		53	.0595	51	.0650
	M2 X 0.40	1.60mm	.0630	1.80mm	.0709
2-56		50	.0700	5/64	.0781
2-64		50	.0700	47	.0785
	M2.2 X 0.45	1.75mm	.0689	2.00mm	.0787
	M2.5 X 0.45	2.05mm	.0807	2.30mm	.0906
3-48		47	.0785	43	.0890
3-56		46	.0810	2.30mm	.0905
4-40		43	.0890	38	.1015
4-48		42	.0935	2.60mm	.1024
	M3 X 0.50	2.50mm	.0984	7/64	.1094
5-40		38	.1015	33	.1130
5-44		37	.1040	2.90mm	.1142
	M3.5 X 0.60	2.90mm	.1142	3.20mm	.1260
6-32		36	.1065	1/8	.1250
6-40		33	.1130	3.25mm	.1280
	M4 X 0.70	3.30mm	.1299	3.70mm	.1457
8-32		29	.1360	25	.1495
8-36		29	.1360	24	.1520
	M4.5 X 0.75	3.70mm	.1476	4.10mm	.1614
10-24		26	.1470	11/64	.1719
10-32		21	.1590	16	.1770
	M5 X 0.80	4.20mm	.1654	14	.1820
12-24		16	.1770	5mm	.1969
12-28		15	.1800	7	.2010
	M6 X 1.00	5.00mm	.1969	7/32	.2188
1/4-20		7	.2010	1	.2280
1/4-28		3	.2130	15/64	.2340
	M7 X 1.00	6.00mm	.2362	F	.2570
5/16-18		F	.2570	L	.2900
5/16-24		I	.2720	M	.2950
	M8 X 1.25	6.70mm	.2638	7.40mm	.2913
	M8 X 1.0	7.00mm	.2756	19/64	.2969
3/8-16		5/16	.3125	S	.3480
3/8-24		Q	.3320	T	.3580
	M10 X 1.50	8.50mm	.3346	U	.3680
	M10 X 1.25	8.70mm	.3425	9.40mm	.3701
7/16-14		U	.3680	Y	.4040
7/16-20		25/64	.3906	Z	.4130
	M12 X 1.75	10.20mm	.4016	11.20mm	.4409
	M12 X 1.25	10.80mm	.4252	11.50mm	.4528
1/2-13		27/64	.4219	15/32	.4682
1/2-20		29/64	.4531	12.25mm	.4823
	M14 X 2.00	12.00mm	.4224	33/64	.5156
9/16-12		31/64	.4844	17/32	.5312
9/16-18		33/64	.5156	13.50mm	.5315
5/8-11		17/32	.5312	14.75mm	.5807
5/8-18		37/64	.5781	15.25mm	.6004
	M16 X 2.00	14.00mm	.5512	19/32	.5938
	M16 X 1.50	14.50mm	.5906	15.25mm	.6004
	M18 X 2.50	15.50mm	.6102	39/64	.6094
	M18 X 1.50	16.50mm	.6496	17.25mm	.6791

Drill sizes given are the 'closest' drill size.

## TAP/DRILL SIZES cont.

TAP SIZE		CUTTING TAPS		TRU-FLO™ FORMING TAPS	
INCH	METRIC	DRILL SIZE	DECIMAL EQUIVALENT	DRILL SIZE	DECIMAL EQUIVALENT
3/4-10		21/32	.6562	45/64	.7031
3/4-16		11/16	.6875	23/32	.7188
	M20 X 2.50	17.50mm	.6890		
	M20 X 1.50	18.50mm	.7283		
	M22 X 2.50	19.50mm	.7677		
	M22 X 1.50	20.50mm	.8071		
7/8-9		49/64	.7656		
7/8-14		13/16	.8125		
	M24 X 3.00	21.00mm	.8268		
	M24 X 2.00	22.00mm	.8661		
1-8		7/8	.8750		
1-12		59/64	.9219		
	M27 X 3.00	24.00mm	.9449		
	M27 X 2.00	25.00mm	.9843		
1-1/8-7		63/64	.9844		
1-1/8-12		1-3/64	1.0469		
	M30 X 3.50	26.50mm	1.0433		
	M30 X 2.00	28.00mm	1.1024		
1-1/4-7		1-7/64	1.1094		
1-1/4-12		1-11/64	1.1719		
	M33 X 3.50	29.50mm	1.1614		
	M33 X 2.00	31.00mm	1.2205		
1-3/8-6		1-7/32	1.2188		
1-3/8-12		1-19/64	1.2969		
	M36 X 4.00	32.00mm	1.2598		
	M36 X 3.00	33.00mm	1.2992		
1-1/2-6		1-11/32	1.3438		
1-1/2-12		1-27/64	1.4219		
	M39 X 4.00	35.00mm	1.3780		
	M39 X 3.00	36.00mm	1.4173		

## PIPE THREAD DRILLED HOLE SIZES

NOMINAL SIZE	NPT	NPTF	NPSC	NPSM	NPSF	NPSI	BSPT	BSPP
1/16 - 27	D (0.246)	D (0.246)	.250		.250	.250		
1/8 - 27	Q (0.332)	Q (0.332)	.3437	.3593	.3437	.3437		
1/8 - 28							.3281	.3437
1/4 - 18	.4375	.4375	.4375	.4687	.4375	.4375		
1/4 - 19							.4375	.4531
3/8 - 18	.5625	.5781	.5781	.6093	.5781	.5781		
3/8 - 19							.5781	.5937
1/2 - 14	.7031	.7031	.7187	.750	.7187	.7187	.7187	.7343
5/8 - 14								.8125
3/4 - 14	.9062	.9218	.9218	.9646			.9380	.9650
7/8 - 14								1.1093
1 - 11							1.1718	1.1875
1 - 11-1/2	1.1406	1.1562	1.1562	1.2031				
1-1/4 - 11							1.500	1.5468
1-1/4 - 11-1/2	1.4843	1.500	1.500	1.5468				
1-1/2 - 11							1.750	1.7656
1-1/2 - 11-1/2	1.7343	1.7343	1.750	1.7913				
1-3/4 - 11								2.000
2 - 11							2.2187	2.250
2 - 11-1/2	2.2031	2.2187	2.2187	2.2638				

Drill sizes given are the 'closest' drill size.



**FORMULA FOR TAP/DRILL SIZES (INCH)**

**METHOD 1:**

$$\text{Drilled Hole Size (in.)} = \text{Basic Major Dia. Of Thread (in.)} - \frac{.013 \times \% \text{ of Full Thread}^*}{\# \text{ of Threads per Inch (T.P.I.)}$$

\*Use whole numbers for % of thread...for 65% (not .65).

**METHOD 2:**

$$\text{Nominal O.D. - (Dbl. Thread Depth X \% of Full Thread) = Drilled Hole Size}$$

EXAMPLE: To find the hole size for obtaining 75% of thread in a 1/4-20 tapped hole, follow first column down to 20 threads, then across to 75% of thread. This figure (.0485), when subtracted from the .250 diameter, is .2015, which is the required diameter of hole. See equation: .250 - .0485 = .2015

To figure whether or not pitch is too coarse for diameter:  
(Double thread depth) X 3 = x  
x = the smallest diameter possible for that T.P.I.

THREADS PER INCH	DOUBLE THREAD DEPTH	50% THREAD	55% THREAD	60% THREAD	RECOMMENDED RANGE			80% THREAD	85% THREAD
					65% THREAD	70% THREAD	75% THREAD		
6	.21651	.1083	.1192	.1300	.1408	.1517	.1625	.1733	.1842
7	.18558	.0929	.1021	.1114	.1207	.1300	.1393	.1486	.1579
8	.16238	.0813	.0894	.0975	.1056	.1138	.1219	.1300	.1381
9	.14434	.0722	.0794	.0866	.0939	.1011	.1083	.1156	.1228
10	.12990	.0649	.0714	.0779	.0844	.0909	.0974	.1039	.1105
11	.11809	.0590	.0649	.0708	.0767	.0826	.0885	.0944	.1005
12	.10825	.0541	.0595	.0649	.0702	.0755	.0808	.0861	.0921
13	.09992	.0499	.0549	.0599	.0649	.0699	.0749	.0799	.0850
14	.09278	.0464	.0510	.0556	.0602	.0648	.0694	.0740	.0789
16	.08119	.0406	.0446	.0486	.0526	.0566	.0606	.0646	.0691
18	.07217	.0361	.0396	.0431	.0466	.0501	.0536	.0571	.0614
20	.06495	.0325	.0357	.0389	.0421	.0453	.0485	.0517	.0553
24	.05412	.0270	.0298	.0326	.0354	.0382	.0410	.0438	.0460
27	.04811	.0240	.0264	.0288	.0312	.0336	.0360	.0384	.0409
28	.04639	.0232	.0254	.0276	.0298	.0324	.0347	.0370	.0395
30	.04330	.0216	.0238	.0260	.0282	.0304	.0326	.0348	.0368
32	.04059	.0203	.0223	.0243	.0263	.0283	.0303	.0323	.0345
36	.03608	.0180	.0198	.0216	.0234	.0252	.0270	.0288	.0307
40	.03247	.0162	.0178	.0194	.0210	.0226	.0242	.0258	.0276
44	.02952	.0147	.0162	.0177	.0192	.0207	.0222	.0237	.0251
48	.02706	.0135	.0148	.0161	.0174	.0187	.0200	.0213	.0230
56	.02319	.0116	.0127	.0138	.0149	.0160	.0171	.0182	.0197
64	.02029	.0101	.0111	.0121	.0131	.0141	.0151	.0161	.0173
72	.01804	.0090	.0099	.0107	.0115	.0123	.0131	.0139	.0153
80	.01623	.0081	.0089	.0097	.0105	.0113	.0121	.0129	.0138

Figures in table show amount to subtract from O.D. of screw to obtain specific percentages of thread. Select nearest size commercial stock drill.

FORMULA FOR TAP/DRILL SIZES (METRIC)

METHOD 1:

$$\text{Drilled Hole Size (mm)} = \text{Basic Major Dia. Of Thread (mm)} - \frac{\% \text{ of Full Thread}^* \times \text{mm Pitch}}{76.98}$$

\*Use whole numbers for % of thread...for 65%, use 65 (not .65).

METHOD 2:

$$\text{Nominal O.D. - (Dbl. Thread Depth} \times \% \text{ of Full Thread)} = \text{Drilled Hole Size}$$

EXAMPLE: To find the hole size for obtaining 75% of thread in a (M6) 6mm x 1.00 tapped hole, follow first column down to 1.00 threads, then across to 75% of thread. This figure (.9743), when subtracted from 6mm diameter, is 5.0257, which is the required diameter of hole. See equation:  $M6 - (1.2990 \times 75) = (6 - .9743) = 5.0257\text{mm}$

To figure whether or not pitch is too coarse for diameter:  
(Double thread depth) X 3 = x  
x = the smallest diameter possible for that T.P.I.

mm PITCH	DOUBLE THREAD DEPTH	50% THREAD	55% THREAD	60% THREAD	RECOMMENDED RANGE		75% THREAD	80% THREAD	85% THREAD
					65% THREAD	70% THREAD			
4.0	5.1963	2.5982	2.8580	3.1178	3.3776	3.6374	3.8972	4.1570	4.4169
3.50	4.5466	2.2733	2.5006	2.7280	2.9553	3.1826	3.4100	3.6373	3.8646
3.00	3.8969	1.9485	2.1433	2.3381	2.5330	2.7278	2.9227	3.1175	3.3124
2.50	3.2476	1.6238	1.7862	1.9486	2.1109	2.2733	2.4357	2.5981	2.7605
2.00	2.5979	1.2990	1.4288	1.5587	1.6886	1.8185	1.9484	2.0783	2.2082
1.75	2.2733	1.1367	1.2503	1.3640	1.4776	1.5913	1.7050	1.8186	1.9323
1.50	1.9487	.9744	1.0718	1.1692	1.2667	1.3641	1.4615	1.5590	1.6564
1.25	1.6236	.8118	.8930	.9742	1.0553	1.1365	1.2177	1.2989	1.3801
1.00	1.2990	.6495	.7145	.7794	.8444	.9093	.9743	1.0392	1.1042
.90	1.1687	.5844	.6428	.7012	.7597	.8181	.8765	.9350	.9934
.80	1.0394	.5197	.5717	.6236	.6756	.7276	.7796	.8315	.8835
.75	.9743	.4871	.5359	.5846	.6333	.6820	.7307	.7794	.8282
.70	.9093	.4547	.5001	.5456	.5910	.6365	.6820	.7274	.7729
.60	.7793	.3897	.4286	.4676	.5065	.5455	.5845	.6234	.6624
.50	.6421	.3211	.3532	.3853	.4174	.4495	.4816	.5137	.5458
.45	.5847	.2924	.3216	.3508	.3801	.4093	.4385	.4678	.4970
.40	.5197	.2599	.2858	.3118	.3378	.3638	.3898	.4158	.4417
.35	.4547	.2274	.2501	.2728	.2956	.3183	.3410	.3638	.3865
.30	.3896	.1948	.2143	.2338	.2532	.2727	.2922	.3117	.3312
.25	.3246	.1663	.1785	.1948	.2110	.2272	.2434	.2597	.2759

Figures in table show amount to subtract from O.D. of screw to obtain specific percentages of thread. Select nearest size commercial stock drill.



**MATERIAL HOOK OR RAKE ANGLES • SUGGESTED SURFACE TREATMENTS • CUTTING FLUIDS AND CUTTING SPEEDS**  
(INITIAL RECOMMENDATIONS ONLY)

MATERIAL TO BE TAPPED	HOOK OR RAKE ANGLE	SUGGESTED SURFACE TREATMENT **	LUBRICANT/ COOLANT	HSS SPEED=SFM	CARBIDE SPEED=SFM
ALUMINUM (WROUGHT)	12° - 15° HOOK	TiN, TiCN	Soluble or Light Based	90 - 150 SFM	100 - 250 SFM
ALUMINUM DIE CASTING	8° - 10° RAKE	TiCN, TiN, CrN, TiAlN+WC/ C	Soluble Or Lard Oil	65 - 75 SFM	75 - 100 SFM
ALUMINUM BRONZE	0° - 3° RAKE	N, TiN	Mineral Oil W/ Light Oil	20 - 60 SFM	40 - 80 SFM
BAKELITE (HARD PLASTIC)	0° - 3° RAKE	TiCN	Dry Or Air Jet	25 - 40 SFM	25 - 40 SFM
BERYLLIUM COPPER	12° - 14° HOOK	TiAlN+WC/C, CrN, N	Soluble Light Base Oil	50 - 90 SFM	50 - 90 SFM
BRASS	0° - 3° RAKE	None, TiCN	Soluble Light Base Oil	100 - 200 SFM	100 - 200 SFM
BRONZE (FREE-MACHINING)	2° - 6° HOOK	None, TiCN, N	Soluble Light Base Oil	80 - 150 SFM	100 - 200 SFM
CAST BRASS	2° - 5° RAKE	N, TiCN	Soluble Light Base Oil	100 - 200 SFM	125 - 250 SFM
CAST IRON (GRAY)	0° - 3° RAKE	N, TiCN	Dry Or Soluble Oil	20 - 80 SFM	40 - 100 SFM
COPPER	18° HOOK	TiAlN+WC/C, CrN	Soluble Light Base Oil	80 - 150 SFM	100 - 200 SFM
COPPER - NICKEL	12° HOOK	N, TiCN	Soluble Light Base Oil	10 - 20 SFM	20 - 50 SFM
DELTRIN	5° - 8° HOOK	TiAlN+WC/C, TiN, N	Dry, Air Jet, Or Water Soluble	65 - 100 SFM	65 - 100 SFM
DUCTILE IRON	3° - 6° HOOK	N+O, TiN, TiCN	Soluble Or Sulphur Based Oils	30 - 50 SFM	40 - 80 SFM
DURALUMIN	12° - 14° HOOK	TiAlN+WC/C, CrN	Soluble Oil	50 - 90 SFM	50 - 90 SFM
FERRO-TIC	0° - 3° NEG RAKE	None	Anti-Seize Compound	8 - 20 SFM	8 - 20 SFM
FIBERGLASS	0° - 3° RAKE	TiCN	Dry Or Air Jet	25 - 40 SFM	30 - 60 SFM
HASTELLOY	12° - 15° HOOK	CrN	Sulphur Based Oils	8 - 20 SFM	8 - 20 SFM
INCONEL	12° - 15° HOOK	N, CrN	Sulphur Based Oils	8 - 20 SFM	8 - 20 SFM
MAGNESIUM	18° - 20° HOOK (MUST )	CrN	Soluble Light Base Oil	100 - 150 SFM	100 - 150 SFM
MALLEABLE IRON	3° RAKE	N+O, TiN, TiCN	Soluble Or Sulphur Based Oils	30 - 50 SFM	30 - 50 SFM
MANGANESE	0° - 3° RAKE	TiCN	Sulphur Based Oils	8 - 20 SFM	8 - 20 SFM
MANGANESE BRONZE	0° - 3° RAKE	N, TiCN	Soluble Light Base Oil	20 - 60 SFM	40 - 80 SFM
MOLYBDENUM	12° - 14° HOOK	N, TiN, TiCN	Sulphur Based Oils	20 - 45 SFM	30 - 60 SFM
MONEL	12° - 15° HOOK	N, TiCN	Sulphur Based Oils	8 - 20 SFM	15 - 40 SFM
NAVAL BRASS	0° - 3° RAKE	N	Soluble Light Base Oil	100 - 200 SFM	100 - 200 SFM
NAVAL BRONZE	2° - 6° HOOK	None, TiCN	Soluble Light Base Oil	80 - 150 SFM	80 - 150 SFM
NICKEL SILVER	0° - 3° RAKE	N, TiCN	Sulphur Based Oils	20 - 60 SFM	20 - 60 SFM
NICKEL (PURE)	12° - 15° HOOK	N, TiCN	Soluble Light Base Oil	5 - 25 SFM	10 - 40 SFM
NITRALLOY	0° RAKE	N, TiCN	Sulphur Based Oils	8 - 20 SFM	8 - 20 SFM
NITRONIC (*NO GUARANTEE)	12° - 14° POS. RAKE	N, TiN, TiCN	Sulphur Based Oils	8 - 20 SFM	8 - 20 SFM
NYLON	5° - 8° HOOK	N, TiN	Dry, Air Jet Or Water Soluble	65 - 100 SFM	65 - 100 SFM
PLASTICS :					
THERMOPLASTIC (SOFT)	5° - 8° HOOK	N, TiN	Dry, Air Jet Or Water Soluble	65 - 100 SFM	65 - 100 SFM
ABS, DELTRIN, NYLON, PVC, ETC .					
THERMOSETTING (HARD)	0° - 3° RAKE	TiCN	Dry Or Air Jet	25 - 40 SFM	25 - 40 SFM
BAKELITE, LAMINATES, PHENOLIC, POLYESTERS, ETC .					
POWDERED METAL ( Sintered)	0° RAKE	TiCN	Soluble Light Based Oil	25 - 80 SFM	25 - 80 SFM
RUBBER, HARD	0° - 3° RAKE	None	Dry	50 - 200 SFM	50 - 200 SFM
SILICON BRONZE	0° - 3° RAKE	N, TiCN	Soluble Light Base Oil	20 - 60 SFM	20 - 60 SFM
STEEL:					
CARBON STEEL	10° - 12° HOOK	O, N, TiN	Sulphur Based Oil	40 - 90 SFM	50 - 120 SFM
COLD-ROLLED STEEL (1018, ETC.)	10° - 12° HOOK	O, N, TiN, TiAlN	Sulphur Based Oil	40 - 90 SFM	50 - 120 SFM
FORGE D	10° - 12° HOOK	O, N, TiN	Sulphur Based Oil	20 - 50 SFM	30 - 75 SFM
LEADED (12L14, ETC.)	12° HOOK	O, N, TiN	Sulphur Based Oil	40 - 90 SFM	50 - 125 SFM
STAINLESS					
FREE MACHINING	12° - 14° HOOK	N, TiN, TiCN	Sulphur Based Oil	20 - 40 SFM	40 - 180 SFM
PRECIP. HARDENING	12° - 14° HOOK	N, TiN, TiCN	Sulphur Based Oil	8 - 20 SFM	10 - 30 SFM
TOOL	12° - 14° HOOK	N, TiN, TiCN	Sulphur Based Oil	20 - 50 SFM	30 - 65 SFM
TITANIUM	15° - 20° HOOK	O, N, CrN	Sulphur Based Oil	20 - 50 SFM	30 - 65 SFM
TUNGSTEN	5° RAKE	TiN	Sulphur Based Oil	8 - 20 SFM	8 - 20 SFM
TURCITE (SOFT PLASTIC)	5° - 8° HOOK	N, TiN	Dry, Air Jet Or Water Soluble	65 - 100 SFM	65 - 100 SFM
ZAMAK (ZINK DIE CAST)	10° - 12° RAKE	TiCN, TiN, CrN, TiAlN+WC/C	Soluble Light B Ased Oil	50 - 200 SFM	50 - 200 SFM
ZINC	10° - 12° RAKE	TiCN, TiN, CrN, TiAlN+WC/C	Soluble Light B Ased Oil	50 - 200 SFM	50 - 200 SFM

\* If problems are encountered when tapping nitronic (or any other material), please consult North American Tool's Tool Designers.

\*\* See page 127 for definitions of tool coating abbreviations.

The SFM cutting speeds listed are starting SFM recommendations only, and depending on specific tapping conditions, may have to be altered.  
North American Tool Corporation assumes no responsibility or liability of any kind as a result of the above listed SFM recommendations.



TABLE OF SPEEDS FOR TAPS (USE ONLY AS SUGGESTED STARTING R.P.M.)  
MACHINE SCREW AND FRACTIONAL SIZES

TAP SIZE (UNC/ UNF)	TAPER PIPE TAPS (NPT/ NPTF)	SURFACE FEET PER MINUTE (SFM)																	
		5'	10'	15'	20'	25'	30'	40'	50'	60'	70'	80'	90'	100'	110'	120'	130'	140'	150'
		REVOLUTIONS PER MINUTE (RPM)																	
0 (.060)		318	637	955	1273	1592	1910	2546	3183	3820	4456	5093	5729	6366	7003	7639	8276	8913	9549
1 (.073)		273	546	819	1046	1308	1570	2093	2617	3140	3663	4186	4710	5233	5756	6279	6805	7326	7849
2 (.086)		212	424	637	888	1110	1333	1777	2221	2665	3109	3554	3999	4442	4886	5330	5774	6218	6662
3 (.099)		191	382	573	772	964	1157	1543	1929	2315	2701	3086	3472	3858	4244	4629	5015	5401	5787
4 (.112)		174	347	521	682	853	1023	1364	1705	2046	2387	2728	3069	3411	3751	4092	4434	4775	5116
5 (.125)		147	294	441	611	764	917	1222	1528	1833	2139	2445	2750	3056	3361	3667	3973	4278	4584
6 (.138)		136	273	409	553	691	829	1106	1382	1659	1935	2212	2488	2766	3042	3318	3595	3871	4148
8 (.164)		119	239	358	466	583	699	932	1165	1398	1631	1864	2097	2330	2563	2796	3029	3262	3495
10 (.190)		101	201	302	402	502	603	804	1005	1205	1406	1607	1808	2009	2210	2411	2612	2813	3014
12 (.216)		87	174	260	354	442	531	707	884	1061	1238	1415	1592	1769	1945	2122	2300	2476	2653
14 (.242)		79	158	237	316	395	474	631	789	947	1105	1263	1421	1579	1736	1894	2052	2210	2368
1/4		76	153	229	306	382	458	611	764	917	1070	1222	1375	1528	1681	1833	1986	2139	2292
5/16	1/16	62	123	185	245	306	367	489	611	733	856	978	1100	1222	1345	1467	1589	1711	1833
3/8		50	101	151	204	255	305	407	509	611	713	815	917	1019	1120	1222	1324	1426	1528
7/16	1/8	43	87	130	175	219	262	349	437	524	611	698	786	873	960	1048	1135	1222	1310
1/2		38	76	115	153	191	229	305	382	458	535	611	688	764	840	917	993	1070	1146
9/16	1/4	34	68	102	137	172	206	274	342	410	478	547	616	683	752	820	888	952	1020
5/8		32	64	96	122	153	183	244	306	367	428	489	550	611	672	733	794	856	917
11/16	3/8	28	55	83	111	138	167	222	278	333	389	444	500	556	611	667	722	778	833
3/4		35	51	76	102	128	153	203	255	305	357	407	458	509	560	611	662	713	764
7/8	1/2	22	43	65	87	109	131	175	218	262	306	350	392	437	480	524	568	611	655
1"		19	38	57	76	96	115	153	191	230	268	305	344	382	420	458	497	535	573
1 1/8	3/4	17	34	51	68	84	102	136	170	204	238	272	306	340	373	407	441	475	509
1 1/4		15	31	46	61	76	92	122	153	183	214	244	275	305	336	367	397	428	458
1 3/8	1	14	28	42	56	69	83	111	139	167	194	222	250	278	306	333	361	389	417
1 1/2		13	25	38	51	63	76	102	127	153	178	204	229	255	280	305	331	356	382
1 5/8		12	23	35	47	59	71	94	118	141	165	188	212	235	259	282	306	329	353
1 3/4	1 1/4	11	22	33	44	55	65	87	109	131	153	175	196	218	240	262	284	306	327
1 7/8	1 1/2	10	20	30	41	51	61	81	102	122	143	163	183	204	224	244	265	285	306
2"		9	19	29	38	48	57	76	96	115	134	153	172	191	210	229	248	267	287

METRIC SIZES

METRIC TAP SIZE	DEC. EQUIV. SIZE	SURFACE FEET PER MINUTE (SFM)																	
		5'	10'	15'	20'	25'	30'	40'	50'	60'	70'	80'	90'	100'	110'	120'	130'	140'	150'
		REVOLUTIONS PER MINUTE (RPM)																	
M1	.0394	490	979	1469	1959	2449	2938	3918	4897	5877	6856	7836	8815	9795	10774	11754	12733	13713	14692
M2	.0787	242	484	725	967	1209	1451	1934	2418	2901	3385	3868	4352	4835	5319	5803	6286	6770	7253
M3	.1181	162	324	486	647	809	971	1295	1619	1942	2266	2590	2914	3237	3561	3885	4208	4532	4856
M3.5	.1378	138	277	415	554	692	830	1107	1384	1661	1938	2214	2491	2768	3045	3322	3599	3875	4152
M4	.1575	122	243	365	487	608	730	973	1217	1460	1703	1946	2190	2433	2676	2920	3163	3406	3650
M5	.1969	97	194	291	388	485	582	776	970	1163	1357	1551	1745	1939	2133	2327	2521	2715	2909
M6	.2362	81	162	243	324	405	486	647	809	971	1133	1295	1457	1619	1781	1942	2104	2266	2428
M7	.2756	69	138	208	277	346	415	554	692	830	969	1107	1246	1384	1522	1661	1799	1938	2076
M8	.3150	61	121	182	243	303	364	485	606	728	849	970	1091	1213	1334	1455	1577	1698	1819
M10	.3937	48	97	145	194	242	291	388	485	582	679	776	873	970	1067	1163	1260	1357	1454
M12	.4724	40	81	121	162	202	243	324	405	486	567	647	728	809	890	971	1052	1133	1214
M14	.5512	35	69	104	139	173	208	277	347	416	485	555	624	693	763	832	901	971	1040
M16	.6299	30	61	91	121	152	182	243	303	364	424	485	546	606	667	728	788	849	910
M18	.7087	27	54	81	108	135	162	216	269	323	377	431	485	539	593	647	700	754	808
M20	.7874	24	49	73	97	121	146	194	243	291	340	388	437	485	534	582	631	680	728
M22	.8661	22	44	66	88	110	132	176	221	265	309	353	397	441	485	529	573	618	662
M24	.9449	20	40	61	81	101	121	162	202	243	283	323	364	404	445	485	526	566	606
M27	1.0630	18	36	54	72	90	108	144	180	216	252	287	323	359	395	431	467	503	539
M30	1.1811	16	32	49	65	81	97	129	162	194	226	259	291	323	356	388	420	453	485

Factors to be considered when determining tapping speeds:

- Material to be tapped
- Depth of hole
- Length of chamfer on tap
- Pitch of thread
- Percentage of full thread to be cut
- Lubrication
- Machine equipment and rigidity
- Horizontal or vertical tapping

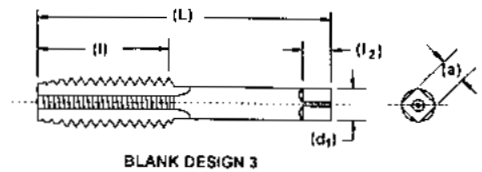
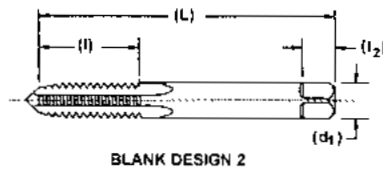
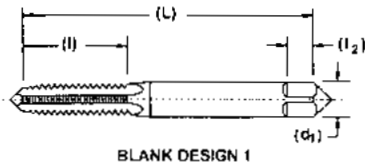
S.F.M./R.P.M. EQUATIONS:

S.F.M. = 0.26 x R.P.M. x Tool Diameter

R.P.M. =  $\frac{3.82 \times \text{S.F.M.}}{\text{TOOL DIAMETER}}$



**STANDARD TAP DIMENSIONS • GROUND THREAD (Ref. USCTI Table 302)**  
**GENERAL DIMENSIONS**



NOMINAL DIAMETER RANGE - INCHES		MACHINE SCREW SIZE NO.	NOMINAL FRACTIONAL DIAMETER INCHES	NOMINAL METRIC DIAMETER MILLIMETERS, (INCHES)	BLANK DESIGN NO.	TAP DIMENSIONS - INCHES				
OVER	TO (INC.)					OVERALL LENGTH L	THREAD LENGTH l	SQUARE LENGTH l <sub>2</sub>	SHANK DIAMETER d <sub>1</sub>	SIZE OF SQUARE a
.052	.065	0 (.0600)		M1.6 (.0630)	1	1.63	.31	.19	.1410	.110
.065	.078	1 (.0730)		M1.8 (.0709)	1	1.69	.38	.19	.1410	.110
.078	.091	2 (.0860)		M2 (.0787), M2.2 (.0866)	1	1.75	.44	.19	.1410	.110
.091	.104	3 (.0990)		M2.5 (.0984)	1	1.81	.50	.19	.1410	.110
.104	.117	4 (.1120)			1	1.88	.56	.19	.1410	.110
.117	.130	5 (.1250)		M3 (.1181)	1	1.94	.63	.19	.1410	.110
.130	.145	6 (.1380)		M3.5 (.1378)	1	2.00	.69	.19	.1410	.110
.145	.171	8 (.1640)		M4 (.1575)	1	2.13	.75	.25	.1680	.131
.171	.197	10 (.1900)		M4.5 (.1772), M5 (.1969)	1	2.38	.88	.25	.1940	.152
.197	.223	12 (.2160)			1	2.38	.94	.28	.2200	.165
.223	.260		1/4 (.2500)	M6 (.2362)	2	2.50	1.00	.31	.2550	.191
.260	.323		5/16 (.3125)	M7 (.2756), M8 (.3150)	2	2.72	1.13	.38	.3180	.238
.323	.395		3/8 (.3750)	M10 (.3937)	2	2.94	1.25	.44	.3810	.286
.395	.448		7/16 (.4375)		3	3.16	1.44	.41	.3230	.242
.448	.510		1/2 (.5000)	M12 (.4724)	3	3.38	1.66	.44	.3670	.275
.510	.573		9/16 (.5625)	M14 (.5512)	3	3.59	1.66	.50	.4290	.322
.573	.635		5/8 (.6250)	M16 (.6299)	3	3.81	1.81	.56	.4800	.360
.635	.709		11/16 (.6875)	M18 (.7087)	3	4.03	1.81	.63	.5420	.406
.709	.760		3/4 (.7500)		3	4.25	2.00	.69	.5900	.442
.760	.823		13/16 (.8125)	M20 (.7874)	3	4.47	2.00	.69	.6520	.489
.823	.885		7/8 (.8750)	M22 (.8661)	3	4.69	2.22	.75	.6970	.523
.885	.948		15/16 (.9375)	M24 (.9449)	3	4.91	2.22	.75	.7600	.570
.948	1.010		1 (1.0000)	M25 (.9843)	3	5.13	2.50	.81	.8000	.600
1.010	1.073		1 - 1/16 (1.0625)	M27 (1.0630)	3	5.13	2.50	.88	.8960	.672
1.073	1.135		1 - 1/8 (1.1250)		3	5.44	2.56	.88	.8960	.672
1.135	1.198		1 - 3/16 (1.1875)	M30 (1.1811)	3	5.44	2.56	1.00	1.0210	.766
1.198	1.260		1 - 1/4 (1.2500)		3	5.75	2.56	1.00	1.0210	.766
1.260	1.323		1 - 5/16 (1.3125)	M33 (1.2992)	3	5.75	2.56	1.06	1.1080	.831
1.323	1.385		1 - 3/8 (1.3750)		3	6.06	3.00	1.06	1.1080	.831
1.385	1.448		1 - 7/16 (1.4375)	M36 (1.4173)	3	6.06	3.00	1.13	1.2330	.925
1.448	1.510		1 - 1/2 (1.5000)		3	6.38	3.00	1.13	1.2330	.925
1.510	1.635		1 - 5/8 (1.6250)	M39 (1.5354)	3	6.69	3.19	1.13	1.3050	.979
1.635	1.760		1 - 3/4 (1.7500)	M42 (1.6535)	3	7.00	3.19	1.25	1.4300	1.072
1.760	1.885		1 - 7/8 (1.8750)		3	7.31	3.56	1.25	1.5190	1.139
1.885	2.010		2 (2.0000)	M48 (1.8898)	3	7.63	3.56	1.38	1.6440	1.233

cont.

# TABLES FOR TAP DIMENSIONS

## STANDARD TAP DIMENSIONS • GROUND THREAD (Ref. USCTI Table 302) cont. GENERAL DIMENSIONS

NOMINAL DIAMETER RANGE - INCHES		MACHINE SCREW SIZE NO.	NOMINAL FRACTIONAL DIAMETER INCHES	NOMINAL METRIC DIAMETER MILLIMETERS, (INCHES)	BLANK DESIGN NO.	TAP DIMENSIONS - INCHES				
OVER	TO (INC.)					OVERALL LENGTH L	THREAD LENGTH l	SQUARE LENGTH l <sub>2</sub>	SHANK DIAMETER d <sub>1</sub>	SIZE OF SQUARE a
2.010	2.135		2 1/8 (2.1250)		3	8.00	3.56	1.38	1.7690	1.327
2.135	2.260		2 1/4 (2.2500)	M56 (2.2047)	3	8.25	3.56	1.44	1.8940	1.420
2.260	2.385		2 3/8 (2.3750)		3	8.50	4.00	1.44	2.0190	1.514
2.385	2.510		2 1/2 (2.5000)		3	8.75	4.00	1.50	2.1000	1.575
2.510	2.635		2 5/8 (2.6250)	M64 (2.5197)	3	8.75	4.00	1.50	2.2250	1.669
2.635	2.760		2 3/4 (2.7500)		3	9.25	4.00	1.56	2.3500	1.762
2.760	2.885		2 7/8 (2.8750)	M72 (2.8346)	3	9.25	4.00	1.56	2.4750	1.856
2.885	3.010		3 (3.0000)		3	9.75	4.56	1.63	2.5430	1.907
3.010	3.135		3 1/8 (3.1250)		3	9.75	4.56	1.63	2.6680	2.001
3.135	3.260		3 1/4 (3.2500)	M80 (3.1496)	3	10.00	4.56	1.75	2.7930	2.095
3.260	3.385		3 3/8 (3.3750)		3	10.00	4.56	1.75	2.8830	2.162
3.385	3.510		3 1/2 (3.5000)		3	10.25	4.94	2.00	3.0080	2.256
3.510	3.635		3 5/8 (3.6250)	M90 (3.5433)	3	10.25	4.94	2.00	3.1330	2.350
3.635	3.760		3 3/4 (3.7500)		3	10.50	5.31	2.13	3.2170	2.413
3.760	3.885		3 7/8 (3.8750)		3	10.50	5.31	2.13	3.3420	2.506
3.885	4.010		4 (4.0000)	M100 (3.9370)	3	10.75	5.31	2.25	3.4670	2.600

### SPECIAL TAPS

Unless otherwise specified:

Special taps over 1.010" to 1.510" diameter inclusive, having 14 or more threads per inch or 1.75 millimeter pitch and finer, and sizes over 1.510" diameter with 10 or more threads per inch or 2.5 millimeter pitch and finer, are made to general dimensions shown in Table 303.

Special tap thread limits are determined by using the formulas shown in Table 331 for Unified Inch Screw Threads and Table 341 for Metric M-Profile Screw Threads.

### NOTES

Tap sizes .395" and smaller have an external center on the threadend (may be removed on bottoming taps). Sizes .223" and smaller have an external center on the shank end. Sizes .224" thru .395" have truncated partial cone centers on the shank end (length of cone approx. 1/4 of diameter of shank). Sizes over .395" have internal centers on both the thread and shank ends.

For standard thread limits and tolerances for Unified Inch Screw Threads see table 327 and for Metric Threads see Table 337.

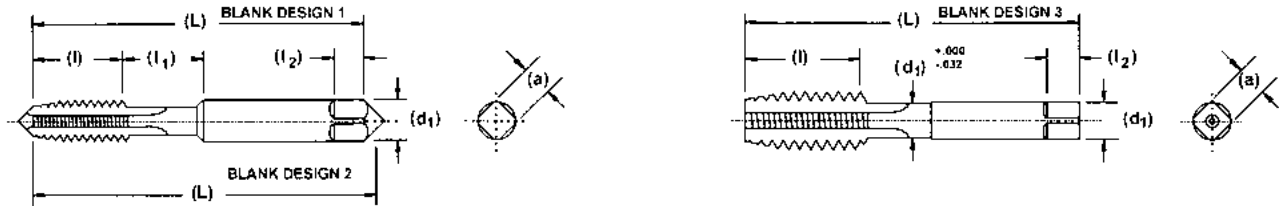
For eccentricity tolerances of tap elements see Table 317.

### TOLERANCES

ELEMENT	NOMINAL DIAMETER RANGE IN INCHES		DIRECTION	TOLERANCE (INCHES)
	OVER	TO (INC.)		
Length Overall - L	.0520	1.0100	Plus or Minus	.031
	1.0100	4.0100	Plus or Minus	.063
Length of Thread - l	.0520	.2230	Plus or Minus	.047
	.2230	.5100	Plus or Minus	.063
	.5100	1.5100	Plus or Minus	.094
	1.5100	4.0100	Plus or Minus	.125
Length of square - l <sub>2</sub>	.0520	1.0100	Plus or Minus	.031
	1.0100	4.0100	Plus or Minus	.063
Diameter of shank - d <sub>1</sub>	.0520	.2230	Minus	.0015
	.2230	.6350	Minus	.0015
	.6350	1.0100	Minus	.0020
	1.0100	1.5100	Minus	.0020
	1.5100	2.0100	Minus	.0030
	2.0100	4.0100	Minus	.0030
Size of square - a	.0520	.5100	Minus	.004
	.5100	1.0100	Minus	.006
	1.0100	2.0100	Minus	.008
	2.0100	4.0100	Minus	.010



**OPTIONAL NECK AND OPTIONAL SHORTENED THREAD LENGTH TAP DIMENSIONS, GROUND THREAD (Ref. USCTI Table 302-A)**  
GENERAL DIMENSIONS



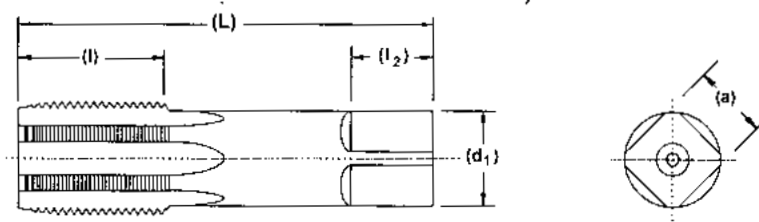
NOMINAL DIAMETER RANGE - INCHES		MACHINE SCREW SIZE NO.	NOMINAL FRACTIONAL DIAMETER INCHES	NOMINAL METRIC DIAMETER MILLIMETERS, (INCHES)	BLANK DESIGN NO.	TAP DIMENSIONS - INCHES					
OVER	TO (INCL.)					OVERALL LENGTH L	THREAD LENGTH l	NECK LENGTH l <sub>1</sub>	SQUARE LENGTH l <sub>2</sub>	SHANK DIAMETER d <sub>1</sub>	SIZE OF SQUARE a
.104	.117	4 (.1120)			1	1.88	.31	.25	.19	.1410	.110
.117	.130	5 (.1250)		M3 (.1181)	1	1.94	.31	.31	.19	.1410	.110
.130	.145	6 (.1380)		M3.5 (.1378)	1	2.00	.38	.31	.19	.1410	.110
.145	.171	8 (.1640)		M4 (.1575)	1	2.13	.38	.38	.25	.1680	.131
.171	.197	10 (.1900)		M4.5 (.1772), M5 (.1969)	1	2.38	.50	.38	.25	.1940	.152
.197	.223	12 (.2160)			1	2.38	.50	.44	.28	.2200	.165
.223	.260		1/4 (.2500)	M6 (.2362)	2	2.50	.63	.38	.31	.2550	.191
.260	.323		5/16 (.3125)	M7 (.2756), M8 (.3150)	2	2.72	.69	.44	.38	.3180	.238
.323	.395		3/8 (.3750)	M10 (.3937)	2	2.94	.75	.50	.44	.3810	.286
.395	.448		7/16 (.4375)		3	3.16	.88	-	.41	.3230	.242
.448	.510		1/2 (.5000)	M12 (.4724)	3	3.38	.94	-	.44	.3670	.275
.510	.573		9/16 (.5625)	M14 (.5512)	3	3.59	1.00	-	.50	.4290	.322
.573	.635		5/8 (.6250)	M16 (.6299)	3	3.81	1.09	-	.56	.4800	.360
.635	.709		11/16 (.6875)	M18 (.7087)	3	4.03	1.09	-	.63	.5420	.406
.709	.760		3/4 (.7500)		3	4.25	1.22	-	.69	.5900	.442
.760	.823		13/16 (.8125)	M20 (.7874)	3	4.47	1.22	-	.69	.6520	.489
.823	.885		7/8 (.8750)	M22 (.8661)	3	4.69	1.34	-	.75	.6970	.523
.885	.948		15/16 (.9375)	M24 (.9449)	3	4.91	1.34	-	.75	.7600	.570
.948	1.010		1 (1.0000)	M25 (.9843)	3	5.13	1.50	-	.81	.8000	.600

**NOTES**

1. Thread Length "l" is based on a length of 12 pitches of the UNC thread series.
2. Thread Length "l" is a minimum value and has no tolerance.
3. When Thread Length "l" is added to Neck Length "l<sub>1</sub>" the total shall be no less than the minimum Table 302 Thread Length "l".
4. Unless otherwise specified, all tolerances are in accordance with Table 302.
5. For eccentricity tolerances, see Table 317.

# TABLES FOR TAP DIMENSIONS

## SPECIAL FINE PITCH TAPS, SHORT SERIES, GROUND THREAD (Ref. USCTI Table 303) GENERAL DIMENSIONS



Unless otherwise specified, special taps 1.010" to 1.510" diameter inclusive, having 14 or more threads per inch or 1.75 millimeter pitch and finer, and sizes over 1.510" diameter with 10 or more threads per inch, or 2.5 millimeter pitch and finer, will be made to the general dimensions shown below:

NOMINAL DIAMETER RANGE - INCHES		NOMINAL FRACTIONAL DIAMETER INCHES	NOMINAL METRIC DIAMETER MILLIMETERS	TAP DIMENSIONS - INCHES				
OVER	TO (INCL.)			OVERALL LENGTH L	THREAD LENGTH l	SQUARE LENGTH l <sub>2</sub>	SHANK DIAMETER d <sub>1</sub>	SIZE OF SQUARE a
1.010	1.073	1 1/16	M27	4.00	1.50	.88	.8960	.672
1.073	1.135	1 1/8		4.00	1.50	.88	.8960	.672
1.135	1.198	1 3/16	M30	4.00	1.50	1.00	1.0210	.766
1.198	1.260	1 1/4		4.00	1.50	1.00	1.0210	.766
1.260	1.323	1 5/16	M33	4.00	1.50	1.00	1.1080	.831
1.323	1.385	1 3/8		4.00	1.50	1.00	1.1080	.831
1.385	1.448	1 7/16	M36	4.00	1.50	1.00	1.2330	.925
1.448	1.510	1 1/2		4.00	1.50	1.00	1.2330	.925
1.510	1.635	1 5/8	M39	5.00	2.00	1.13	1.3050	.979
1.635	1.760	1 3/4	M42	5.00	2.00	1.25	1.4300	1.072
1.760	1.885	1 7/8		5.00	2.00	1.25	1.5190	1.139
1.885	2.010	2	M48	5.00	2.00	1.38	1.6440	1.233
2.010	2.135	2 1/8		5.25	2.00	1.38	1.7690	1.327
2.135	2.260	2 1/4	M56	5.25	2.00	1.44	1.8940	1.420
2.260	2.385	2 3/8		5.25	2.00	1.44	2.0190	1.514
2.385	2.510	2 1/2		5.25	2.00	1.50	2.1000	1.575
2.510	2.635	2 5/8	M64	5.50	2.00	1.50	2.1000	1.575
2.635	2.760	2 3/4		5.50	2.00	1.50	2.1000	1.575
2.760	2.885	2 7/8	M72	5.50	2.00	1.50	2.1000	1.575
2.885	3.010	3		5.50	2.00	1.50	2.1000	1.575
3.010	3.135	3 1/8		5.75	2.00	1.50	2.1000	1.575
3.135	3.260	3 1/4	M80	5.75	2.00	1.50	2.1000	1.575
3.260	3.385	3 3/8		5.75	2.00	1.50	2.1000	1.575
3.385	3.510	3 1/2		5.75	2.00	1.50	2.1000	1.575
3.510	3.635	3 5/8	M90	6.00	2.00	1.75	2.1000	1.575
3.635	3.760	3 3/4		6.00	2.00	1.75	2.1000	1.575
3.760	3.885	3 7/8		6.00	2.00	1.75	2.1000	1.575
3.885	4.010	4	M100	6.00	2.00	1.75	2.1000	1.575

### NOTES

For tolerances see Table 302.

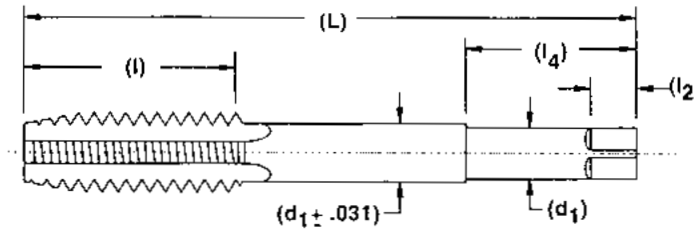
For standard thread limits and tolerances for Unified Inch Screw Threads see Table 327A.

For standard thread limits and tolerances for Metric Threads see Tables 337 and 341.

For eccentricity tolerances of tap elements see Table 317.



**SPECIAL EXTENSION TAPS, GROUND THREAD (REF. USCTI TABLE 303-A)**



Unless otherwise specified, special extension taps will be furnished with dimensions and tolerances as shown for Machine Screw and Fractional taps in Tables 302 and 303, and for Pipe taps in Table 311.

**Exceptions:**

1. Types of centers are optional with manufacturer.
2. Tolerances on shank diameter  $d_1$  for  $l_4$  length as shown in the following table.
3. Shank eccentricity tolerance in Table 317 applies only to the  $l_4$  length shown in the following table.
4. Length of Close Tolerance Shank,  $(L_4)$  is minimum.

NOMINAL TAP SIZE		l THREAD LENGTH	d <sub>1</sub> SHANK DIAMETER	l <sub>2</sub> SQUARE LENGTH	SQUARE SIZE	l <sub>4</sub> GROUND SHANK LENGTH
FRACTIONAL	MACHINE SCREW					
	6	0.69	0.1410	0.19	.110	1.13
	8	0.75	0.1680	0.25	.131	1.25
	10 - 12	0.88	0.1940	0.25	.152	1.38
1/4	14	1.00	0.2550	0.31	.191	1.50
1/4*		1.00	0.1850	0.25	.138	Full Length
5/16		1.13	0.3180	0.38	.238	1.56
5/16*		1.13	0.2400	0.28	.180	Full Length
3/8		1.25	0.3810	0.44	.286	1.63
3/8*		1.25	0.2750	0.38	.206	Full Length
7/16		1.44	0.3230	0.41	.242	1.69
1/2		1.66	0.3670	0.44	.275	1.69
9/16		1.66	0.4290	0.50	.322	1.88
5/8		1.81	0.4800	0.56	.360	2.00
3/4		2.00	0.5900	0.69	.442	2.25
7/8		2.22	0.6970	0.75	.523	2.50
1"		2.50	0.8000	0.81	.600	2.63
1-1/8		2.56	0.8960	0.88	.672	2.75
1-1/4		2.56	1.0210	1.00	.766	2.88
1-3/8		3.00	1.1080	1.06	.831	3.00
1-1/2		3.00	1.2330	1.13	.925	3.00

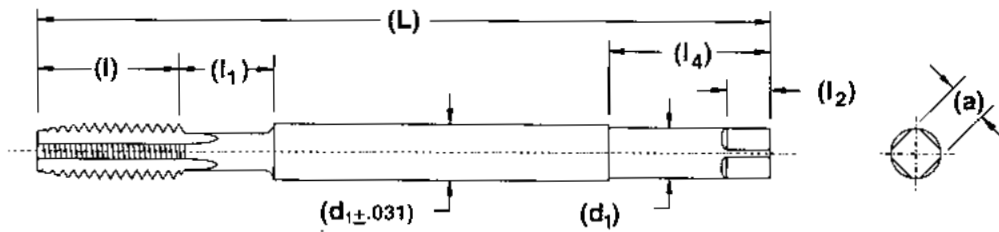
\* Small Shank

**TOLERANCES FOR SHANK DIAMETER, d<sub>1</sub> AND l<sub>4</sub> LENGTH**

SIZE RANGE		DIRECTION	TOLERANCES
FRACTIONAL	MACHINE SCREW		
1/4 to 5/8 incl.	0 -14 incl.	Minus	.003
11/16 to 1-1/2 incl.		Minus	.004

# TABLES FOR TAP DIMENSIONS

## PULLEY TAP DIMENSIONS • GROUND THREAD (REF. USCTI TABLE 310) GENERAL DIMENSIONS



NOMINAL FRACTION DIAMETER INCHES	TAP DIMENSIONS - INCHES						
	OVERALL LENGTH L	THREAD LENGTH l	NECK LENGTH l <sub>1</sub>	SQUARE LENGTH l <sub>2</sub>	LENGTH OF SHANK CLOSE TOL. SECTION l <sub>4</sub>	SHANK DIAMETER d <sub>1</sub>	SIZE OF SQUARE a
1/4 (.2500)	6,8	1.00	.38	.31	1.50	.2550	.191
5/16 (.3125)	6,8	1.13	.38	.38	1.56	.3180	.238
3/8 (.3750)	6,8,10	1.25	.38	.44	1.63	.3810	.286
7/16 (.4375)	6,8	1.44	.44	.50	1.69	.4440	.333
1/2 (.5000)	6,8,10,12	1.66	.50	.56	1.69	.5070	.380
5/8 (.6250)	6,8,10,12	1.81	.63	.69	2.00	.6330	.475
3/4 (.7500)	10,12	2.00	.75	.75	2.25	.7590	.569

### TOLERANCES

ELEMENT	SIZE RANGE	DIRECTION	TOLERANCE
Overall Length - L	1/4 to 3/4 included	Plus or Minus	.063
Thread Length - l	1/4 to 3/4 included	Plus or Minus	.063
Neck Length - l <sub>1</sub>	1/4 to 3/4 included	See Note - 1	See Note - 1
Square Length - l <sub>2</sub>	1/4 to 3/4 included	Plus or Minus	.031
Length of Shank (close tol.) l <sub>4</sub>	1/4 to 3/4 included	See Note - 2	See Note - 2
Size of Diameter - d <sub>1</sub>	1/4 to 3/4 included	Minus	.0050
Size of Square - a	1/4 to 1/2 included	Minus	.004
	5/8 to 3/4 included	Minus	.006

### NOTES

1. l<sub>1</sub>, (Neck Length); neck and its length is optional with manufacturer.
2. l<sub>4</sub>, (Length of Close Tolerance Shank) is minimum length which is held to eccentricity tolerances per Table 317.

### GENERAL NOTES

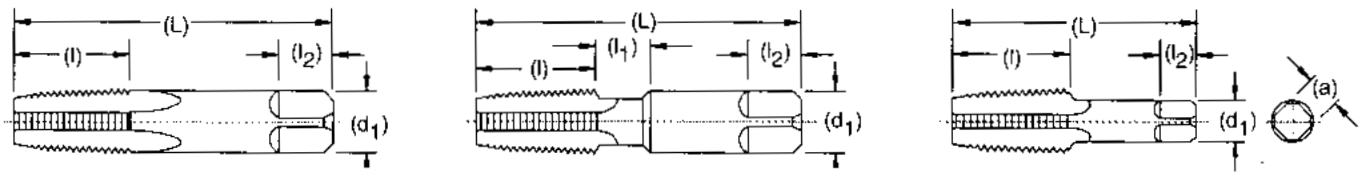
- a. These taps have an internal center in the thread end.
- b. These taps are made to the H3 limits shown in Table 327.
- c. For eccentricity tolerances of taps elements see Table 317.
- d. d<sub>1</sub>, (Shank diameter) is approximately the same as the maximum major diameter for that size.
- e. a, (Size of Square) is equal to .75 X d<sub>1</sub> to the nearest .001 inch.





**STANDARD PIPE TAP DIMENSIONS • STRAIGHT AND TAPER, GROUND THREAD (REF. USCTI TABLE 311)**

**GENERAL DIMENSIONS**



NOMINAL SIZE INCHES	LENGTH OVERALL L	LENGTH OF THREAD l	LENGTH OF SQUARE l <sub>2</sub>	DIA. OF SHANK d <sub>1</sub>	SIZE OF SQUARE a	LENGTH OPTIONAL NECK l <sub>1</sub>
1/16	2.13	.69	.38	.3125	.234	.375
1/8*	2.13	.75	.38	.3125	.234	...
1/8	2.13	.75	.38	.4375	.328	.375
1/4	2.44	1.06	.44	.5625	.421	.375
3/8	2.56	1.06	.50	.7000	.531	.375
1/2	3.13	1.38	.63	.6875	.515	...
3/4	3.25	1.38	.69	.9063	.679	...
1"	3.75	1.75	.81	1.1250	.843	...
1 - 1/4	4.00	1.75	.94	1.3125	.984	...
1 - 1/2	4.25	1.75	1.00	1.5000	1.125	...
2"	4.50	1.75	1.13	1.8750	1.406	...
2 - 1/2	5.50	2.56	1.25	2.2500	1.687	...
3"	6.00	2.63	1.38	2.6250	1.968	...
3 - 1/2	6.50	2.69	1.50	2.8125	2.108	...
4"	6.75	2.75	1.56	3.0000	2.250	...

\* Small Shank

**TOLERANCES**

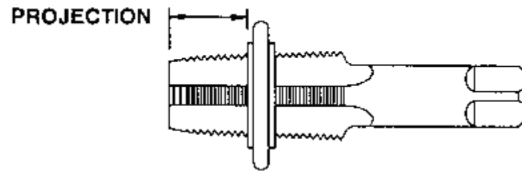
ELEMENT	RANGE	DIRECTION	TOLERANCE
Length Overall - L	1/16 to 3/4 inc.	Plus or Minus	.031
	1" to 4" inc.	Plus or Minus	.063
Length of Thread - l	1/16 to 3/4 inc.	Plus or Minus	.063
	1" to 1 - 1/4 inc.	Plus or Minus	.094
	1 - 1/2 to 4"	Plus or Minus	.125
Length of Square - l <sub>2</sub>	1/16 to 3/4 inc.	Plus or Minus	.031
	1" to 4" inc.	Plus or Minus	.063
Diameter of Shank - d <sub>1</sub>	1/16 to 1/8	Minus	.0015
	1/4 to 1" inc.	Minus	.0020
	1 - 1/4 to 4" inc.	Minus	.0030
Size of Square - a	1/16 to 1/8	Minus	.004
	1/4 to 3/4 inc.	Minus	.006
	1" to 4" inc.	Minus	.008

**NOTE**

For thread limits and tolerances see USCTI Tables 335, 335A and 338.  
For eccentricity tolerances of taps see Table 317.

# TABLES FOR TAP DIMENSIONS

## TAPER PIPE TAP, THREAD LIMITS, GROUND THREAD (REF. USCTI TABLE 338)



- American National Standard Taper Pipe Thread Form (NPT)
- Aeronautical National Taper Pipe Thread Form (ANPT)
- Dryseal American National Standard Taper Pipe Thread Form (NPTF)

THREAD TAP LIMITS						L <sub>1</sub> LENGTH
NOMINAL SIZE INCHES	THREADS PER INCH	PROJECTION* INCHES	PROJECTION TOLERANCE + OR -	TAPER PER FOOT LIMITS		
				MINIMUM	MAXIMUM	
1/16	27	.312	.063	.719	.781	.160
1/8	27	.312	.063	.719	.781	.1615
1/4	18	.459	.063	.719	.781	.2278
3/8	18	.454	.063	.719	.781	.240
1/2	14	.579	.063	.719	.781	.320
3/4	14	.565	.063	.719	.781	.339
1"	11-1/2	.678	.094	.719	.781	.400
1-1/4	11-1/2	.686	.094	.719	.781	.420
1-1/2	11-1/2	.699	.094	.719	.781	.420
2"	11-1/2	.667	.094	.719	.781	.436
2-1/2	8	.925	.094	.734	.781	.682
3"	8	.925	.094	.734	.781	.766
3-1/2	8	.938	.125	.734	.781	.821
4	8	.950	.125	.734	.781	.844

### NOTES

- \* Distance small end of tap projects through L<sub>1</sub> Taper Thread Ring Gage.  
See page 114 for pipe tap drill sizes.

### LEAD TOLERANCE

A maximum lead deviation of plus or minus .0005" within any two threads not farther than 1" is permitted.



# TAP DIMENSIONS AND SURFACE TREATMENT RECOMMENDATIONS

## ECCENTRICITY TOLERANCES OF TAP ELEMENTS WHEN TESTED ON DEAD CENTERS (REF. USCTI TABLE 317) APPLICABLE TO TABLES 302, 303, 303A, AND 311

ELEMENT	RANGE			GROUND THREAD	
	INCH & MACH. SCREW	PIPE	METRIC	ECCENTRICITY	t.i.v.*
Square (at central point)	#0 - 1/2"	1/16 - 1/8"	M1.6 - M12	.0030	.0060
	Over 1/2" thru 4"	1/4 - 4"	Over M12 thru M100	.0040	.0080
Shank	#0 - 5/16"	1/16"	M1.6 - M8	.0005	.0010
	Over 5/16" thru 4"	1/8 - 4"	Over M8 thru M100	.0008	.0016
Major Diameter	#0 - 5/16"	1/16"	M1.6 - M8	.0005	.0010
	Over 5/16" thru 4"	1/8 - 4"	Over M8 thru M100	.0008	.0016
Pitch Diameter (at first full thread)	#0 - 1/2"	1/16"	M1.6 - M8	.0005	.0010
	Over 1/2" thru 4"	1/8 - 4"	Over M8 thru M100	.0008	.0016
Chamfer**	#0 - 1/2"	1/16 - 1/8"	M1.6 - M12	.0010	.0020
	Over 1/2" thru 4"	1/4 - 4"	Over M12 thru M100	.0015	.0030

\* t.i.v. = Total indicator variation. Figures are given for both eccentricity and total indicator variation to avoid misunderstanding.

\*\* Chamfer should preferably be inspected by light projection to avoid errors due to indicator contact points dropping into the thread grooves.

### SURFACE TREATMENT ABBREVIATIONS

SEE PAGE 117 FOR SURFACE TREATMENT RECOMMENDATIONS

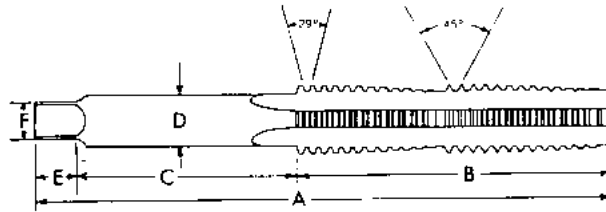
CrN: Chromium Nitride	TiAlN: Titanium Aluminum Nitride
N: Nitride	TiCN: Titanium Carbonitride
N + O: Nitride + Oxide	TiN: Titanium Nitride
O: Steam Oxide	DLC: Diamond-like Carbon
AlCrN: Aluminum Chromium Nitride	TiAlN + WC/C: Titanium Aluminum Nitride + Tungsten Carbide/Carbon



Surface treatments and coatings allow improved tooling performance. For more information on surface treatments, contact Customer Service.

# TABLES FOR TAP DIMENSIONS

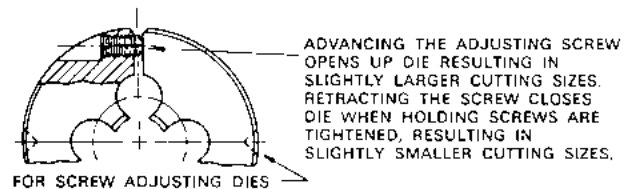
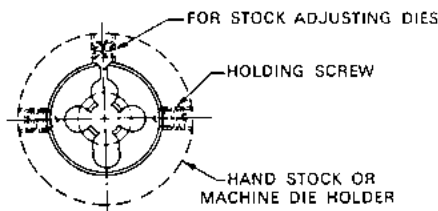
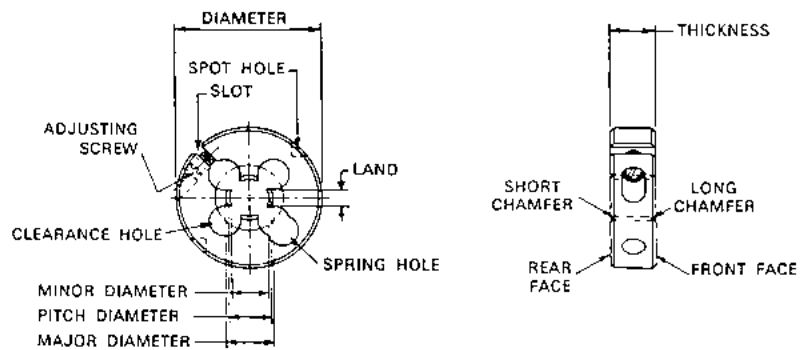
## TANDEM ACME TAP DIMENSIONS



SIZE & PITCH	A OVERALL LENGTH	B LENGTH THREAD END	ROUND SHANK		SQUARE		MAXIMUM DEPTH OF NUT	
			C LENGTH	D DIA.	E LENGTH	F ACROSS FLATS	BRONZE & STEEL	BRASS & CAST IRON
1/4 -16	3"	1 3/4	1"	.185	1/4	.138	1/2	3/4
5/16 -14	3 13/32	1 7/8	1 1/4	.220	9/32	.165	5/8	7/8
3/8 -12	4 1/16	2 1/8	1 5/8	.255	5/16	.191	5/8	1"
1/2 -10	5"	2 9/16	2"	.367	7/16	.275	1"	1 1/2
5/8 -8	6 1/4	3 3/16	2 1/2	.480	9/16	.360	1 1/4	1 7/8
3/4 -6	7 15/16	4 5/16	3"	.542	5/8	.406	1 1/2	2 1/4
3/4 -8	7 15/16	4 5/16	3"	.542	5/8	.406	1 1/2	2 1/4
7/8 -6	8 5/8	4 3/8	3 1/2	.697	3/4	.523	1 3/4	2 5/8
1" -5	10 1/8	5 1/4	4"	.697	3/4	.523	2"	3"
1 1/8 -5	10 3/4	5 1/4	4 1/2	.800	13/16	.600	2 1/4	3 3/8
1 1/4 -5	11 1/8	5 1/4	4 3/4	.896	7/8	.672	2 1/2	3 3/4
1 3/8 -4	12 1/4	5 7/8	5 1/8	1.108	1 1/4	.831	2 3/4	4 1/8
1 1/2 -4	12 5/8	5 7/8	5 1/2	1.233	1 1/4	.925	3"	4 1/2
1 3/4 -4	13 3/8	5 7/8	6 1/4	1.430	1 1/4	1.072	3 1/2	5"
2" -4	14 7/8	6 1/2	7	1.644	1 3/8	1.233	4"	6"

## ROUND ADJUSTABLE DIES TECHNICAL DATA DIE THICKNESS CHART

O.D.(INCH)	O.D.(MM)	THICKNESS
13/16	20.6 mm	1/4
1"	25.4 mm	3/8
1-1/2	38.1 mm	1/2
2"	50.8 mm	5/8
2-1/2	63.5 mm	3/4
3" (10 pitch & coarser)	76.2 mm	1"
3" (11 pitch & finer)	76.2 mm	3/4



## GENERAL INFORMATION

We consider the relationship between North American Tool Corporation and the Industrial Distributor the most important part of our future. Together, as “Value Added Partners”, we are focused on satisfying the cutting tool requirements of your customers through:

- Outstanding Customer Service
- Quality Tools
- Shipped On Time

### SALES & SERVICE POLICY:

North American Tool Corporation will sell only through recognized Industrial Distributors. We will accept direct emergency orders from customers when they agree to send confirming orders to a North American Tool Corporation distributor in their trading area.

### TRANSPORTATION & SHIPPING INFORMATION:

There are no additional charges for drop shipments. All international orders, unless otherwise specified, will be shipped via International Express Mail.

North American Tool Corporation will not make shipping promises we cannot keep. This means no expediting calls and delayed shipments — at a great loss of time and money to all of us. **Standard industry practice is to over or under ship by 10% on quantities of 6 or more for full special tools unless otherwise specified at the time of the order. QUOTED prices on full special tools also are based on this industry practice, unless exact quantity pricing is requested.** Please advise us of any discrepancy in quantity or pricing within 10 days, so that we can correct it promptly.

### RETURNED GOODS:

We guarantee all of our products to be of the finest quality; manufactured to standard industry tolerances and dimensions, and consistent with your customer's design criteria and application specifications. Should the need arise to return any cutting tools, please contact us for authorization. A restocking charge may apply.

### HOLD FOR RELEASE & BLANKET ORDERS:

It is our desire to help our customers with control of costly inventory. We will gladly accept orders for timed release shipments over a reasonable period to satisfy your “just in time” needs. We do consider these firm orders, subject to shipment of all remaining tools at the end of the contract period.

### TRIAL TOOLS:

Our many years of experience clearly show that test or trial tool orders without a purchase order are rarely followed to final test conclusion. We can both follow results if a purchase order is issued at current price based upon the quantity being tested. If the test is successful, and additional tools are ordered, they will be priced at the larger quantity and the test tools will be credited to that order. Should the test fail, or performance not be as promised, based upon designs and recommendations made by North American Tool Corporation, we will issue credit on the original test tool order.

**You can qualify for up to \$200.00 in a test tools credit if you provide us with a test report and video of your tooling application. You must give permission for North American Tool to use video and/or test report on our website or social media platforms. Contact us for details.**

### CREDIT CARD ORDERS:

We accept the following credit cards:



## LIMITED WARRANTY

North American Tool Corporation, hereafter denoted as NATC, warrants its products to be free from defects in workmanship and material at the time of manufacture. Any products that are found to be defective in workmanship or material, will be repaired, replaced, or credit issued at the option of NATC, to the user of our products. Determination as to defective product rests solely with NATC. NATC shall have no obligation to repair or replace products damaged by misuse, improper operating conditions, products altered or repaired by parties other than NATC, or the failure of the user to apply appropriate preventative maintenance or service. No product shall be returned to NATC without its prior consent. Product which NATC consents to be returned shall be sent freight prepaid. Complete information regarding the complaint must be furnished to NATC prior to consent to be returned. NATC will not assume responsibility or accept invoices for unauthorized repairs to its products. NATC makes no warranty as to fitness of its products for specific applications by the user unless NATC specifically agrees otherwise in writing after review of the proposed usage, nor does NATC make any warranty as to period

of service or productivity of its products. No claims for defective merchandise will be considered after one year from date of purchase. THIS WARRANTY IS IN LIEU OF ALL OTHER WARRANTIES, EXPRESSED OR IMPLIED, INCLUDING ANY IMPLIED WARRANTY OF MERCHANTABILITY OR FITNESS FOR A PARTICULAR PURPOSE. NATC shall have no liability or responsibility on any claim of any kind, whether in contract, tort or otherwise, for any loss or damage arising out of, connected with, or resulting from the manufacture, sale, delivery or use of any product sold hereunder, in excess of the cost of replacement or repair as provided herein. IN NO EVENT SHALL NATC BE LIABLE FOR ANY SPECIAL, INCIDENTAL, OR CONSEQUENTIAL DAMAGES. NATC makes no warranty, express or implied, except as set forth above; and NATC neither assumes nor authorizes any other person or entity to assume for it any other obligation or liability in connection with any of its products.

**WARNING:** Cutting tools may shatter or break. Please wear eye protection and use adequate safeguards.

## PROUDLY AFFILIATED WITH...



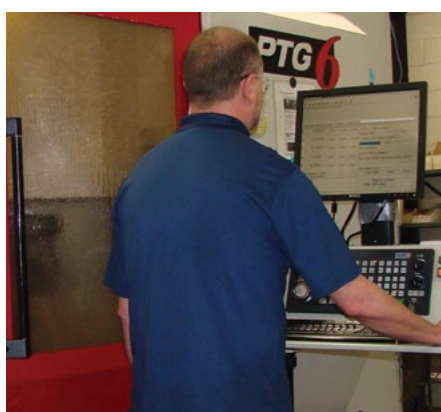
## ISO CERTIFICATION

As part of North American Tool's quality assurance initiative, we are a registered manufacturer conforming to the ISO 9001 Management System Standard. The design and manufacture of our products is accredited by this international quality system and we strive to keep our registration in compliance with the current standard. To obtain a copy of our Certificate of Compliance, please visit our website or contact Customer Service.





# WORLD CLASS TOOLING THROUGH TEAM-DRIVEN COMMITMENT





# SPECIAL TAPS APPLICATION DATA SHEET



North American Tool can design and manufacture special taps based on your specific application or recommendations. By providing as much detailed information as possible on your application, our engineers can design a tap that meets your exact requirements.

*Be sure to include pertinent comments, blueprints or sketches.*

Customer Name: \_\_\_\_\_ Date: \_\_\_\_ / \_\_\_\_ / \_\_\_\_  
 City/State/Zip: \_\_\_\_\_ Distributor: \_\_\_\_\_  
 Phone: \_\_\_\_\_ Fax: \_\_\_\_\_ E-Mail: \_\_\_\_\_  
 Contact: \_\_\_\_\_ Title: \_\_\_\_\_ Extn.: \_\_\_\_\_  
 Company: \_\_\_\_\_

## GENERAL INFORMATION

(Application) B/P or Job # \_\_\_\_\_

Tool Description \_\_\_\_\_

Tap Style \_\_\_\_\_ Class of Fit \_\_\_\_\_ H-Limit \_\_\_\_\_ Thread Form \_\_\_\_\_

Surface Treatment \_\_\_\_\_ Cutting/Forming \_\_\_\_\_ Blind/Thru Hole \_\_\_\_\_

Hole Depth \_\_\_\_\_ Thread Length \_\_\_\_\_ Tap Drill Size \_\_\_\_\_ % of Thread \_\_\_\_\_

Machine Tool \_\_\_\_\_ Condition \_\_\_\_\_ Horiz./Vert. \_\_\_\_\_

Coolant \_\_\_\_\_ Mix \_\_\_\_\_ Speed (SFM) \_\_\_\_\_ # Taps/Set-Up \_\_\_\_\_

Holder: Tension/Compression \_\_\_\_\_ Rigid Collet \_\_\_\_\_ Floating \_\_\_\_\_

Material \_\_\_\_\_ Hardness \_\_\_\_\_ Characteristics \_\_\_\_\_

Feed:  CNC control  NC control  Synchronous Spindle  Manual

Cam Followed  Lead Screw

Unique job details: \_\_\_\_\_

Comments:

---

---

---

---

---

---

---

---

---

---

---

---

---

---

---

---

---

---

---

---



## Other trusted brands from the North American Tool family of products:

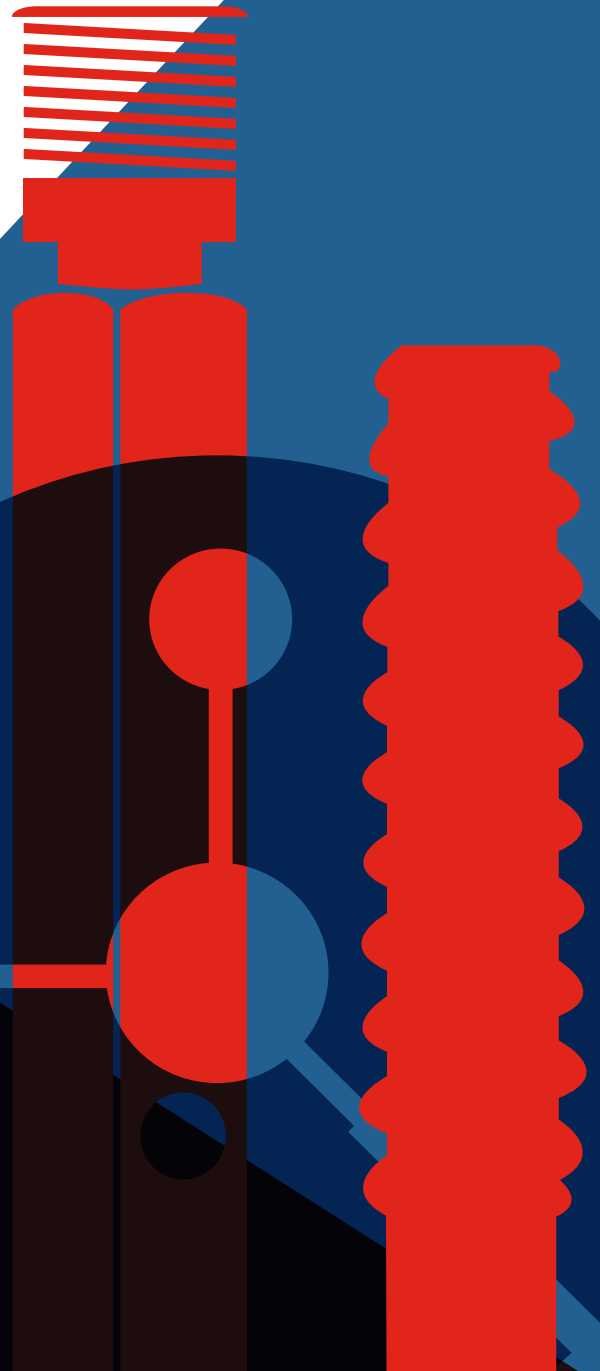


[www.gayleesaws.com](http://www.gayleesaws.com)  
[sales@gayleesaws.com](mailto:sales@gayleesaws.com)  
800-435-5800

- Solid Carbide Thin Saws
- Carbide-Tipped Thin Saws
- Special Purpose Saws, Cutters and Thread Mills
- 24 Hour Shipment of Solid Carbide Thin Saws (Up to 6 pcs.)
- Special, Application-Specific Tooling and Cutters
- Drills
- Reamers
- Subland Tooling
- Circular and Dovetail Form Tooling
- Recess Cutters
- Milling Cutters
- Hobs
- Multiple-Diameter Tooling
- Cut-off Tools
- Combination Tooling
- Turning Tools
- Thread Roll Dies
- Blueprint Special Tooling Designed for Specific Applications



**2018 PRICE LIST**  
Special Taps, Dies & Gages



Effective 8-1-2018  
Prices and conditions are subject to change without notice.

Click on Item Number for Catalog Listing

SIZE/ DESCRIPTION	GH #	CLASS OF FIT	# FLUTES	ITEM #		1 PC	2 PC	3 PC	6 PC	9 PC	12 PC	24 PC	48 PC
				PLUG	BOTTOM								
<b>#00-90 NS</b>						<i>Recommended Hole Size Based on 75% Thread = .0362"</i>							
SPIRAL POINT TAP	1	3B		15001		\$94.00	\$62.60	\$52.20	\$41.70	\$38.20	\$36.50	\$33.90	\$31.30
<b>#00-96 NS</b>						<i>Recommended Hole Size Based on 75% Thread = .0370"</i>							
SPIRAL POINT TAP	1	3B		15003		\$94.00	\$62.60	\$52.20	\$41.70	\$38.20	\$36.50	\$33.90	\$31.30
<b>#0-80 NF</b>						<i>Recommended Hole Size Based on 75% Thread = .0479" TRU-FLO at 65% Thread = .0545"</i>							
L.H. HAND TAP	1	3B	2	17951	17952	\$75.80	\$75.80	\$75.80	\$54.90	\$54.90	\$33.60	\$27.00	\$24.20
L.H. SPIRAL POINT TAP	1	3B		15012		\$72.20	\$51.30	\$40.80	\$30.40	\$26.80	\$25.10	\$22.50	\$19.90
L.H. SPIRAL POINT TAP	1	3B	2	17953		\$72.20	\$51.30	\$40.80	\$30.40	\$26.80	\$25.10	\$22.50	\$19.90
SPIRAL POINT TAP	3			15008		\$72.20	\$51.30	\$40.80	\$30.40	\$26.80	\$25.10	\$22.50	\$19.90
TRU-FLO FORM TAP	2	3B			19000	\$72.30	\$51.50	\$41.10	\$30.50	\$26.90	\$25.40	\$22.80	\$20.50
TRU-FLO FORM TAP	3	2B			19001	\$72.30	\$51.50	\$41.10	\$30.50	\$26.90	\$25.40	\$22.80	\$20.50
SOLID CARBIDE / HAND TAP	2	2B	2	41579	41580	\$87.10	\$79.60	\$75.20	\$73.30	\$72.90	\$64.40	\$62.20	\$59.80
GAGE - Taperlock Style		2B		23003		\$134.00							
GAGE - Taperlock Style		3B		23004		\$134.00							
GAGE - Reversible Style		2B		24194		\$172.00							
GAGE - Reversible Style		3B		24195		\$172.00							
GAGE - Ring-Go		2A		23350		\$186.40							
GAGE - Ring-Go		3A		23351		\$186.40							
GAGE - Ring-NoGo		2A		23352		\$186.40							
GAGE - Ring-NoGo		3A		23353		\$186.40							
<b>#1-56 NS</b>													
SPIRAL POINT TAP	1	3B		15020		\$66.90	\$47.70	\$37.30	\$26.80	\$23.20	\$21.60	\$19.00	\$16.40
<b>#1-64 NC</b>						<i>Recommended Hole Size Based on 75% Thread = .0559"</i>							
TRU-FLO FORM TAP	2	3B			19002	\$66.90	\$47.70	\$37.30	\$26.80	\$23.20	\$21.60	\$19.00	\$17.30
TRU-FLO FORM TAP	3	2B			19003	\$66.90	\$47.70	\$37.30	\$26.80	\$23.20	\$21.60	\$19.00	\$17.30
GAGE - Taperlock Style		2B		23008		\$134.00							
GAGE - Taperlock Style		3B		23009		\$134.00							
GAGE - Reversible Style		2B		24199		\$172.00							
GAGE - Reversible Style		3B		24200		\$172.00							
GAGE - Ring-Go		2A		23356		\$170.10							
GAGE - Ring-Go		3A		23357		\$170.10							
GAGE - Ring-NoGo		2A		23358		\$170.10							
GAGE - Ring-NoGo		3A		23359		\$170.10							
<b>#1-72 NF</b>						<i>Recommended Hole Size Based on TRU-FLO at 65% Thread = .0669"</i>							
TRU-FLO FORM TAP	2	3B			19004	\$66.90	\$47.70	\$37.30	\$26.80	\$23.20	\$21.60	\$19.00	\$17.30
TRU-FLO FORM TAP	3	2B			19005	\$66.90	\$47.70	\$37.30	\$26.80	\$23.20	\$21.60	\$19.00	\$17.30
GAGE - Taperlock Style		2B		23013		\$134.00							
GAGE - Taperlock Style		3B		23014		\$134.00							
GAGE - Reversible Style		2B		24204		\$172.00							
GAGE - Reversible Style		3B		24205		\$172.00							
GAGE - Ring-Go		2A		23362		\$170.10							
GAGE - Ring-Go		3A		23363		\$170.10							
GAGE - Ring-NoGo		2A		23364		\$170.10							
GAGE - Ring-NoGo		3A		23365		\$170.10							

TAPS, DIES & GAGES

Click on Item Number for Catalog Listing

SIZE/ DESCRIPTION	GH #	CLASS OF FIT	# FLUTES	ITEM #		1 PC	2 PC	3 PC	6 PC	9 PC	12 PC	24 PC	48 PC
				PLUG	BOTTOM								
<b>#2-56 NC</b>						<i>Recommended Hole Size Based on 75% Thread = .0689" TRU-FLO at 65% Thread = .0781"</i>							
L.H. HAND TAP	2	2B	2	15038	15039	\$60.50	\$47.60	\$37.10	\$26.70	\$23.10	\$21.50	\$18.90	\$16.20
L H. SPIRAL POINT TAP	2	2B	2	15036		\$61.40	\$48.50	\$38.10	\$27.60	\$24.10	\$22.40	\$19.80	\$17.20
SPIRAL POINT TAP	3		2	17734		\$72.60	\$58.20	\$53.10	\$42.70	\$39.10	\$29.50	\$26.90	\$24.30
HAND TAP	4		2	17763	17764	\$71.20	\$57.00	\$50.40	\$39.90	\$27.80	\$25.00	\$22.90	\$20.00
SPIRAL POINT TAP	4		2	17735		\$72.60	\$58.20	\$53.10	\$42.70	\$39.10	\$29.50	\$26.90	\$24.30
SPIRAL POINT TAP	5		2	17668		\$61.40	\$48.50	\$45.20	\$34.70	\$31.00	\$29.50	\$26.90	\$24.30
SPIRAL POINT +.003 TAP	7		2	17691		\$72.70	\$58.00	\$40.70	\$33.50	\$28.40	\$25.40	\$23.40	\$20.40
TRU-FLO FORM TAP	2	3B			19006	\$66.90	\$47.70	\$37.30	\$26.80	\$23.20	\$21.60	\$19.00	\$17.30
TRU-FLO FORM TAP	3	2B			19007	\$66.90	\$47.70	\$37.30	\$26.80	\$23.20	\$21.60	\$19.00	\$17.30
SOLID CARBIDE / HAND TAP	2	2B	2	41536	41537	\$87.10	\$79.60	\$75.20	\$73.30	\$72.90	\$64.40	\$62.20	\$59.80
SOLID CARBIDE / SP PT TAP	2	2B	2	41538		\$89.40	\$81.90	\$77.50	\$75.60	\$75.10	\$66.60	\$64.50	\$62.10
GAGE - Taperlock Style		2B		23018		\$130.30							
GAGE - Taperlock Style		3B		23019		\$130.30							
GAGE - Reversible Style		2B		24209		\$172.00							
GAGE - Reversible Style		3B		24210		\$172.00							
GAGE - Ring-Go		2A		23368		\$162.90							
GAGE - Ring-Go		3A		23369		\$162.90							
GAGE - Ring-NoGo		2A		23370		\$162.90							
GAGE - Ring-NoGo		3A		23371		\$162.90							
GAGE - STI Plug Taperlock Style		2B		24597		\$173.60							
GAGE - STI Plug Taperlock Style		3B		24598		\$173.60							
<b>#2-64 NF</b>						<i>Recommended Hole Size Based on TRU-FLO at 65% Thread = .0791"</i>							
TRU-FLO FORM TAP	2	3B			19008	\$66.90	\$47.70	\$37.30	\$26.80	\$23.20	\$21.60	\$19.00	\$17.30
TRU-FLO FORM TAP	3	2B			19009	\$66.90	\$47.70	\$37.30	\$26.80	\$23.20	\$21.60	\$19.00	\$17.30
GAGE - Taperlock Style		2B		23023		\$130.30							
GAGE - Taperlock Style		3B		23024		\$130.30							
GAGE - Reversible Style		2B		24214		\$172.00							
GAGE - Reversible Style		3B		24215		\$172.00							
GAGE - Ring-Go		2A		23374		\$162.90							
GAGE - Ring-Go		3A		23375		\$162.90							
GAGE - Ring-NoGo		2A		23376		\$162.90							
GAGE - Ring-NoGo		3A		23377		\$162.90							
<b>#3-48 NC</b>						<i>Recommended Hole Size Based on 75% Thread = .079" TRU-FLO at 65% Thread = .0898"</i>							
L.H. HAND TAP	2	2B	2	15050	15051	\$48.60	\$43.00	\$33.00	\$23.00	\$19.60	\$18.00	\$15.50	\$13.00
L H. SPIRAL POINT TAP	2	2B	2	15048		\$49.50	\$43.90	\$33.90	\$23.90	\$20.50	\$18.90	\$16.40	\$13.90
TRU-FLO FORM TAP	2	3B			19010	\$64.00	\$45.60	\$35.60	\$25.60	\$22.20	\$20.60	\$18.10	\$16.50
TRU-FLO FORM TAP	3	2B			19011	\$64.00	\$45.60	\$35.60	\$25.60	\$22.20	\$20.60	\$18.10	\$16.50
GAGE - Taperlock Style		2B		23028		\$117.70							
GAGE - Taperlock Style		3B		23029		\$117.70							
GAGE - Reversible Style		2B		24219		\$154.20							
GAGE - Reversible Style		3B		24220		\$154.20							
GAGE - Ring-Go		2A		23380		\$155.80							
GAGE - Ring-Go		3A		23381		\$155.80							
GAGE - Ring-NoGo		2A		23382		\$155.80							
GAGE - Ring-NoGo		3A		23383		\$155.80							



Click on Item Number for Catalog Listing

SIZE/ DESCRIPTION	GH #	CLASS OF FIT	# FLUTES	ITEM #		1 PC	2 PC	3 PC	6 PC	9 PC	12 PC	24 PC	48 PC
				PLUG	BOTTOM								
<b>#3-48 NC</b>				<i>See Previous Page for Recommended Hole Size</i>									
GAGE - STI Taperlock Style		2B		22028		\$134.40							
GAGE - STI Taperlock Style		3B		22029		\$134.40							
<b>#3-56 NF</b>				<i>Recommended Hole Size Based on TRU-FLO at 65% Thread = .0911"</i>									
TRU-FLO FORM TAP	2	3B			19012	\$66.90	\$47.70	\$37.30	\$26.80	\$23.20	\$21.60	\$19.00	\$17.30
TRU-FLO FORM TAP	3	2B			19013	\$66.90	\$47.70	\$37.30	\$26.80	\$23.20	\$21.60	\$19.00	\$17.30
GAGE - Taperlock Style		2B			23033	\$123.00							
GAGE - Taperlock Style		3B			23034	\$123.00							
GAGE - Reversible Style		2B			24224	\$161.20							
GAGE - Reversible Style		3B			24225	\$161.20							
GAGE - Ring-Go		2A			23386	\$162.90							
GAGE - Ring-Go		3A			23387	\$162.90							
GAGE - Ring-NoGo		2A			23388	\$162.90							
GAGE - Ring-NoGo		3A			23389	\$162.90							
GAGE - STI Taperlock Style		2B			22038	\$134.40							
GAGE - STI Taperlock Style		3B			22039	\$134.40							
<b>#4-32 NS</b>				<i>Recommended Hole Size Based on 75% Thread = .0817"</i>									
HAND TAP	2	2B	3	15062	15063	\$45.40	\$36.10	\$25.20	\$23.10	\$19.60	\$17.90	\$15.30	\$12.70
<b>#4-36 NS</b>				<i>Recommended Hole Size Based on 75% Thread = .0850"</i>									
HAND TAP	2	2B	3	17946	17947	\$78.70	\$58.50	\$48.00	\$31.50	\$22.40	\$17.90	\$15.30	\$12.70
<b>#4-40 NC</b>				<i>Recommended Hole Size Based on 75% Thread = .0878" for STI = .1200" / TRU-FLO at 65% Thread = .1009"</i>									
FAST SPIRAL FLUTE TAP	3		2	17672	17673	\$38.00	\$35.70	\$30.90	\$25.20	\$21.70	\$20.00	\$17.40	\$14.80
L.H. HAND TAP	2	2B	3	15074	15075	\$21.30	\$19.10	\$17.00	\$15.90	\$15.30	\$14.90	\$14.50	\$13.80
L.H. SPIRAL POINT TAP	2	2B	2	15072		\$24.90	\$21.40	\$18.00	\$16.80	\$16.00	\$15.60	\$15.20	\$14.50
HAND TAP	3		3	15080	15081	\$37.10	\$36.30	\$33.40	\$27.80	\$20.40	\$16.80	\$13.80	\$12.70
SPIRAL POINT TAP	3		2	15078		\$24.90	\$21.40	\$18.00	\$16.80	\$16.00	\$15.60	\$15.20	\$14.20
SPIRAL POINT TAP	4		2	17910		\$42.40	\$41.40	\$38.10	\$31.80	\$27.30	\$19.90	\$15.20	\$14.20
SPIRAL POINT TAP	5		2	17593		\$42.30	\$41.40	\$38.10	\$31.80	\$23.40	\$19.90	\$15.20	\$14.30
+.003 SPIRAL POINT TAP	7		2	17670		\$45.20	\$41.40	\$38.10	\$31.80	\$23.40	\$22.70	\$19.50	\$17.80
+.005 SPIRAL POINT TAP	11	PLATING	2	17557		\$44.80	\$41.40	\$38.10	\$31.80	\$29.90	\$24.70	\$22.10	\$19.50
TRU-FLO FORM TAP	3	3B		19014	19015	\$39.10	\$36.50	\$33.10	\$28.70	\$25.10	\$23.50	\$20.80	\$18.20
TRU-FLO FORM TAP	5	2B		19016	19017	\$39.10	\$36.50	\$33.10	\$28.70	\$25.10	\$23.50	\$20.80	\$18.20
SOLID CARBIDE / HAND TAP	2	2B	2	41007	41008	\$87.10	\$79.60	\$75.20	\$73.30	\$72.90	\$64.40	\$62.20	\$59.80
SOLID CARBIDE / SP PT TAP	2	2B	2	41009		\$89.80	\$82.30	\$77.90	\$76.00	\$75.60	\$67.10	\$64.90	\$62.50
COST CUTTER DRILL/TAP	2	2B	2	29000		\$15.50	\$15.50	\$15.50	\$15.50	\$15.50	\$15.50	\$15.50	\$15.50
TiN COAT/SP PT TAP	4		2	50034		\$43.90	\$43.00	\$39.70	\$33.40	\$28.90	\$21.50	\$16.80	\$15.70
STI HAND TAP	1	3B	3	17794	17795	\$20.70	\$19.80	\$18.20	\$17.30	\$16.60	\$15.20	\$14.30	\$12.80
STI SPIRAL POINT TAP	1	3B	2	17796		\$22.30	\$21.20	\$19.60	\$18.70	\$17.90	\$16.60	\$15.60	\$14.20
STI HAND TAP	2	2B	3	17798	17799	\$20.70	\$19.80	\$18.20	\$17.30	\$16.60	\$15.20	\$14.30	\$12.80
STI SPIRAL POINT TAP	2	2B	2	17800		\$22.30	\$21.20	\$19.60	\$18.70	\$17.90	\$16.60	\$15.60	\$14.20
GAGE - Taperlock Style		2B			23038	\$123.00							
GAGE - Taperlock Style		3B			23039	\$123.00							
GAGE - Reversible Style		2B			24229	\$161.20							
GAGE - Reversible Style		3B			24230	\$161.20							
GAGE - Ring-Go		2A			23392	\$144.90							
GAGE - Ring-Go		3A			23393	\$144.90							
GAGE - Ring-NoGo		2A			23394	\$144.90							

TAPS, DIES & GAGES

Click on Item Number for Catalog Listing

SIZE/ DESCRIPTION	GH #	CLASS OF FIT	# FLUTES	ITEM #		1 PC	2 PC	3 PC	6 PC	9 PC	12 PC	24 PC	48 PC
				PLUG	BOTTOM								
<b>#4-40 NC</b>						<i>See Previous Page for Recommended Hole Size</i>							
GAGE - Ring-NoGo		3A		23395		\$144.90							
GAGE - STI Plug Taperlock Style		2B		24617		\$166.70							
GAGE - STI Plug Taperlock Style		3B		24618		\$166.70							
<b>#4-48 NF</b>						<i>Recommended Hole Size Based on 75% Thread = .092" TRU-FLO at 65% Thread = .1028"</i>							
L.H. HAND TAP	2	2B	3	15086	15087	\$37.10	\$36.30	\$33.40	\$27.80	\$20.40	\$16.80	\$13.80	\$12.70
L.H. SPIRAL POINT TAP	2	2B	2	15083		\$41.50	\$36.50	\$35.30	\$29.10	\$20.80	\$15.60	\$15.20	\$14.20
TRU-FLO FORM TAP	3	3B		19018	19019	\$39.10	\$36.50	\$33.10	\$28.70	\$25.10	\$23.50	\$20.80	\$18.20
TRU-FLO FORM TAP	5	2B		19020	19021	\$39.10	\$36.50	\$33.10	\$28.70	\$25.10	\$23.50	\$20.80	\$18.20
SOLID CARBIDE / HAND TAP	2	2B	2	41017	41018	\$87.10	\$79.60	\$75.20	\$73.30	\$72.90	\$64.40	\$62.20	\$59.80
SOLID CARBIDE / SP PT TAP	2	2B	2	41019		\$89.80	\$82.30	\$77.90	\$76.00	\$75.60	\$67.10	\$64.90	\$62.50
GAGE - Taperlock Style		2B		23043		\$123.00							
GAGE - Taperlock Style		3B		23044		\$123.00							
GAGE - Reversible Style		2B		24234		\$161.20							
GAGE - Reversible Style		3B		24235		\$161.20							
GAGE - Ring-Go		2A		23398		\$144.90							
GAGE - Ring-Go		3A		23399		\$144.90							
GAGE - Ring-NoGo		2A		23400		\$144.90							
GAGE - Ring-NoGo		3A		23401		\$144.90							
GAGE - STI Plug Taperlock Style		2B		24622		\$166.70							
GAGE - STI Plug Taperlock Style		3B		24623		\$166.70							
<b>#5-40 NC</b>						<i>Recommended Hole Size Based on 75% Thread = .1008" TRU-FLO at 65% Thread = .1139"</i>							
L.H. HAND TAP	2	3B	3	15098	15099	\$39.80	\$36.30	\$33.40	\$27.80	\$20.40	\$13.40	\$11.80	\$11.00
L.H. SPIRAL POINT TAP	2	3B	2	15096		\$41.50	\$36.50	\$35.30	\$29.10	\$20.80	\$15.60	\$15.20	\$14.20
SPIRAL POINT TAP	5		2	17697		\$44.70	\$39.30	\$38.00	\$34.00	\$29.90	\$22.70	\$19.50	\$17.80
+.003 SPIRAL POINT TAP	7		2	17954		\$72.20	\$51.30	\$40.80	\$30.40	\$26.80	\$25.10	\$22.50	\$19.90
+.005 SPIRAL POINT TAP	11	PLATING	2	17675		\$61.00	\$49.40	\$39.30	\$28.70	\$24.40	\$22.70	\$19.50	\$17.80
TRU-FLO FORM TAP	3	3B		19022	19023	\$39.10	\$36.50	\$33.10	\$28.70	\$25.10	\$23.50	\$20.80	\$18.20
TRU-FLO FORM TAP	5	2B		19024	19025	\$39.10	\$36.50	\$33.10	\$28.70	\$25.10	\$23.50	\$20.80	\$18.20
SOLID CARBIDE / HAND TAP	2	3B	3	41034	41035	\$87.10	\$79.60	\$75.20	\$73.30	\$72.90	\$64.40	\$62.20	\$59.80
SOLID CARBIDE / SP PT TAP	2	3B	2	41032		\$89.50	\$82.00	\$77.60	\$75.70	\$75.20	\$66.00	\$63.80	\$61.50
TiN COAT/SP PT TAP	5		2	50029		\$46.20	\$40.90	\$39.60	\$35.60	\$31.50	\$24.30	\$21.10	\$19.40
R.H. ROUND DIE 13/16"OD				13020		\$31.30	\$31.30	\$31.30	\$29.80	\$28.50	\$26.10	\$25.10	\$24.90
GAGE - Taperlock Style		2B		23048		\$112.20							
GAGE - Taperlock Style		3B		23049		\$112.20							
GAGE - Reversible Style		2B		24239		\$142.90							
GAGE - Reversible Style		3B		24240		\$142.90							
GAGE - Ring-Go		2A		23404		\$132.10							
GAGE - Ring-Go		3A		23405		\$132.10							
GAGE - Ring-NoGo		2A		23406		\$132.10							
GAGE - Ring-NoGo		3A		23407		\$132.10							
GAGE - STI Plug Taperlock Style		2B		24627		\$166.70							
GAGE - STI Plug Taperlock Style		3B		24628		\$166.70							
<b>#5-44 NF</b>						<i>Recommended Hole Size Based on TRU-FLO at 65% Thread = .1150"</i>							
TRU-FLO FORM TAP	3	3B		19026	19027	\$39.10	\$36.50	\$33.10	\$28.70	\$25.10	\$23.50	\$20.80	\$18.20
TRU-FLO FORM TAP	5	2B		19028	19029	\$39.10	\$36.50	\$33.10	\$28.70	\$25.10	\$23.50	\$20.80	\$18.20





Click on Item Number  
for Catalog Listing

SIZE/ DESCRIPTION	GH #	CLASS OF FIT	# FLUTES	ITEM #		1 PC	2 PC	3 PC	6 PC	9 PC	12 PC	24 PC	48 PC
				PLUG	BOTTOM								
<b>#5-44 NF</b>				<i>See Previous Page for Recommended Hole Size</i>									
GAGE - Taperlock Style		2B		23053		\$112.20							
GAGE - Taperlock Style		3B		23054		\$112.20							
GAGE - Reversible Style		2B		24244		\$142.90							
GAGE - Reversible Style		3B		24245		\$142.90							
GAGE - Ring-Go		2A		23410		\$132.10							
GAGE - Ring-Go		3A		23411		\$132.10							
GAGE - Ring-NoGo		2A		23412		\$132.10							
GAGE - Ring-NoGo		3A		23413		\$132.10							
<b>#6-32 NC</b>				<i>Recommended Hole Size based on 75% Thread = .1077" for STI = .1495" / TRU-FLO at 65% Thread = .1242"</i>									
L.H. HAND TAP	3	2B	3	15110	15111	\$8.70	\$8.70	\$8.70	\$8.70	\$8.70	\$8.70	\$8.70	\$8.70
L.H. SPIRAL POINT TAP	3	2B	2	15108		\$15.70	\$15.30	\$15.30	\$15.30	\$15.30	\$13.30	\$13.00	\$12.70
HAND TAP	5		3	15122	15123	\$32.50	\$31.70	\$31.00	\$25.10	\$19.70	\$15.60	\$13.30	\$11.60
SPIRAL POINT TAP	5		2	15120		\$36.20	\$33.60	\$30.90	\$25.80	\$18.90	\$16.60	\$14.40	\$13.40
+.003 HAND TAP	7		3	15128	15129	\$32.30	\$31.60	\$31.00	\$24.30	\$18.40	\$15.50	\$11.80	\$9.10
+.003 SPIRAL POINT TAP	7		2	15126		\$33.00	\$31.90	\$30.90	\$25.80	\$18.90	\$16.60	\$14.40	\$13.40
+.005 HAND TAP	11	PLATING	3	15134	15135	\$12.60	\$12.60	\$12.60	\$12.60	\$12.60	\$12.60	\$11.80	\$9.10
+.005 SPIRAL POINT TAP	11	PLATING	2	15132		\$10.40	\$10.40	\$10.40	\$10.40	\$9.60	\$8.20	\$8.20	\$8.20
4" EXTENSION SPIRAL POINT TAP	3	2B	2	17605		\$34.00	\$33.40	\$32.70	\$29.40	\$28.20	\$25.70	\$22.30	\$19.40
6" EXTENSION HAND TAP	3	2B	3	15140	15141	\$27.70	\$27.70	\$27.70	\$27.70	\$27.70	\$27.70	\$27.70	\$24.80
6" EXTENSION SPIRAL POINT TAP	3	2B	2	15138		\$29.00	\$29.00	\$29.00	\$29.00	\$29.00	\$29.00	\$29.00	\$26.20
TRU-FLO FORM TAP	3	3B		19030	19031	\$36.30	\$33.40	\$30.10	\$25.90	\$22.30	\$20.60	\$18.00	\$15.40
TRU-FLO FORM TAP	5	2B		19032	19033	\$36.30	\$33.40	\$30.10	\$25.90	\$22.30	\$20.60	\$18.00	\$15.40
TRU-FLO FORM TAP	10	PLATING		19034	19035	\$36.30	\$33.40	\$30.10	\$25.90	\$22.30	\$20.60	\$18.00	\$15.40
SOLID CARBIDE / HAND TAP	3	2B	3	41074	41075	\$66.60	\$66.60	\$66.60	\$66.60	\$66.60	\$58.20	\$56.80	\$55.40
SOLID CARBIDE / SP PT TAP	3	2B	2	41072		\$69.00	\$69.00	\$69.00	\$69.00	\$69.00	\$59.80	\$58.40	\$57.10
COST CUTTER DRILL/TAP	3	2B	2	29004		\$15.30	\$15.30	\$15.30	\$15.30	\$15.30	\$15.30	\$15.30	\$15.30
STI HAND TAP	2	3B	3	17802	17803	\$20.70	\$19.80	\$18.20	\$17.30	\$16.60	\$15.20	\$14.30	\$12.80
STI SPIRAL POINT TAP	2	3B	2	17804		\$22.30	\$21.20	\$19.60	\$18.70	\$17.90	\$16.60	\$15.60	\$14.20
STI HAND TAP	3	2B	3	17806	17807	\$20.70	\$19.80	\$18.20	\$17.30	\$16.60	\$15.20	\$14.30	\$12.80
STI SPIRAL POINT TAP	3	2B	2	17808		\$22.30	\$21.20	\$19.60	\$18.70	\$17.90	\$16.60	\$15.60	\$14.20
R.H. ROUND DIE 1"OD				13022		\$38.70	\$38.70	\$38.70	\$33.00	\$31.40	\$28.80	\$27.70	\$27.50
L.H. ROUND DIE 1"OD				13023		\$87.00	\$65.40	\$57.70	\$39.60	\$37.70	\$34.40	\$29.50	\$29.30
GAGE - Taperlock Style		2B		23058		\$112.20							
GAGE - Taperlock Style		3B		23059		\$112.20							
GAGE - Reversible Style		2B		24249		\$142.90							
GAGE - Reversible Style		3B		24250		\$142.90							
GAGE - Ring-Go		2A		23416		\$132.10							
GAGE - Ring-Go		3A		23417		\$132.10							
GAGE - Ring-NoGo		2A		23418		\$132.10							
GAGE - Ring-NoGo		3A		23419		\$132.10							
GAGE - STI Plug Taperlock Style		2B		24637		\$166.70							
GAGE - STI Plug Taperlock Style		3B		24638		\$166.70							
<b>#6-40 NF</b>				<i>Recommended Hole Size based on 75% Thread = .1138" TRU-FLO at 65% Thread = .1269"</i>									
L.H. HAND TAP	2	3B	3	15146	15147	\$30.40	\$30.40	\$30.40	\$25.20	\$20.20	\$14.90	\$12.80	\$11.80
SPIRAL POINT TAP	3		2	15150		\$33.30	\$33.30	\$33.30	\$27.70	\$22.00	\$16.50	\$13.00	\$11.60
TRU-FLO FORM TAP	3	3B		19036	19037	\$36.30	\$33.40	\$30.10	\$25.90	\$22.30	\$20.60	\$18.00	\$15.40

TAPS, DIES & GAGES

Click on Item Number for Catalog Listing

SIZE/ DESCRIPTION	GH #	CLASS OF FIT	# FLUTES	ITEM #		1 PC	2 PC	3 PC	6 PC	9 PC	12 PC	24 PC	48 PC
				PLUG	BOTTOM								
<b>#6-40 NF</b>				<i>See Previous Page for Recommended Hole Size</i>									
TRU-FLO FORM TAP	5	2B		19038	19039	\$36.30	\$33.40	\$30.10	\$25.90	\$22.30	\$20.60	\$18.00	\$15.40
SOLID CARBIDE / HAND TAP	2	3B	3	41092	41093	\$66.60	\$66.60	\$66.60	\$66.60	\$66.60	\$58.20	\$56.80	\$55.40
R.H. ROUND DIE 1"OD				13024		\$38.70	\$38.70	\$38.70	\$33.00	\$31.40	\$28.80	\$27.70	\$27.50
L.H. ROUND DIE 1"OD				13025		\$87.00	\$65.40	\$57.70	\$39.60	\$37.70	\$34.40	\$29.50	\$29.30
GAGE - Taperlock Style		2B		23063		\$112.20							
GAGE - Taperlock Style		3B		23064		\$112.20							
GAGE - Reversible Style		2B		24254		\$142.90							
GAGE - Reversible Style		3B		24255		\$142.90							
GAGE - Ring-Go		2A		23422		\$132.10							
GAGE - Ring-Go		3A		23423		\$132.10							
GAGE - Ring-NoGo		2A		23424		\$132.10							
GAGE - Ring-NoGo		3A		23425		\$132.10							
GAGE - STI Plug Taperlock Style		2B		24642		\$166.70							
GAGE - STI Plug Taperlock Style		3B		24643		\$166.70							
<b>#6-48 NS</b>				<i>Recommended Hole Size based on 75% Thread = .118"</i>									
HAND TAP	2	3B	3	15158	15159	\$31.90	\$31.30	\$28.80	\$24.00	\$20.20	\$16.00	\$13.30	\$12.20
SPIRAL POINT TAP	2	3B	2	15156		\$33.30	\$33.30	\$33.30	\$27.70	\$22.00	\$16.50	\$13.00	\$11.60
R.H. ROUND DIE 1"OD				13026		\$87.00	\$65.40	\$57.70	\$39.60	\$37.70	\$34.40	\$29.50	\$29.30
<b>#8-24 NS</b>				<i>Recommended Hole Size based on 75% Thread = .123"</i>									
HAND TAP	3	3B	4	15164	15165	\$33.60	\$33.00	\$30.30	\$28.70	\$19.50	\$16.00	\$13.30	\$12.20
<b>#8-32 NC</b>				<i>Recommended Hole Size based on 75% Thread = .1337" for STI = .1770" / TRU-FLO at 65% Thread = .1502"</i>									
L.H. HAND TAP	3	2B	4	15170	15171	\$8.70	\$8.70	\$8.70	\$8.70	\$8.70	\$8.70	\$8.70	\$8.70
L.H. SPIRAL POINT TAP	3	2B	2	15168		\$29.90	\$29.90	\$29.90	\$29.90	\$21.40	\$17.20	\$14.40	\$13.40
HAND TAP	5		4	15182	15183	\$33.60	\$33.00	\$30.30	\$28.60	\$19.50	\$16.00	\$13.30	\$12.20
SPIRAL POINT TAP	5		2	15180		\$36.60	\$28.70	\$26.40	\$23.90	\$20.30	\$17.20	\$14.40	\$13.40
+.003 HAND TAP	7		4	15188	15189	\$12.20	\$12.20	\$12.20	\$12.20	\$12.20	\$12.20	\$12.20	\$12.20
+.003 SPIRAL POINT TAP	7		2	15186		\$13.40	\$13.40	\$13.40	\$13.40	\$13.40	\$13.40	\$13.40	\$13.40
+.005 HAND TAP	11	PLATING	4	15194	15195	\$12.20	\$12.20	\$12.20	\$12.20	\$12.20	\$12.20	\$12.20	\$12.20
+.005 SPIRAL POINT TAP	11	PLATING	2	15192		\$10.60	\$10.60	\$10.60	\$10.60	\$9.70	\$8.00	\$8.00	\$8.00
4" EXTENSION SPIRAL POINT TAP	3	2B	2	17582		\$38.30	\$36.50	\$31.60	\$30.10	\$29.20	\$28.40	\$25.80	\$23.10
6" EXTENSION HAND TAP	3	2B	4	15200	15201	\$27.60	\$27.60	\$27.60	\$27.60	\$27.60	\$27.60	\$27.60	\$23.80
6" EXTENSION SPIRAL POINT TAP	3	2B	2	15198		\$29.00	\$29.00	\$29.00	\$29.00	\$29.00	\$29.00	\$29.00	\$25.10
TRU-FLO FORM TAP	3	3B		19040	19041	\$36.30	\$33.40	\$30.10	\$25.90	\$22.30	\$20.60	\$18.00	\$15.40
TRU-FLO FORM TAP	5	2B		19042	19043	\$36.30	\$33.40	\$30.10	\$25.90	\$22.30	\$20.60	\$18.00	\$15.40
TRU-FLO FORM TAP	10	PLATING		19044	19045	\$36.30	\$33.40	\$30.10	\$25.90	\$22.30	\$20.60	\$18.00	\$15.40
SOLID CARBIDE / HAND TAP	3	2B	4	41125	41126	\$68.00	\$68.00	\$68.00	\$68.00	\$68.00	\$59.50	\$58.00	\$56.80
SOLID CARBIDE / SP PT TAP	3	2B	2	41120		\$70.40	\$70.40	\$70.40	\$70.40	\$70.40	\$61.10	\$59.70	\$58.40
COST CUTTER DRILL/TAP	3	2B	2	29006		\$15.30	\$15.30	\$15.30	\$15.30	\$15.30	\$15.30	\$15.30	\$15.30
TiN COAT/SP PT TAP	5		2	50000		\$39.70	\$31.70	\$29.40	\$26.90	\$23.40	\$20.20	\$17.40	\$16.50
STI HAND TAP	2	3B	3	17810	17811	\$21.60	\$20.30	\$18.80	\$17.80	\$17.10	\$15.50	\$14.90	\$13.50
STI SPIRAL POINT TAP	2	3B	2	17812		\$22.90	\$21.70	\$20.10	\$19.20	\$18.40	\$16.90	\$16.20	\$14.90
STI HAND TAP	3	2B	3	17814	17815	\$21.60	\$20.30	\$18.80	\$17.80	\$17.10	\$15.50	\$14.90	\$13.50
STI SPIRAL POINT TAP	3	2B	2	17816		\$22.90	\$21.70	\$20.10	\$19.20	\$18.40	\$16.90	\$16.20	\$14.90
R.H. ROUND DIE 1"OD				13028		\$38.70	\$38.70	\$38.70	\$33.00	\$31.40	\$28.80	\$27.70	\$27.50
L.H. ROUND DIE 1"OD				13029		\$87.00	\$65.40	\$57.70	\$39.60	\$37.70	\$34.40	\$29.50	\$29.30



Click on Item Number for Catalog Listing

SIZE/ DESCRIPTION	GH #	CLASS OF FIT	# FLUTES	ITEM #		1 PC	2 PC	3 PC	6 PC	9 PC	12 PC	24 PC	48 PC
				PLUG	BOTTOM								
<b>#8-32 NC</b>				<i>See Previous Page for Recommended Hole Size</i>									
GAGE - Taperlock Style		2B		23068		\$112.20							
GAGE - Taperlock Style		3B		23069		\$112.20							
GAGE - Reversible Style		2B		24259		\$142.90							
GAGE - Reversible Style		3B		24260		\$142.90							
GAGE - Ring-Go		2A		23428		\$130.30							
GAGE - Ring-Go		3A		23429		\$130.30							
GAGE - Ring-NoGo		2A		23430		\$130.30							
GAGE - Ring-NoGo		3A		23431		\$130.30							
GAGE - STI Plug Taperlock Style		2B		24647		\$155.70							
GAGE - STI Plug Taperlock Style		3B		24648		\$155.70							
<b>#8-36 NF</b>				<i>Recommended Hole Size based on 75% Thread = .137" TRU-FLO at 65% Thread = .1517"</i>									
L.H. HAND TAP	2	3B	4	15206	15207	\$35.10	\$30.80	\$29.80	\$24.50	\$20.20	\$16.00	\$13.30	\$12.10
L.H. SPIRAL POINT TAP	2	3B	2	15204		\$36.90	\$32.40	\$31.40	\$25.90	\$21.40	\$17.20	\$14.40	\$13.40
TRU-FLO FORM TAP	3	3B		19046	19047	\$36.30	\$33.40	\$30.10	\$25.90	\$22.30	\$20.60	\$18.00	\$15.40
TRU-FLO FORM TAP	5	2B		19048	19049	\$36.30	\$33.40	\$30.10	\$25.90	\$22.30	\$20.60	\$18.00	\$15.40
SOLID CARBIDE / HAND TAP	2	3B	4	41147	41148	\$68.00	\$68.00	\$68.00	\$68.00	\$68.00	\$59.50	\$58.00	\$56.80
GAGE - Taperlock Style		2B		23073		\$112.20							
GAGE - Taperlock Style		3B		23074		\$112.20							
GAGE - Reversible Style		2B		24264		\$142.90							
GAGE - Reversible Style		3B		24265		\$142.90							
GAGE - Ring-Go		2A		23434		\$130.30							
GAGE - Ring-Go		3A		23435		\$130.30							
GAGE - Ring-NoGo		2A		23436		\$130.30							
GAGE - Ring-NoGo		3A		23437		\$130.30							
GAGE - STI Plug Taperlock Style		2B		24652		\$155.70							
GAGE - STI Plug Taperlock Style		3B		24653		\$155.70							
<b>#8-40 NS</b>				<i>Recommended Hole Size based on 75% Thread = .1398"</i>									
HAND TAP	2	3B	4	15218	15219	\$32.80	\$32.80	\$32.80	\$27.20	\$20.20	\$16.00	\$13.30	\$12.20
SPIRAL POINT TAP	2	3B	2	15216		\$34.50	\$34.50	\$34.50	\$28.90	\$21.40	\$17.20	\$14.40	\$13.40
R.H. ROUND DIE 1"OD				13032		\$87.00	\$65.40	\$57.70	\$39.60	\$37.70	\$34.40	\$29.50	\$29.30
<b>#10-24 NC</b>				<i>Recommended Hole Size based on 75% Thread = .149" for STI = .2055" / TRUFLO at 65% Thread = .1716"</i>									
L.H. HAND TAP	3	3B	4	15230	15231	\$12.20	\$12.20	\$12.20	\$12.20	\$12.20	\$12.20	\$12.20	\$12.20
L.H. SPIRAL POINT TAP	3	3B	2	15228		\$34.50	\$34.50	\$34.50	\$28.90	\$21.40	\$17.20	\$14.40	\$13.40
HAND TAP	5		4	15236	15237	\$33.60	\$33.00	\$32.20	\$26.90	\$20.20	\$16.00	\$13.30	\$12.20
SPIRAL POINT TAP	5		2	15234		\$34.50	\$34.50	\$34.50	\$28.90	\$21.40	\$17.20	\$14.40	\$13.40
+.003 HAND TAP	7		4	15242	15243	\$33.60	\$33.00	\$32.20	\$26.90	\$20.20	\$16.00	\$13.30	\$12.20
+.003 SPIRAL POINT TAP	7		2	15240		\$12.40	\$12.40	\$12.40	\$12.40	\$12.40	\$11.80	\$11.80	\$11.80
+.005 HAND TAP	11	PLATING	4	15248	15249	\$9.50	\$9.50	\$9.50	\$9.50	\$8.80	\$7.20	\$7.20	\$7.20
+.005 SPIRAL POINT TAP	11	PLATING	2	15246		\$10.60	\$10.60	\$10.60	\$10.60	\$9.60	\$8.00	\$8.00	\$8.00
DOUBLE LEAD TAP	3	3B	4	15254	15255	\$42.30	\$41.50	\$40.50	\$33.60	\$29.10	\$22.90	\$19.70	\$17.70
4" EXTENSION SPIRAL POINT TAP	3	3B	2	17606		\$35.00	\$33.90	\$33.40	\$30.10	\$29.40	\$29.00	\$27.70	\$26.20
6" EXTENSION HAND TAP	3	3B	4	15260	15261	\$27.70	\$27.70	\$27.70	\$27.70	\$27.70	\$27.70	\$27.70	\$24.80
6" EXTENSION SPIRAL POINT TAP	3	3B	2	15258		\$29.00	\$29.00	\$29.00	\$29.00	\$29.00	\$29.00	\$29.00	\$26.20
TRU-FLO FORM TAP	4	3B		19050	19051	\$36.30	\$33.40	\$30.10	\$25.90	\$22.30	\$20.60	\$18.00	\$15.40
TRU-FLO FORM TAP	6	2B		19052	19053	\$36.30	\$33.40	\$30.10	\$25.90	\$22.30	\$20.60	\$18.00	\$15.40

TAPS, DIES & GAGES

Click on Item Number for Catalog Listing

SIZE/ DESCRIPTION	GH #	CLASS OF FIT	# FLUTES	ITEM #		1 PC	2 PC	3 PC	6 PC	9 PC	12 PC	24 PC	48 PC
				PLUG	BOTTOM								
<b>#10-24 NC</b>				<i>See Previous Page for Recommended Hole Size</i>									
TRU-FLO FORM TAP	10	PLATING		19054	19055	\$36.30	\$33.40	\$30.10	\$25.90	\$22.30	\$20.60	\$18.00	\$15.40
SOLID CARBIDE / HAND TAP	3	3B	4	41180	41181	\$69.20	\$69.20	\$69.20	\$69.20	\$69.20	\$60.80	\$59.40	\$58.00
SOLID CARBIDE / SP PT TAP	3	3B	2	41175		\$71.60	\$71.60	\$71.60	\$71.60	\$71.60	\$62.40	\$61.00	\$59.70
COST CUTTER DRILL/TAP	3	3B	2	29008		\$15.30	\$15.30	\$15.30	\$15.30	\$15.30	\$15.30	\$15.30	\$15.30
STI HAND TAP	2	3B	3	17818	17819	\$22.10	\$20.80	\$19.30	\$18.30	\$17.60	\$16.00	\$15.50	\$15.10
STI SPIRAL POINT TAP	2	3B	2	17820		\$23.50	\$22.20	\$20.60	\$19.70	\$19.00	\$17.20	\$16.90	\$16.50
STI HAND TAP	3	2B	3	17822	17823	\$22.10	\$20.80	\$19.30	\$18.30	\$17.60	\$16.00	\$15.50	\$15.10
STI SPIRAL POINT TAP	3	2B	2	17824		\$23.50	\$22.20	\$20.60	\$19.70	\$19.00	\$17.20	\$16.90	\$16.50
R.H. ROUND DIE 1"OD				13036		\$38.70	\$38.70	\$38.70	\$33.00	\$31.40	\$28.80	\$27.70	\$27.50
L.H. ROUND DIE 1"OD				13037		\$87.00	\$65.40	\$57.70	\$39.60	\$37.70	\$34.40	\$29.50	\$29.30
GAGE - Taperlock Style		2B		23078		\$112.20							
GAGE - Taperlock Style		3B		23079		\$112.20							
GAGE - Reversible Style		2B		24269		\$144.90							
GAGE - Reversible Style		3B		24270		\$144.90							
GAGE - Ring-Go		2A		23440		\$130.30							
GAGE - Ring-Go		3A		23441		\$130.30							
GAGE - Ring-NoGo		2A		23442		\$130.30							
GAGE - Ring-NoGo		3A		23443		\$130.30							
GAGE - STI Plug Taperlock		2B		24657		\$155.70							
GAGE - STI Plug Taperlock		3B		24658		\$155.70							
<b>#10-28 NS</b>				<i>Recommended Hole Size based on 75% Thread = .1553"</i>									
HAND TAP	3	3B	4	15266	15267	\$34.50	\$30.50	\$29.50	\$24.30	\$18.00	\$16.00	\$13.30	\$12.20
<b>#10-30 NS</b>				<i>Recommended Hole Size based on 75% Thread = .1574"</i>									
HAND TAP	3	3B	4	15272	15273	\$34.50	\$30.50	\$29.50	\$24.30	\$18.00	\$16.00	\$13.30	\$12.20
<b>#10-32 NF</b>				<i>Recommended Hole Size based on 75% Thread = .1597" for STI = .2031" / TRU-FLO at 65% Thread = .1762"</i>									
L.H. HAND TAP	3	2B	4	15278	15279	\$8.70	\$8.70	\$8.70	\$8.70	\$8.70	\$8.70	\$8.70	\$8.70
L.H. SPIRAL POINT TAP	3	2B	2	15276		\$17.20	\$17.20	\$17.20	\$17.20	\$17.20	\$17.20	\$14.40	\$13.40
HAND TAP	4		4	17898	17899	\$48.90	\$44.50	\$40.20	\$28.70	\$20.20	\$16.00	\$13.30	\$12.20
SPIRAL POINT TAP	4		2	15282		\$36.50	\$35.80	\$35.10	\$29.90	\$21.40	\$17.20	\$14.40	\$13.40
HAND TAP	5		4	15290	15291	\$34.60	\$30.50	\$29.50	\$24.30	\$20.20	\$16.00	\$13.30	\$12.20
SPIRAL POINT TAP	5		2	15288		\$36.50	\$35.80	\$35.10	\$29.90	\$21.40	\$17.20	\$14.40	\$13.40
+.003 HAND TAP	7		4	15296	15297	\$10.90	\$10.90	\$10.90	\$10.90	\$10.90	\$10.90	\$10.90	\$10.90
+.003 SPIRAL POINT TAP	7		2	15294		\$12.40	\$12.40	\$12.40	\$12.40	\$12.40	\$12.40	\$12.40	\$12.40
+.005 HAND TAP	11	PLATING	4	15302	15303	\$8.00	\$8.00	\$8.00	\$8.00	\$8.00	\$7.40	\$7.40	\$7.40
+.005 SPIRAL POINT TAP	11	PLATING	2	15300		\$9.20	\$9.20	\$9.20	\$9.20	\$9.20	\$7.90	\$7.90	\$7.90
4" EXTENSION SPIRAL POINT TAP	3	2B	2	17583		\$39.30	\$37.60	\$33.70	\$32.20	\$31.30	\$30.50	\$27.60	\$25.20
6" EXTENSION HAND TAP	3	2B	4	15314	15315	\$27.70	\$27.70	\$27.70	\$27.70	\$27.70	\$27.70	\$27.70	\$24.80
6" EXTENSION SPIRAL POINT TAP	3	2B	2	15312		\$29.00	\$29.00	\$29.00	\$29.00	\$29.00	\$29.00	\$29.00	\$26.20
TRU-FLO FORM TAP	4	3B		19056	19057	\$36.30	\$33.40	\$30.10	\$25.90	\$22.30	\$20.60	\$18.00	\$15.40
TRU-FLO FORM TAP	6	2B		19058	19059	\$36.30	\$33.40	\$30.10	\$25.90	\$22.30	\$20.60	\$18.00	\$15.40
TRU-FLO FORM TAP	10	PLATING		19060	19061	\$36.30	\$33.40	\$30.10	\$25.90	\$22.30	\$20.60	\$18.00	\$15.40
SOLID CARBIDE / HAND TAP	3	2B	4	41213	41214	\$69.20	\$69.20	\$69.20	\$69.20	\$69.20	\$60.80	\$59.40	\$58.00
SOLID CARBIDE / SP PT TAP	3	2B	2	41208		\$71.60	\$71.60	\$71.60	\$71.60	\$71.60	\$62.40	\$61.00	\$59.70
COST CUTTER DRILL/TAP	3	2B	2	29009		\$15.30	\$15.30	\$15.30	\$15.30	\$15.30	\$15.30	\$15.30	\$15.30
TiN COAT/SP PT x 4" TAP	3	2B	2	50025		\$43.70	\$42.00	\$38.10	\$36.60	\$35.70	\$34.80	\$32.00	\$29.60



Click on Item Number for Catalog Listing

SIZE/ DESCRIPTION	GH #	CLASS OF FIT	# FLUTES	ITEM #		1 PC	2 PC	3 PC	6 PC	9 PC	12 PC	24 PC	48 PC
				PLUG	BOTTOM								
<b>#10-32 NF</b>				<i>See Previous Page for Recommended Hole Size</i>									
TiN COAT/SP PT TAP	4		2	50001		\$39.60	\$38.80	\$38.10	\$33.00	\$24.40	\$20.20	\$17.40	\$16.50
TiN COAT/SP PT TAP	5		2	50002		\$39.60	\$38.80	\$38.10	\$33.00	\$24.40	\$20.20	\$17.40	\$16.50
TiN COAT/SP PT+.005 TAP	11	PLATING	2	50003		\$12.30	\$12.30	\$12.30	\$12.30	\$12.30	\$10.90	\$10.90	\$10.90
STI HAND TAP	2	3B	3	17826	17827	\$22.10	\$20.80	\$19.30	\$18.30	\$17.60	\$16.00	\$15.50	\$15.10
STI SPIRAL POINT TAP	2	3B	2	17828		\$23.50	\$22.20	\$20.60	\$19.70	\$19.00	\$17.20	\$16.90	\$16.50
STI HAND TAP	3	2B	3	17830	17831	\$22.10	\$20.80	\$19.30	\$18.30	\$17.60	\$16.00	\$15.50	\$15.10
STI SPIRAL POINT TAP	3	2B	2	17832		\$23.50	\$22.20	\$20.60	\$19.70	\$19.00	\$17.20	\$16.90	\$16.50
R.H. ROUND DIE 1"OD				13038		\$38.70	\$38.70	\$38.70	\$33.00	\$31.40	\$28.80	\$27.70	\$27.50
L.H. ROUND DIE 1"OD				13039		\$87.00	\$65.40	\$57.70	\$39.60	\$37.70	\$34.40	\$29.50	\$29.30
GAGE - Taperlock Style		2B		23083		\$112.20							
GAGE - Taperlock Style		3B		23084		\$112.20							
GAGE - Reversible Style		2B		24274		\$144.90							
GAGE - Reversible Style		3B		24275		\$144.90							
GAGE - Ring-Go		2A		23446		\$130.30							
GAGE - Ring-Go		3A		23447		\$130.30							
GAGE - Ring-NoGo		2A		23448		\$130.30							
GAGE - Ring-NoGo		3A		23449		\$130.30							
GAGE - STI Plug Taperlock Style		2B		24662		\$155.70							
GAGE - STI Plug Taperlock Style		3B		24663		\$155.70							
<b>#10-36 NS</b>				<i>Recommended Hole Size based on 75% Thread = .163"</i>									
HAND TAP	2	3B	4	15320	15321	\$33.60	\$33.00	\$30.30	\$25.20	\$18.50	\$16.00	\$13.30	\$12.20
R.H. ROUND DIE 1"OD				13040		\$87.00	\$65.40	\$57.70	\$39.60	\$37.70	\$34.40	\$29.50	\$29.30
<b>#10-40 NS</b>				<i>Recommended Hole Size based on 75% Thread = .1658"</i>									
HAND TAP	2	3B	4	15326	15327	\$33.60	\$33.00	\$30.30	\$25.20	\$18.50	\$16.00	\$13.30	\$12.20
SPIRAL POINT TAP	2	3B	2	15324		\$36.60	\$35.90	\$33.00	\$27.40	\$20.20	\$17.20	\$14.40	\$13.40
R.H. ROUND DIE 1"OD				13042		\$87.00	\$65.40	\$57.70	\$39.60	\$37.70	\$34.40	\$29.50	\$29.30
<b>#10-48 NS</b>				<i>Recommended Hole Size based on 75% Thread = .1700"</i>									
HAND TAP	2	3B	4	15332	15333	\$33.60	\$33.00	\$30.30	\$25.20	\$18.50	\$16.00	\$13.30	\$12.20
<b>#10-56 NS</b>				<i>Recommended Hole Size based on 75% Thread = .1729"</i>									
HAND TAP	2	3B	4	15338	15339	\$33.60	\$33.00	\$30.30	\$25.20	\$18.50	\$16.00	\$13.30	\$12.20
R.H. ROUND DIE 1"OD				13046		\$87.00	\$65.40	\$57.70	\$39.60	\$37.70	\$34.40	\$29.50	\$29.30
<b>#10-64 NS</b>				<i>Recommended Hole Size based on 75% Thread = .1749"</i>									
HAND TAP	2	3B	4	15344	15345	\$33.60	\$33.00	\$30.30	\$25.20	\$18.50	\$16.00	\$13.30	\$12.20
<b>.210"-36 NS</b>				<i>Recommended Hole Size based on 75% Thread = .183"</i>									
HAND TAP	3	3B	4	17646	17647	\$43.00	\$37.80	\$36.50	\$30.10	\$22.90	\$20.80	\$18.20	\$15.60
HAND TAP	4	2B	4	17901	17902	\$43.00	\$37.80	\$36.50	\$30.10	\$22.90	\$20.80	\$18.20	\$15.60
<b>#12-24 NC</b>				<i>Recommended Hole Size based on 75% Thread = .175" TRU-FLO at 65% Thread = .1976"</i>									
L.H. HAND TAP	3	3B	4	15374	15375	\$35.60	\$34.80	\$31.90	\$26.70	\$19.50	\$18.00	\$14.30	\$13.30
TRU-FLO FORM TAP	4	3B		19062	19063	\$38.40	\$34.40	\$32.20	\$28.00	\$24.40	\$22.70	\$20.10	\$17.50
TRU-FLO FORM TAP	6	2B		19064	19065	\$38.40	\$34.40	\$32.20	\$28.00	\$24.40	\$22.70	\$20.10	\$17.50
SOLID CARBIDE / HAND TAP	3	3B	4	41246	41247	\$70.50	\$70.50	\$70.50	\$70.50	\$70.50	\$62.00	\$60.60	\$59.30
SOLID CARBIDE / SP PT TAP	3	3B	2	41241		\$72.90	\$72.90	\$72.90	\$72.90	\$72.90	\$63.60	\$62.20	\$60.90
COST CUTTER DRILL/TAP	3	3B	2	29010		\$15.30	\$15.30	\$15.30	\$15.30	\$15.30	\$15.30	\$15.30	\$15.30
L.H. ROUND DIE 1"OD				13049		\$87.00	\$65.40	\$57.70	\$39.60	\$37.70	\$34.40	\$29.50	\$29.30
GAGE - Taperlock Style		2B		23088		\$112.20							

TAPS, DIES & GAGES

Click on Item Number for Catalog Listing

SIZE/ DESCRIPTION	GH #	CLASS OF FIT	# FLUTES	ITEM #		1 PC	2 PC	3 PC	6 PC	9 PC	12 PC	24 PC	48 PC
				PLUG	BOTTOM								
<b>#12-24 NC</b>													
<i>See Previous Page for Recommended Hole Size</i>													
GAGE - Taperlock Style		3B		23089		\$112.20							
GAGE - Reversible Style		2B		24279		\$144.90							
GAGE - Reversible Style		3B		24280		\$144.90							
GAGE - Ring-Go		2A		23452		\$130.30							
GAGE - Ring-Go		3A		23453		\$130.30							
GAGE - Ring-NoGo		2A		23454		\$130.30							
GAGE - Ring-NoGo		3A		23455		\$130.30							
GAGE - STI Plug Taperlock Style		2B		24667		\$155.70							
GAGE - STI Plug Taperlock Style		3B		24668		\$155.70							
<b>#12-28 NF</b>													
<i>Recommended Hole Size based on 75% Thread = .1813" TRU-FLO at 65% Thread = .2002"</i>													
L.H. HAND TAP	3	3B	4	15380	15381	\$35.60	\$34.80	\$31.90	\$26.70	\$19.50	\$18.00	\$14.30	\$13.30
TRU-FLO FORM TAP	4	3B		19066	19067	\$38.40	\$34.40	\$32.20	\$28.00	\$24.40	\$22.70	\$20.10	\$17.50
TRU-FLO FORM TAP	6	2B		19068	19069	\$38.40	\$34.40	\$32.20	\$28.00	\$24.40	\$22.70	\$20.10	\$17.50
SOLID CARBIDE / HAND TAP	3	3B	4	41279	41280	\$70.50	\$70.50	\$70.50	\$70.50	\$70.50	\$62.00	\$60.60	\$59.30
SOLID CARBIDE / SP PT TAP	3	3B	2	41274		\$72.90	\$72.90	\$72.90	\$72.90	\$72.90	\$63.60	\$62.20	\$60.90
L.H. ROUND DIE 1"OD				13051		\$87.00	\$65.40	\$57.70	\$39.60	\$37.70	\$34.40	\$29.50	\$29.30
GAGE - Taperlock Style		2B		23093		\$112.20							
GAGE - Taperlock Style		3B		23094		\$112.20							
GAGE - Reversible Style		2B		24284		\$144.90							
GAGE - Reversible Style		3B		24285		\$144.90							
GAGE - Ring-Go		2A		23458		\$130.30							
GAGE - Ring-Go		3A		23459		\$130.30							
GAGE - Ring-NoGo		2A		23460		\$130.30							
GAGE - Ring-NoGo		3A		23461		\$130.30							
<b>#12-32 NEF</b>													
<i>Recommended Hole Size based on 75% Thread = .1857"</i>													
HAND TAP	3	3B	4	15386	15387	\$15.80	\$15.80	\$15.80	\$9.70	\$8.40	\$8.40	\$8.40	\$8.40
SPIRAL POINT TAP	3	3B	2	15384		\$17.20	\$17.20	\$17.20	\$17.20	\$17.20	\$16.10	\$15.10	\$13.40
R.H. ROUND DIE 1"OD				13052		\$87.00	\$65.40	\$57.70	\$39.60	\$37.70	\$34.40	\$29.50	\$29.30
GAGE - Taperlock Style		2B		23098		\$170.10							
GAGE - Taperlock Style		3B		23099		\$170.10							
GAGE - Reversible Style		2B		22144		\$160.10							
GAGE - Reversible Style		3B		22145		\$195.50							
GAGE - Ring-Go		2A		23464		\$180.80							
GAGE - Ring-Go		3A		23465		\$180.80							
GAGE - Ring-NoGo		2A		23466		\$180.80							
GAGE - Ring-NoGo		3A		23467		\$180.80							
<b>#12-36 NS</b>													
<i>Recommended Hole Size based on 75% Thread = .189"</i>													
HAND TAP	2	3B	4	15392	15393	\$35.00	\$28.10	\$23.80	\$22.00	\$20.20	\$18.00	\$14.30	\$13.30
R.H. ROUND DIE 1"OD				13054		\$87.00	\$65.40	\$57.70	\$39.60	\$37.70	\$34.40	\$29.50	\$29.30
<b>#14-20 NS</b>													
<i>Recommended Hole Size based on 75% Thread = .1935"</i>													
HAND TAP	3	3B	4	15398	15399	\$39.20	\$38.40	\$35.30	\$29.50	\$21.70	\$18.30	\$15.60	\$14.30
<b>#14-24 NS</b>													
<i>Recommended Hole Size based on 75% Thread = .201"</i>													
HAND TAP	3	3B	4	15404	15405	\$39.20	\$38.40	\$35.30	\$29.50	\$21.70	\$18.30	\$15.60	\$14.30
R.H. ROUND DIE 1"OD				13060		\$87.00	\$65.40	\$57.70	\$39.60	\$37.70	\$34.40	\$29.50	\$29.30





Click on Item Number for Catalog Listing

SIZE/ DESCRIPTION	GH #	CLASS OF FIT	# FLUTES	ITEM #		1 PC	2 PC	3 PC	6 PC	9 PC	12 PC	24 PC	48 PC
				PLUG	BOTTOM								
<b>1/16"-27 PIPE TAP</b>				<i>Recommended Hole Size: NPT/NPTF = .246"</i>									
<b>NPSI NPSF NPT/F NPS</b>													
NPT/F LEFT HAND TAPER TAP			4	15407		\$33.50	\$33.00	\$32.10	\$26.80	\$20.20	\$16.80	\$16.10	\$15.40
NPT/F INT. THD TAP			5	17677		\$89.90	\$59.90	\$49.90	\$36.40	\$31.00	\$27.50	\$25.10	\$23.00
NPT/F 4" EXTENSION TAPER TAP			4	17665		\$62.50	\$61.60	\$60.00	\$50.00	\$42.50	\$35.90	\$31.60	\$29.30
NPT/F 6" EXTENSION TAPER TAP			4	15410		\$137.10	\$79.30	\$77.30	\$64.50	\$48.30	\$40.30	\$38.70	\$33.80
SOLID CARBIDE - NPT/F TAP			4	41800		\$143.60	\$143.60	\$143.60	\$130.80	\$123.10	\$118.60	\$112.80	\$110.00
NPT/F COST CUTTER DRILL/TAP			4	29040		\$63.80	\$61.00	\$59.80	\$58.20	\$46.70	\$38.50	\$33.90	\$30.20
NPS R.H. ROUND DIE 1"OD				13064		\$103.40	\$83.80	\$60.70	\$44.70				
GAGE L1 NPT PLG w/handle				24368		\$102.40							
GAGE L1 NPT RING				24366		\$194.20							
GAGE L1 NPTF PLG w/handle				24418		\$143.10							
GAGE L3 NPTF PLG w/handle				24420		\$143.10							
GAGE NPTF 6 step Plain Plug w/handle				24524		\$201.20							
GAGE L1 NPTF RING				24486		\$201.20							
GAGE L2 NPTF RING				24488		\$282.60							
GAGE NPTF 6 step Plain Ring				24558		\$326.50							
<b>1/8"-27 PIPE TAP</b>				<i>Recommended Drill Size: NPT/NPTF = .332" NPSF/NPSI = .3438"</i>									
<b>NPSI NPSF NPT/F NPS</b>													
NPT/F REG SPR FLT TAPER TAP			4	17554		\$51.20	\$47.50	\$44.40	\$35.70	\$32.30	\$30.70	\$28.20	\$25.70
NPT/F LEFT HAND TAPER TAP			4	15413		\$35.30	\$34.80	\$33.90	\$32.00	\$30.10	\$27.50	\$25.80	\$23.50
NPT/F 4" EXTENSION TAPER TAP			4	15416		\$46.00	\$46.00	\$46.00	\$46.00	\$37.10	\$32.50	\$30.80	\$28.30
NPT/F 6" EXTENSION TAPER TAP			4	15419		\$41.00	\$41.00	\$41.00	\$41.00	\$32.10	\$27.50	\$25.80	\$23.30
NPT/F 6" EXTENSION INT TAPER TAP			5	15422		\$47.30	\$47.30	\$47.30	\$47.30	\$40.70	\$35.60	\$31.60	\$27.90
NPSF EXT x 6" TAP			4	17710		\$60.30	\$56.70	\$53.00	\$50.40	\$47.80	\$46.50	\$44.60	\$40.90
NPT/F 8" EXTENSION TAPER TAP			4	17956		\$50.30	\$47.50	\$44.60	\$42.10	\$38.70	\$37.10	\$34.60	\$32.10
NPT/F 10" EXTENSION TAPER TAP			4	17959		\$54.30	\$51.50	\$48.60	\$46.10	\$42.70	\$41.10	\$38.60	\$36.10
NPT/F 12 EXT TAPER TAP			4	17962		\$59.30	\$56.50	\$53.60	\$51.10	\$47.70	\$46.10	\$43.60	\$41.10
NPSI STRAIGHT TAP			4	15431		\$39.40	\$38.80	\$37.80	\$31.50	\$23.70	\$22.80	\$19.10	\$17.10
SOLID CARBIDE - NPT/F TAP			4	41801		\$182.90	\$182.90	\$182.90	\$182.90	\$177.00	\$172.90	\$166.90	\$164.00
SOLID CARBIDE - NPSF TAP			4	41807		\$153.90	\$153.90	\$153.90	\$153.90	\$148.70	\$144.70	\$138.70	\$135.70
TiN COAT / INT. x 6" NPT/F TAP			5	50004		\$48.00	\$48.00	\$48.00	\$48.00	\$39.10	\$34.50	\$32.80	\$30.30
NPT/F COST CUTTER DRILL/TAP			4	29041		\$75.30	\$71.80	\$70.60	\$68.40	\$57.60	\$48.80	\$44.40	\$40.70
NPT R.H. ROUND DIE 1"OD				13070		\$83.20	\$62.50	\$55.20	\$43.30	\$41.50	\$38.10	\$32.20	\$31.80
NPS R.H. ROUND DIE 1"OD				13072		\$103.40	\$83.80	\$60.70	\$44.70				
GAGE L1 NPT PLG w/handle				24371		\$72.60							
GAGE L1 NPT RING				24369		\$132.50							
GAGE L1 NPTF PLG w/handle				24426		\$102.40							
GAGE L3 NPTF PLG w/handle				24428		\$102.40							
GAGE NPTF 6 step Plain Plug w/handle				24528		\$201.30							
GAGE L1 NPTF RING				24490		\$141.40							
GAGE L2 NPTF RING				24492		\$271.80							
GAGE NPTF 6 step Plain Ring				24562		\$326.50							



TAPS, DIES & GAGES

Click on Item Number for Catalog Listing

SIZE/ DESCRIPTION	GH #	CLASS OF FIT	# FLUTES	ITEM #		1 PC	2 PC	3 PC	6 PC	9 PC	12 PC	24 PC	48 PC
				PLUG	BOTTOM								
<b>1/8"-28 55° WHITWORTH PIPE</b>													
<i>Recommended Hole size BSPT = .3281" / BSPP = .3438"</i>													
BSPT TAPER - MODIFIED TAP			4	15434	15435	\$43.50	\$33.10	\$29.80	\$27.20	\$26.10	\$23.50	\$23.20	\$22.80
BSPP PARALLEL - MODIFIED TAP			4	15437	15438	\$43.50	\$33.10	\$29.80	\$27.20	\$26.10	\$23.50	\$23.20	\$22.80
BSPT TAPER - FULL FORM TAP			4	17932		\$59.90	\$54.80	\$51.90	\$50.00	\$48.50	\$46.90	\$44.30	\$43.10
BSPP PARALLEL - FULL FORM TAP			4	17923		\$59.90	\$54.80	\$51.90	\$50.00	\$48.50	\$46.90	\$44.30	\$43.10
BSPT R.H. ROUND DIE 1"OD				13692		\$209.70							
BSPP R.H. ROUND DIE 1"OD				13693		\$69.00							
GAGE BSPP-Mod. DBL END w/handle				27041		\$324.70							
GAGE BSPT-Mod. w/handle				27002		\$264.60							
<b>5/32"-32 NS</b>													
<i>Recommended Hole Size based on 75% Thread = .1259"</i>													
HAND TAP	3	2B	4	17560	17561	\$61.70	\$59.60	\$49.50	\$30.60	\$21.80	\$17.80	\$13.80	\$13.40
<b>3/16"-24 NS</b>													
<i>Recommended Hole Size based on 75% Thread = .1465"</i>													
HAND TAP	3	3B	4	15443	15444	\$35.60	\$34.80	\$31.90	\$26.70	\$19.50	\$18.00	\$14.30	\$13.30
<b>3/16"-32 NS</b>													
<i>Recommended Hole Size based on 75% Thread = .1572"</i>													
HAND TAP	3	2B	4	15449	15450	\$35.60	\$34.80	\$31.90	\$26.70	\$19.50	\$18.00	\$14.30	\$13.30
<b>7/32"-32 NS</b>													
<i>Recommended Hole Size based on 75% Thread = .1884"</i>													
HAND TAP	3	2B	4	17565	17566	\$61.70	\$59.60	\$49.50	\$30.60	\$21.80	\$17.80	\$13.80	\$13.40
<b>1/4"-18 PIPE TAP NPSI NPSF NPT/F NPS</b>													
<i>Recommended Hole Size: NPT/NPTF = .4375" NPSF / NPSI = .4375"</i>													
NPT/F REG. SPR FLT TAPER TAP			4	15452		\$46.60	\$46.60	\$46.60	\$46.60	\$46.60	\$46.60	\$46.60	\$46.60
NPT/F LEFT HAND TAPER TAP			4	15455		\$46.20	\$45.60	\$44.40	\$36.90	\$27.80	\$27.80	\$27.80	\$27.80
PTF-SAE SHORT PROJ .361 TAP			4	17689	17690	\$47.30	\$43.20	\$41.70	\$35.50	\$31.90	\$30.30	\$27.60	\$25.00
NPT/F 4" EXTENSION TAPER TAP			4	15458		\$61.90	\$61.90	\$61.90	\$61.90	\$61.90	\$54.80	\$48.60	\$43.00
NPT/F 6" EXTENSION TAPER TAP			4	15461		\$53.70	\$53.70	\$53.70	\$53.70	\$42.20	\$33.90	\$28.50	\$27.70
NPT/F 6 INT EXT TAPER TAP			5	15464		\$59.60	\$59.60	\$59.60	\$59.60	\$46.60	\$39.30	\$35.70	\$33.00
NPT/F 8" EXTENSION TAPER TAP			4	15467		\$51.80	\$51.80	\$51.80	\$51.80	\$51.80	\$45.30	\$37.60	\$37.60
NPSF EXT x 6" TAP			4	17703		\$67.50	\$63.20	\$59.60	\$57.20	\$56.40	\$54.70	\$52.30	\$46.70
NPSI STRAIGHT TAP			4	15476		\$54.10	\$53.30	\$52.00	\$43.20	\$32.50	\$27.10	\$26.00	\$24.10
SOLID CARBIDE - NPT/F TAP			4	41802		\$249.70	\$249.70	\$249.70	\$249.70	\$238.40	\$220.50	\$214.10	\$211.10
TiN COAT x 6" NPT/F TAP			4	50005		\$66.80	\$66.80	\$66.80	\$66.80	\$55.30	\$47.10	\$41.60	\$40.90
TiN COAT / INT. x 6" NPT/F TAP			5	50006		\$72.80	\$72.80	\$72.80	\$72.80	\$59.70	\$52.50	\$48.90	\$46.10
NPT/F COST CUTTER DRILL/TAP			4	29042		\$92.10	\$89.60	\$87.40	\$86.50	\$83.90	\$80.40	\$75.50	\$71.40
NPT R.H. ROUND DIE 1-1/2"OD				13092		\$106.10	\$81.90	\$76.00	\$64.90	\$62.10	\$56.90	\$51.40	\$51.20
NPS R.H. ROUND DIE 1-1/2"OD				13094		\$108.10	\$87.60	\$63.50	\$46.80				
GAGE L1 NPT PLG w/handle				24374		\$88.70							
GAGE L1 NPT RING				24372		\$151.40							
GAGE L1 NPTF PLG w/handle				24434		\$125.40							
GAGE L3 NPTF PLG w/handle				24436		\$125.40							
GAGE NPTF 6 step Plain Plug w/handle				24532		\$210.30							
GAGE L1 NPTF RING				24494		\$173.50							
GAGE L2 NPTF RING				24496		\$295.40							
GAGE NPTF 6 step Plain Ring				24566		\$341.20							



Click on Item Number for Catalog Listing

SIZE/ DESCRIPTION	GH #	CLASS OF FIT	# FLUTES	ITEM #		1 PC	2 PC	3 PC	6 PC	9 PC	12 PC	24 PC	48 PC
				PLUG	BOTTOM								
<b>1/4"-19 55° WHITWORTH PIPE</b>				<i>Recommended Hole Size: BSPT = .4375" / BSPP = .4531"</i>									
BSPT TAPER - MODIFIED TAP			4	15479	15480	\$31.50	\$31.50	\$31.50	\$28.80	\$28.50	\$27.50	\$26.80	\$26.00
BSPP PARALLEL - MODIFIED TAP			4	15482	15483	\$31.50	\$31.50	\$31.50	\$28.80	\$28.50	\$27.50	\$26.80	\$26.00
BSPT TAPER - FULL FORM TAP			4	17933		\$65.20	\$60.00	\$57.00	\$54.40	\$53.60	\$51.90	\$49.30	\$46.70
BSPP PARALLEL - FULL FORM TAP			4	17924		\$65.20	\$60.00	\$57.00	\$54.40	\$53.60	\$51.90	\$49.30	\$46.70
BSPT R.H. ROUND DIE 1-1/2"OD				13694		\$341.20							
BSPP R.H. ROUND DIE 1-1/2"OD				13695		\$120.60							
GAGE BSPP-Mod. DBL END w/handle				27044		\$326.90							
GAGE BSPT-Mod. w/handle				27005		\$292.10							
<b>1/4"-20 NC</b>				<i>Recommended Hole Size based on 75% Thread = .2015" for STI = .2660" / TRU-Flo at 65% Thread = .2279"</i>									
FAST SPIRAL FLUTE TAP	5	2B	3	17766	17767	\$82.90	\$51.60	\$41.10	\$30.70	\$27.10	\$25.40	\$22.80	\$20.20
L.H. HAND TAP	3	3B	4	15488	15489	\$9.70	\$9.70	\$9.70	\$9.70	\$9.70	\$8.90	\$8.90	\$8.90
L.H. SPIRAL POINT TAP	3	3B	2	15486		\$24.20	\$24.20	\$24.20	\$24.20	\$24.20	\$20.00	\$15.80	\$14.60
+ .003 HAND TAP	7		4	15494	15495	\$35.20	\$35.20	\$35.20	\$30.10	\$21.80	\$17.90	\$13.80	\$12.70
+ .003 SPIRAL POINT TAP	7		2	15492		\$37.50	\$37.50	\$37.50	\$31.50	\$23.20	\$19.10	\$15.20	\$14.20
+ .005 HAND TAP	11	PLATING	4	15500	15501	\$10.10	\$10.10	\$10.10	\$10.10	\$10.10	\$10.10	\$10.10	\$10.10
+ .005 SPIRAL POINT TAP	11	PLATING	2	15498		\$11.30	\$11.30	\$11.30	\$11.30	\$11.30	\$11.30	\$11.30	\$11.30
+ .010 HAND TAP	21		4	15506	15507	\$33.00	\$32.20	\$31.60	\$26.40	\$21.10	\$19.10	\$15.20	\$14.20
DOUBLE LEAD TAP	3	3B	4	15512	15513	\$44.80	\$44.10	\$43.00	\$35.90	\$26.90	\$22.40	\$20.60	\$18.30
4" EXTENSION SP PT SM SHK TAP	3	3B	2	17964		\$42.30	\$40.50	\$36.40	\$35.10	\$34.30	\$33.40	\$32.80	\$31.50
4" EXTENSION SPIRAL POINT TAP	3	3B	2	17584		\$39.70	\$37.90	\$33.80	\$32.50	\$31.80	\$31.30	\$28.10	\$25.90
6" EXTENSION HAND TAP	3	3B	4	15518	15519	\$23.70	\$23.70	\$23.70	\$23.70	\$23.70	\$23.70	\$23.70	\$23.70
6" EXTENSION SM SHK HAND TAP	3	3B	4	17570	17571	\$38.70	\$38.70	\$38.70	\$37.30	\$34.60	\$33.00	\$30.40	\$27.70
6" EXTENSION SPIRAL POINT TAP	3	3B	2	15516		\$25.40	\$25.40	\$25.40	\$25.40	\$25.40	\$25.40	\$25.40	\$24.40
6" EXTENSION SP PT SM SHK TAP	3	3B	2	17569		\$38.70	\$38.70	\$38.70	\$37.30	\$34.60	\$33.00	\$30.40	\$27.70
8" EXTENSION HAND TAP	3	3B	4	15524	15525	\$28.80	\$28.80	\$28.80	\$28.80	\$28.80	\$28.80	\$28.80	\$27.00
TRU-FLO FORM TAP	4	3B		19070	19071	\$39.00	\$35.10	\$32.90	\$28.60	\$25.00	\$23.40	\$20.70	\$18.10
TRU-FLO FORM TAP	6	2B		19072	19073	\$39.00	\$35.10	\$32.90	\$28.60	\$25.00	\$23.40	\$20.70	\$18.10
TRU-FLO FORM TAP	10	PLATING		19074	19075	\$39.00	\$35.10	\$32.90	\$28.60	\$25.00	\$23.40	\$20.70	\$18.10
SOLID CARBIDE / HAND TAP	3	3B	4	41312	41313	\$78.90	\$78.90	\$78.90	\$78.90	\$78.90	\$69.30	\$67.30	\$65.70
SOLID CARBIDE / SP PT TAP	3	3B	2	41307		\$81.40	\$81.40	\$81.40	\$81.40	\$81.40	\$71.00	\$68.90	\$67.30
COST CUTTER DRILL/TAP	3	3B	2	29012		\$15.30	\$15.30	\$15.30	\$15.30	\$15.30	\$15.30	\$15.30	\$15.30
TIN COAT/SP PT+.003 TAP	7		2	50007		\$40.50	\$40.50	\$40.50	\$34.50	\$26.30	\$22.10	\$18.20	\$17.20
TiN COAT/SP PT+.005 TAP	11	PLATING	2	50008		\$14.40	\$14.40	\$14.40	\$14.40	\$14.40	\$14.40	\$14.40	\$14.40
TiN COAT/SP PT x 6" TAP	3	3B	2	50009		\$31.10	\$31.10	\$31.10	\$31.10	\$31.10	\$31.10	\$31.10	\$30.00
TiN COAT/SP PT x 6"/SM SHK TAP	3	3B	2	50023		\$44.40	\$44.40	\$44.40	\$42.90	\$40.30	\$38.60	\$36.00	\$33.40
TiN COAT/SP PT x 4" TAP	3	3B	2	50026		\$44.00	\$42.30	\$38.20	\$36.90	\$36.20	\$35.70	\$32.40	\$30.30
STI HAND TAP	2	3B	3	17834	17835	\$22.40	\$21.20	\$19.60	\$18.70	\$17.90	\$16.40	\$15.80	\$15.40
STI SPIRAL POINT TAP	2	3B	2	17836		\$23.90	\$22.60	\$21.10	\$20.10	\$19.40	\$17.80	\$17.30	\$16.90
STI HAND TAP	3	2B	3	17838	17839	\$22.40	\$21.20	\$19.60	\$18.70	\$17.90	\$16.40	\$15.80	\$15.40

TAPS, DIES & GAGES

Click on Item Number for Catalog Listing

SIZE/ DESCRIPTION	GH #	CLASS OF FIT	# FLUTES	ITEM #		1 PC	2 PC	3 PC	6 PC	9 PC	12 PC	24 PC	48 PC
				PLUG	BOTTOM								
<b>1/4"-20 NC</b>				<i>See Previous Page for Recommended Hole Size</i>									
STI SPIRAL POINT TAP	3	2B	2	17840		\$23.90	\$22.60	\$21.10	\$20.10	\$19.40	\$17.80	\$17.30	\$16.90
R.H. ROUND DIE 1"OD				13074		\$38.70	\$38.70	\$38.70	\$33.00	\$31.40	\$28.80	\$27.70	\$27.50
L.H. ROUND DIE 1"OD				13075		\$87.00	\$65.40	\$57.70	\$39.60	\$37.70	\$34.40	\$29.50	\$29.30
GAGE - Taperlock Style		2B		23103		\$92.40							
GAGE - Taperlock Style		3B		23104		\$92.40							
GAGE - Reversible Style		2B		24289		\$134.00							
GAGE - Reversible Style		3B		24290		\$134.00							
GAGE - Ring-Go		2A		23470		\$121.20							
GAGE - Ring-Go		3A		23471		\$121.20							
GAGE - Ring-NoGo		2A		23472		\$121.20							
GAGE - Ring-NoGo		3A		23473		\$121.20							
GAGE - STI Plug Taperlock Style		2B		24677		\$146.60							
GAGE - STI Plug Taperlock Style		3B		24678		\$146.60							
<b>1/4"-20 BSW 55° MOD WHITWORTH</b>				<i>Recommended Hole Size = .2020"</i>									
	3		4	15530	15531	\$72.40	\$72.40	\$72.40	\$60.00	\$47.80	\$35.50	\$28.20	\$25.30
<b>1/4"-24 NS</b>				<i>Recommended Hole Size based on 75% Thread = .209"</i>									
HAND TAP	3	3B	4	15536	15537	\$24.30	\$24.00	\$23.40	\$19.50	\$15.30	\$12.70	\$12.20	\$10.80
SPIRAL POINT TAP	3	3B	2	15534		\$27.00	\$26.60	\$25.90	\$21.50	\$16.60	\$14.30	\$13.50	\$12.20
R.H. ROUND DIE 1"OD				13076		\$87.00	\$65.40	\$57.70	\$39.60	\$37.70	\$34.40	\$29.50	\$29.30
<b>1/4"-26 BSF 55° MOD WHITWORTH</b>				<i>Recommended Hole Size = .2130"</i>									
	3		4	17620	17621	\$72.40	\$72.40	\$72.40	\$60.00	\$47.80	\$35.50	\$28.20	\$25.30
<b>1/4"-27 NS</b>				<i>Recommended Hole Size based on 75% Thread = .214"</i>									
HAND TAP	3	3B	4	15542	15543	\$24.30	\$24.00	\$23.40	\$19.50	\$15.30	\$12.70	\$12.20	\$10.80
R.H. ROUND DIE 1"OD				13078		\$87.00	\$65.40	\$57.70	\$39.60	\$37.70	\$34.40	\$29.50	\$29.30
<b>1/4"-28 NF</b>				<i>Recommended Hole Size based on 75% Thread = .2153" for STI = .2638" / TRU-FLO at 65% Thread = .2342"</i>									
L.H. HAND TAP	3	3B	4	15548	15549	\$9.70	\$9.70	\$9.70	\$9.70	\$9.70	\$8.90	\$8.90	\$8.90
L.H. SPIRAL POINT TAP	3	3B	2	15546		\$18.00	\$18.00	\$18.00	\$18.00	\$18.00	\$18.00	\$16.70	\$15.40
HAND TAP	5		4	15554	15555	\$31.70	\$31.00	\$30.50	\$25.30	\$19.10	\$15.80	\$13.80	\$12.70
SPIRAL POINT TAP	5		2	15552		\$33.30	\$32.50	\$31.90	\$26.70	\$19.90	\$16.70	\$15.20	\$14.20
+.003 HAND TAP	7		4	15560	15561	\$31.80	\$31.20	\$30.70	\$25.40	\$21.80	\$17.90	\$13.80	\$12.70
+.003 SPIRAL POINT TAP	7		2	15558		\$33.30	\$32.70	\$31.90	\$26.70	\$23.20	\$19.10	\$15.20	\$14.20
+.005 HAND TAP	11	PLATING	4	15566	15567	\$10.10	\$10.10	\$10.10	\$10.10	\$10.10	\$9.10	\$9.10	\$9.10
+.005 SPIRAL POINT TAP	11	PLATING	2	15564		\$11.30	\$11.30	\$11.30	\$11.30	\$11.30	\$10.50	\$10.50	\$10.50
DOUBLE LEAD TAP	3	3B	4	15572	15573	\$44.80	\$44.10	\$43.00	\$35.90	\$26.90	\$22.40	\$20.60	\$18.30
4" EXTENSION SP PT SM SHK TAP	3	3B	2	17965		\$42.30	\$40.50	\$36.40	\$35.10	\$34.30	\$33.40	\$32.80	\$31.50
6" EXTENSION HAND TAP	3	3B	4	15578	15579	\$23.70	\$23.70	\$23.70	\$23.70	\$23.70	\$23.70	\$23.70	\$23.70
6" EXTENSION SPIRAL POINT TAP	3	3B	2	15576		\$26.30	\$26.30	\$26.30	\$26.30	\$26.30	\$26.30	\$26.30	\$26.30
6" EXTENSION SP PT SM SHK TAP	3	3B	2	17607		\$40.00	\$38.70	\$37.00	\$35.40	\$31.80	\$30.10	\$27.50	\$24.90
TRU-FLO FORM TAP	4	3B		19076	19077	\$39.00	\$35.10	\$32.90	\$28.60	\$25.00	\$23.40	\$20.70	\$18.10
TRU-FLO FORM TAP	6	2B		19078	19079	\$39.00	\$35.10	\$32.90	\$28.60	\$25.00	\$23.40	\$20.70	\$18.10



Click on Item Number for Catalog Listing

SIZE / DESCRIPTION	GH #	CLASS OF FIT	# FLUTES	ITEM #		1 PC	2 PC	3 PC	6 PC	9 PC	12 PC	24 PC	48 PC
				PLUG	BOTTOM								
<b>1/4"-28 NF</b>				<i>See Previous Page for Recommended Hole Size</i>									
TRU-FLO FORM TAP	10	PLATING		19080	19081	\$39.00	\$35.10	\$32.90	\$28.60	\$25.00	\$23.40	\$20.70	\$18.10
SOLID CARBIDE / HAND TAP	3	3B	4	41345	41346	\$78.90	\$78.90	\$78.90	\$78.90	\$78.90	\$69.30	\$67.30	\$65.70
SOLID CARBIDE / SP PT TAP	3	3B	2	41340		\$81.40	\$81.40	\$81.40	\$81.40	\$81.40	\$71.00	\$68.90	\$67.30
COST CUTTER DRILL/TAP	3	3B	2	29013		\$15.60	\$15.60	\$15.60	\$15.60	\$15.60	\$15.60	\$15.60	\$15.60
TiN COAT/HAND TAP	5		4		50010	\$34.70	\$34.00	\$33.50	\$28.40	\$22.10	\$18.90	\$16.90	\$15.70
STI HAND TAP	2	3B	3	17842	17843	\$22.40	\$21.20	\$19.60	\$18.70	\$17.90	\$16.40	\$15.80	\$15.40
STI SPIRAL POINT TAP	2	3B	2	17844		\$23.90	\$22.60	\$21.10	\$20.10	\$19.40	\$17.80	\$17.30	\$16.90
STI HAND TAP	3	2B	3	17846	17847	\$22.40	\$21.20	\$19.60	\$18.70	\$17.90	\$16.40	\$15.80	\$15.40
STI SPIRAL POINT TAP	3	2B	2	17848		\$23.90	\$22.60	\$21.10	\$20.10	\$19.40	\$17.80	\$17.30	\$16.90
R.H. ROUND DIE 1"OD				13080		\$38.70	\$38.70	\$38.70	\$33.00	\$31.40	\$28.80	\$27.70	\$27.50
L.H. ROUND DIE 1"OD				13081		\$87.00	\$65.40	\$57.70	\$39.60	\$37.70	\$34.40	\$29.50	\$29.30
GAGE - Taperlock Style		2B		23108		\$92.40							
GAGE - Taperlock Style		3B		23109		\$92.40							
GAGE - Reversible Style		2B		24294		\$134.00							
GAGE - Reversible Style		3B		24295		\$134.00							
GAGE - Ring-Go		2A		23476		\$121.20							
GAGE - Ring-Go		3A		23477		\$121.20							
GAGE - Ring-NoGo		2A		23478		\$121.20							
GAGE - Ring-NoGo		3A		23479		\$121.20							
GAGE - STI Plug Taperlock Style		2B		24682		\$146.60							
GAGE - STI Plug Taperlock Style		3B		24683		\$146.60							
<b>1/4"-32 NEF</b>				<i>Recommended Hole Size based on 75% Thread = .2197"</i>									
HAND TAP	3	3B	4	15584	15585	\$11.00	\$11.00	\$11.00	\$11.00	\$8.80	\$8.80	\$8.80	\$8.80
L.H. HAND TAP	3	3B	4	17784	17785	\$51.80	\$48.40	\$47.20	\$40.30	\$28.40	\$22.30	\$18.10	\$17.00
SPIRAL POINT TAP	3	3B	2	15588		\$19.50	\$19.10	\$18.70	\$15.50	\$14.70	\$11.30	\$11.30	\$11.30
HAND TAP	5		4	15590	15591	\$17.10	\$16.90	\$16.50	\$13.80	\$13.30	\$10.00	\$9.60	\$9.10
R.H. ROUND DIE 1"OD				13082		\$87.00	\$65.40	\$57.70	\$39.60	\$37.70	\$34.40	\$29.50	\$29.30
GAGE - Taperlock Style		2B		23113		\$164.60							
GAGE - Taperlock Style		3B		23114		\$164.60							
GAGE - Reversible Style		2B		24937		\$231.50							
GAGE - Reversible Style		3B		24938		\$231.50							
GAGE - Ring-Go		2A		23482		\$175.50							
GAGE - Ring-Go		3A		23483		\$175.50							
GAGE - Ring-NoGo		2A		23484		\$175.50							
GAGE - Ring-NoGo		3A		23485		\$175.50							
<b>1/4"-36 NS</b>				<i>Recommended Hole Size based on 75% Thread = .2230"</i>									
HAND TAP	2	3B	4	15596	15597	\$24.30	\$24.00	\$23.40	\$20.10	\$15.30	\$12.70	\$12.10	\$10.80
SPIRAL POINT TAP	2	3B	2	15594		\$21.50	\$21.50	\$21.50	\$21.50	\$18.80	\$16.20	\$15.90	\$15.60
HAND TAP	3	2B	4	17759	17760	\$31.70	\$31.10	\$30.50	\$25.30	\$22.90	\$18.30	\$14.30	\$12.50
SPIRAL POINT TAP	3	2B	2	17572		\$26.40	\$24.60	\$22.30	\$20.60	\$18.70	\$16.20	\$15.90	\$15.60
TiN COAT / SP PT TAP	3	2B	2	50024		\$29.40	\$27.60	\$25.30	\$23.70	\$21.70	\$19.30	\$19.00	\$18.70
R.H. ROUND DIE 1"OD				13451		\$87.00	\$65.40	\$57.70	\$39.60	\$37.70	\$34.40	\$29.50	\$29.30
<b>1/4"-40 NS</b>				<i>Recommended Hole Size based on 75% Thread = .2258"</i>									
HAND TAP	2	3B	4	15602	15603	\$31.70	\$31.10	\$30.50	\$25.30	\$19.10	\$15.30	\$12.10	\$10.80
SPIRAL POINT TAP	2	3B	3	17573		\$26.40	\$24.60	\$22.30	\$20.60	\$18.70	\$16.20	\$15.90	\$15.60
HAND TAP	3	2B	4	15608	15609	\$31.70	\$31.10	\$30.50	\$25.30	\$19.10	\$15.30	\$12.10	\$10.80

TAPS, DIES & GAGES

Click on Item Number for Catalog Listing

SIZE/ DESCRIPTION	GH #	CLASS OF FIT	# FLUTES	ITEM #		1 PC	2 PC	3 PC	6 PC	9 PC	12 PC	24 PC	48 PC	
				PLUG	BOTTOM									
<b>1/4"-40 NS</b>						See Previous Page for Recommended Hole Size								
R.H. ROUND DIE 1"OD				13084		\$87.00	\$65.40	\$57.70	\$39.60	\$37.70	\$34.40	\$29.50	\$29.30	
<b>1/4"-48 NS</b>						Recommended Hole Size based on 75% Thread = .230"								
HAND TAP	2	3B	4	15614	15615	\$31.70	\$31.10	\$30.50	\$25.30	\$19.10	\$15.30	\$12.10	\$10.80	
R.H. ROUND DIE 1"OD				13086		\$87.00	\$65.40	\$57.70	\$39.60	\$37.70	\$34.40	\$29.50	\$29.30	
<b>1/4"-56 NS</b>						Recommended Hole Size based on 75% Thread = .2329"								
HAND TAP	2	3B	4	15620	15621	\$31.70	\$31.10	\$30.50	\$25.30	\$19.10	\$15.30	\$12.10	\$10.80	
R.H. ROUND DIE 1"OD				13088		\$87.00	\$65.40	\$57.70	\$39.60	\$37.70	\$34.40	\$29.50	\$29.30	
<b>1/4"-80 NS</b>						Recommended Hole Size based on 75% Thread = .2379"								
HAND TAP	2	3B	4	15638	15639	\$37.70	\$36.80	\$33.80	\$28.30	\$20.70	\$17.00	\$16.60	\$15.80	
R.H. ROUND DIE 1"OD				13090		\$87.00	\$65.40	\$57.70	\$39.60	\$37.70	\$34.40	\$29.50	\$29.30	
<b>9/32"-32 NS</b>						Recommended Hole Size based on 75% Thread = .2509"								
HAND TAP	3	2B	4	17589	17590	\$32.50	\$31.90	\$31.20	\$28.10	\$26.90	\$24.50	\$21.30	\$18.50	
<b>5/16"-18 NC</b>						Recommended Hole Size based on 75% Thread = .2589" for STI = .3320" / TRU-FLO at 65% Thread = .2879"								
L.H. HAND TAP	3	3B	4	15644	15645	\$10.90	\$10.90	\$10.90	\$10.90	\$10.90	\$10.90	\$10.90	\$10.90	
L.H. SPIRAL POINT TAP	3	3B	2	15642		\$21.40	\$21.40	\$21.40	\$21.40	\$21.40	\$21.40	\$17.30	\$15.40	
+.003 HAND TAP	7		4	15650	15651	\$32.50	\$31.80	\$31.20	\$26.10	\$23.20	\$18.30	\$14.60	\$11.80	
+.003 SPIRAL POINT TAP	7		2	15648		\$34.30	\$33.60	\$33.00	\$27.40	\$24.40	\$24.40	\$24.40	\$24.40	
+.005 HAND TAP	11	PLATING	4	15656	15657	\$12.70	\$12.70	\$12.70	\$12.70	\$12.70	\$12.70	\$12.70	\$12.70	
+.005 SPIRAL POINT TAP	11	PLATING	2	15654		\$14.30	\$14.30	\$14.30	\$14.30	\$14.30	\$14.30	\$14.30	\$14.30	
+.010 HAND TAP	21		4	15662	15663	\$39.40	\$38.60	\$35.50	\$29.60	\$26.30	\$24.00	\$19.40	\$17.90	
DOUBLE LEAD TAP	3	3B	4	15668	15669	\$30.90	\$30.90	\$30.90	\$30.90	\$30.90	\$27.50	\$24.60	\$24.10	
4" EXTENSION SPIRAL POINT TAP	3	3B	2	17585		\$39.70	\$37.90	\$33.80	\$32.50	\$31.80	\$31.30	\$28.10	\$25.90	
4" EXTENSION SP PT SM SHK TAP	3	3B	2	17966		\$43.10	\$41.30	\$37.30	\$35.90	\$35.20	\$34.20	\$33.60	\$32.30	
6" EXTENSION HAND TAP	3	3B	4	15673	15674	\$25.20	\$25.20	\$25.20	\$25.20	\$25.20	\$25.20	\$25.20	\$25.20	
6" EXTENSION SM SHK HAND TAP	3	3B	4	17608	17609	\$40.00	\$38.70	\$37.00	\$35.40	\$31.80	\$30.10	\$27.50	\$24.90	
6" EXTENSION SPIRAL POINT TAP	3	3B	2	15671		\$26.40	\$26.40	\$26.40	\$26.40	\$26.40	\$26.40	\$26.40	\$26.40	
6" EXTENSION SP PT SM SHK TAP	3	3B	2	17610		\$41.30	\$40.10	\$38.40	\$36.70	\$33.20	\$31.50	\$28.90	\$26.30	
8" EXTENSION HAND TAP	3	3B	4	15678	15679	\$29.80	\$29.20	\$28.70	\$27.70	\$27.70	\$27.70	\$27.70	\$27.00	
TRU-FLO FORM TAP	5	3B		19082	19083	\$42.00	\$38.00	\$35.80	\$31.50	\$28.00	\$26.30	\$23.70	\$21.10	
TRU-FLO FORM TAP	7	2B		19084	19085	\$42.00	\$38.00	\$35.80	\$31.50	\$28.00	\$26.30	\$23.70	\$21.10	
TRU-FLO FORM TAP	10	PLATING		19086	19087	\$42.00	\$38.00	\$35.80	\$31.50	\$28.00	\$26.30	\$23.70	\$21.10	
SOLID CARBIDE / HAND TAP	3	3B	4	41378	41379	\$91.00	\$91.00	\$91.00	\$91.00	\$91.00	\$79.20	\$77.40	\$75.60	
SOLID CARBIDE / SP PT TAP	3	3B	2	41373		\$93.40	\$93.40	\$93.40	\$93.40	\$93.40	\$80.70	\$79.10	\$77.20	
COST CUTTER DRILL/TAP	3	3B	2	29014		\$23.10	\$23.10	\$23.10	\$23.10	\$23.10	\$23.10	\$23.10	\$23.10	
TiN COAT / SP PT x 6" TAP	3	3B	2	50011		\$33.80	\$33.70	\$33.70	\$33.70	\$33.70	\$33.70	\$33.70	\$33.70	
STI HAND TAP	3	3B	4	17850	17851	\$24.30	\$23.00	\$21.50	\$20.50	\$19.80	\$18.10	\$17.90	\$17.30	
STI SPIRAL POINT TAP	3	3B	3	17852		\$25.80	\$24.50	\$22.90	\$22.00	\$21.30	\$19.60	\$19.40	\$18.80	
STI HAND TAP	4	2B	4	17854	17855	\$24.30	\$23.00	\$21.50	\$20.50	\$19.80	\$18.10	\$17.90	\$17.30	
STI SPIRAL POINT TAP	4	2B	3	17856		\$25.80	\$24.50	\$22.90	\$22.00	\$21.30	\$19.60	\$19.40	\$18.80	
R.H. ROUND DIE 1"OD				13100		\$38.70	\$38.70	\$38.70	\$33.00	\$31.40	\$28.80	\$27.70	\$27.50	
L.H. ROUND DIE 1"OD				13101		\$82.20	\$61.50	\$54.60	\$37.10	\$35.50	\$32.50	\$28.00	\$27.60	
GAGE - Taperlock Style		2B		23118		\$92.40								
GAGE - Taperlock Style		3B		23119		\$92.40								



Click on Item Number for Catalog Listing

SIZE/ DESCRIPTION	GH #	CLASS OF FIT	# FLUTES	ITEM #		1 PC	2 PC	3 PC	6 PC	9 PC	12 PC	24 PC	48 PC
				PLUG	BOTTOM								
<b>5/16"-18 NC</b>				<i>See Previous Page for Recommended Hole Size</i>									
GAGE - Reversible Style		2B		24299		\$134.00							
GAGE - Reversible Style		3B		24300		\$134.00							
GAGE - Ring-Go		2A		23488		\$121.20							
GAGE - Ring-Go		3A		23489		\$121.20							
GAGE - Ring-NoGo		2A		23490		\$121.20							
GAGE - Ring-NoGo		3A		23491		\$121.20							
GAGE - STI Plug Taperlock Style		2B		24687		\$146.60							
GAGE - STI Plug Taperlock Style		3B		24688		\$146.60							
<b>5/16"-18 BSW 55° MOD WHITWORTH</b>				<i>Recommended Hole Size = .2591"</i>									
	3		4	17625	17626	\$75.50	\$75.50	\$75.50	\$63.20	\$50.90	\$37.60	\$30.30	\$27.40
<b>5/16"-20 NS</b>				<i>Recommended Hole Size based in 75% Thread = .264"</i>									
HAND TAP	3	3B	4	15684	15685	\$25.30	\$25.00	\$24.30	\$20.30	\$17.30	\$14.80	\$13.30	\$11.90
R.H. ROUND DIE 1"OD				13102		\$87.00	\$65.40	\$57.70	\$39.60	\$37.70	\$34.40	\$29.50	\$29.30
GAGE - Taperlock Style		2B		22169		\$195.50							
GAGE - Taperlock Style		3B		22170		\$195.50							
GAGE - Ring-Go		2A		22171		\$249.70							
GAGE - Ring-Go		3A		22172		\$249.70							
GAGE - Ring-NoGo		2A		22173		\$249.70							
GAGE - Ring-NoGo		3A		22174		\$249.70							
<b>5/16"-22 BSF 55° MOD WHITWORTH</b>				<i>Recommended Hole Size = .2688"</i>									
	3		4	15690	15691	\$66.40	\$66.40	\$66.40	\$55.10	\$43.80	\$32.70	\$25.90	\$23.40
<b>5/16"-24 NF</b>				<i>Recommended Hole Size based in 75% Thread = .2715" for STI = .3281" / TRU-FLO at 65% Thread = .2941"</i>									
L.H. HAND TAP	3	3B	4	15696	15697	\$10.90	\$10.90	\$10.90	\$10.90	\$10.90	\$10.50	\$10.50	\$10.50
L.H. SPIRAL POINT TAP	3	3B	2	15694		\$20.60	\$20.60	\$20.60	\$20.60	\$20.60	\$20.60	\$17.30	\$15.40
4" EXTENSION SP PT SM SHK TAP	3	3B	2	17967		\$43.10	\$41.30	\$37.30	\$35.90	\$35.20	\$34.20	\$33.60	\$32.30
HAND TAP	5		4	17650	17651	\$37.00	\$35.70	\$34.40	\$33.10	\$30.00	\$24.10	\$19.50	\$17.90
SPIRAL POINT TAP	5		2	17737		\$38.40	\$34.30	\$31.90	\$28.60	\$25.00	\$23.40	\$20.70	\$18.10
HAND TAP	6		4	17707	17708	\$37.00	\$35.70	\$34.40	\$33.10	\$30.00	\$24.10	\$19.50	\$17.90
+.005 HAND TAP	11	PLATING	4	15708	15709	\$12.70	\$12.70	\$12.70	\$12.70	\$12.70	\$11.80	\$11.80	\$11.80
+.005 SPIRAL POINT TAP	11	PLATING	2	15706		\$13.30	\$13.30	\$13.30	\$13.30	\$13.30	\$12.20	\$12.20	\$12.20
6" EXTENSION HAND TAP	3	3B	4	15713	15714	\$25.50	\$25.50	\$25.50	\$25.50	\$25.50	\$25.50	\$25.50	\$25.50
6" EXTENSION SPIRAL POINT TAP	3	3B	2	15711		\$26.40	\$26.40	\$26.40	\$26.40	\$26.40	\$26.40	\$26.40	\$26.40
6" EXTENSION SP PT SM SHK TAP	3	3B	2	17611		\$41.30	\$40.10	\$38.40	\$36.70	\$33.20	\$31.50	\$28.90	\$26.30
TRU-FLO FORM TAP	5	3B		19088	19089	\$42.00	\$38.00	\$35.80	\$31.50	\$28.00	\$26.30	\$23.70	\$21.10
TRU-FLO FORM TAP	7	2B		19090	19091	\$42.00	\$38.00	\$35.80	\$31.50	\$28.00	\$26.30	\$23.70	\$21.10
TRU-FLO FORM TAP	10	PLATING		19092	19093	\$42.00	\$38.00	\$35.80	\$31.50	\$28.00	\$26.30	\$23.70	\$21.10
SOLID CARBIDE / HAND TAP	3	3B	4	41411	41412	\$91.00	\$91.00	\$91.00	\$91.00	\$91.00	\$79.20	\$77.40	\$75.60
SOLID CARBIDE SP PT TAP	3	3B	2	41406		\$93.40	\$93.40	\$93.40	\$93.40	\$93.40	\$80.70	\$79.10	\$77.20
COST CUTTER DRILL/TAP	3	3B	2	29015		\$23.10	\$23.10	\$23.10	\$23.10	\$23.10	\$23.10	\$23.10	\$23.10
STI HAND TAP	2	3B	4	17858	17859	\$24.30	\$23.00	\$21.50	\$20.50	\$19.80	\$18.10	\$17.90	\$17.30
STI SPIRAL POINT TAP	2	3B	3	17860		\$25.80	\$24.50	\$22.90	\$22.00	\$21.30	\$19.60	\$19.40	\$18.80
STI HAND TAP	3	2B	4	17862	17863	\$24.30	\$23.00	\$21.50	\$20.50	\$19.80	\$18.10	\$17.90	\$17.30



TAPS, DIES & GAGES

Click on Item Number for Catalog Listing

SIZE/ DESCRIPTION	GH #	CLASS OF FIT	# FLUTES	ITEM #		1 PC	2 PC	3 PC	6 PC	9 PC	12 PC	24 PC	48 PC
				PLUG	BOTTOM								
<b>5/16"-24 NF</b>						<i>See Previous Page for Recommended Hole Size</i>							
STI SPIRAL POINT TAP	3	2B	3	17864		\$25.80	\$24.50	\$22.90	\$22.00	\$21.30	\$19.60	\$19.40	\$18.80
R.H. ROUND DIE 1"OD				13104		\$38.70	\$38.70	\$38.70	\$33.00	\$31.40	\$28.80	\$27.70	\$27.50
L.H. ROUND DIE 1"OD				13105		\$87.00	\$65.40	\$57.70	\$39.60	\$37.70	\$34.40	\$29.50	\$29.30
GAGE - Taperlock Style		2B		23123		\$92.40							
GAGE - Taperlock Style		3B		23124		\$92.40							
GAGE - Reversible Style		2B		24304		\$134.00							
GAGE - Reversible Style		3B		24305		\$134.00							
GAGE - Ring-Go		2A		23494		\$121.20							
GAGE - Ring-Go		3A		23495		\$121.20							
GAGE - Ring-NoGo		2A		23496		\$121.20							
GAGE - Ring-NoGo		3A		23497		\$121.20							
GAGE - STI Plug Taperlock Style		2B		24692		\$146.60							
GAGE - STI Plug Taperlock Style		3B		24693		\$146.60							
<b>5/16"-27 NS</b>						<i>Recommended Hole Size based on 75% Thread = .2765"</i>							
HAND TAP	3	3B	4	15719	15720	\$25.30	\$25.00	\$24.30	\$20.30	\$17.30	\$14.80	\$13.30	\$11.90
R.H. ROUND DIE 1"OD				13106		\$87.00	\$65.40	\$57.70	\$39.60	\$37.70	\$34.40	\$29.50	\$29.30
<b>5/16"-28 NS</b>						<i>Recommended Hole Size based on 75% Thread = .2778"</i>							
HAND TAP	3	3B	4	15725	15726	\$25.30	\$25.00	\$24.30	\$20.30	\$17.30	\$14.80	\$13.30	\$11.90
GAGE - Taperlock Style		2B		22183		\$210.30							
GAGE - Taperlock Style		3B		22184		\$210.30							
GAGE - Ring-Go		2A		22185		\$256.50							
GAGE - Ring-Go		3A		22186		\$256.50							
GAGE - Ring-NoGo		2A		22187		\$256.50							
GAGE - Ring-NoGo		3A		22188		\$256.50							
<b>5/16"-32 NEF</b>						<i>Recommended Hole Size based on 75% Thread = .2822"</i>							
HAND TAP	3	3B	4	15730	15731	\$11.80	\$11.80	\$11.80	\$11.80	\$11.80	\$11.80	\$11.80	\$11.80
SPIRAL POINT TAP	3	3B	2	15728		\$21.90	\$21.60	\$20.90	\$17.50	\$14.90	\$12.70	\$12.30	\$12.00
HAND TAP	5		4	15735	15736	\$31.50	\$26.40	\$18.30	\$14.40	\$11.80	\$11.80	\$11.80	\$11.80
R.H. ROUND DIE 1"OD				13108		\$87.00	\$65.40	\$57.70	\$39.60	\$37.70	\$34.40	\$29.50	\$29.30
GAGE - Taperlock Style		2B		23128		\$164.60							
GAGE - Taperlock Style		3B		23129		\$164.60							
GAGE - Reversible Style		2B		24942		\$231.50							
GAGE - Reversible Style		3B		24943		\$231.50							
GAGE - Ring-Go		2A		23500		\$175.50							
GAGE - Ring-Go		3A		23501		\$175.50							
GAGE - Ring-NoGo		2A		23502		\$175.50							
GAGE - Ring-NoGo		3A		23503		\$175.50							
<b>5/16"-40 NS</b>						<i>Recommended Hole Size based on 75% Thread = .2883"</i>							
HAND TAP	2	3B	4	15740	15741	\$36.00	\$31.00	\$25.30	\$22.00	\$17.30	\$14.80	\$13.30	\$11.90
R.H. ROUND DIE 1"OD				13110		\$87.00	\$65.40	\$57.70	\$39.60	\$37.70	\$34.40	\$29.50	\$29.30
<b>11/32"-32 NS</b>						<i>Recommended Hole Size based on 75% Thread = .3134"</i>							
HAND TAP	3	3B	4	15750	15751	\$36.30	\$35.80	\$34.80	\$29.00	\$24.30	\$22.00	\$18.00	\$16.00
<b>3/8"-12 ACME</b>						<i>Recommended Hole Size = .2917"</i>							
TANDEM TAP		2G	4	15752		\$149.40	\$119.50	\$83.80	\$68.70	\$58.40	\$57.50	\$54.90	\$52.30





Click on Item Number  
for Catalog Listing

SIZE/ DESCRIPTION	GH #	CLASS OF FIT	# FLUTES	ITEM #		1 PC	2 PC	3 PC	6 PC	9 PC	12 PC	24 PC	48 PC
				PLUG	BOTTOM								
<b>3/8"-16 NC</b>				<i>Recommended Hole Size based on 75% Thread = .3144" for STI = .3970" / TRU-FLO at 65% Thread = .3474"</i>									
FAST SPIRAL FLUTE TAP	5	2B	3	17912	17913	\$99.70	\$68.50	\$58.00	\$36.20	\$30.60	\$28.90	\$26.30	\$23.50
L.H. HAND TAP	3	3B	4	15756	15757	\$14.30	\$14.30	\$14.30	\$14.30	\$14.30	\$13.20	\$13.20	\$13.20
L.H. SPIRAL POINT TAP	3	3B	3	15754		\$21.30	\$21.30	\$21.30	\$21.30	\$21.30	\$21.30	\$18.00	\$16.00
SPIRAL POINT TAP	3	3B	2	17738		\$26.80	\$24.60	\$22.40	\$21.30	\$20.20	\$19.20	\$18.00	\$16.00
+.003 HAND TAP	7		4	15766	15767	\$36.10	\$35.50	\$34.60	\$28.90	\$26.60	\$21.20	\$17.20	\$15.30
+.003 SPIRAL POINT TAP	7		3	15764		\$42.30	\$42.30	\$42.30	\$37.70	\$28.30	\$22.70	\$18.30	\$16.90
+.005 HAND TAP	11	PLATING	4	15771	15772	\$14.60	\$14.60	\$14.60	\$14.60	\$14.60	\$13.30	\$13.30	\$13.30
+.005 SPIRAL POINT TAP	11	PLATING	3	15769		\$15.10	\$15.10	\$15.10	\$15.10	\$15.10	\$13.80	\$13.80	\$13.80
+.010 HAND TAP	21		4	15776	15777	\$34.80	\$34.30	\$33.50	\$28.20	\$23.50	\$21.20	\$17.20	\$15.30
SMALL SHANK TAP	3	3B	4	15761	15762	\$35.10	\$34.50	\$33.60	\$28.10	\$24.50	\$23.00	\$23.00	\$23.00
DOUBLE LEAD TAP	3	3B	4	15781	15782	\$48.30	\$47.60	\$35.20	\$38.60	\$29.00	\$27.20	\$23.20	\$21.60
4" EXTENSION SP PT SM SHK TAP	3	3B	3	17969		\$46.20	\$44.50	\$40.40	\$39.00	\$38.30	\$37.40	\$36.70	\$35.50
4" EXTENSION SPIRAL POINT TAP	3	3B	3	17586		\$39.70	\$37.90	\$33.80	\$32.50	\$31.80	\$31.30	\$28.10	\$25.90
6" EXTENSION HAND TAP	3	3B	4	15786	15787	\$27.00	\$27.00	\$27.00	\$27.00	\$27.00	\$27.00	\$27.00	\$27.00
6" EXTENSION SM SHANK TAP	3	3B	4	15801	15802	\$42.10	\$42.10	\$42.10	\$42.10	\$42.10	\$42.10	\$42.10	\$40.00
6" EXTENSION SPIRAL POINT TAP	3	3B	3	15784		\$28.70	\$28.70	\$28.70	\$28.70	\$28.70	\$28.70	\$28.70	\$28.70
6" EXTENSION SP PT SM SHK TAP	3	3B	3	15799		\$42.60	\$42.60	\$42.60	\$42.60	\$42.60	\$42.60	\$42.60	\$40.60
6" EXTENSION HAND TAP	5	2B	4	17658	17659	\$82.50	\$61.30	\$50.80	\$40.40	\$36.80	\$35.20	\$32.50	\$29.90
6" EXTENSION SPIRAL POINT TAP	5	2B	3	17666		\$100.20	\$71.50	\$53.60	\$45.80	\$40.90	\$38.70	\$35.50	\$33.80
8" EXTENSION HAND TAP	3	3B	4	15791	15792	\$35.10	\$35.10	\$35.10	\$35.10	\$35.10	\$35.10	\$35.10	\$35.10
10" EXTENSION HAND TAP	3	3B	4	15796	15797	\$82.10	\$75.70	\$65.30	\$54.80	\$51.30	\$49.60	\$47.00	\$44.40
TRU-FLO FORM TAP	5	3B		19094	19095	\$43.80	\$39.90	\$37.70	\$33.40	\$29.80	\$28.20	\$25.50	\$22.90
TRU-FLO FORM TAP	7	2B		19096	19097	\$43.80	\$39.90	\$37.70	\$33.40	\$29.80	\$28.20	\$25.50	\$22.90
TRU-FLO FORM TAP	10	PLATING		19098	19099	\$43.80	\$39.90	\$37.70	\$33.40	\$29.80	\$28.20	\$25.50	\$22.90
SOLID CARBIDE / HAND TAP	3	3B	4	41444	41445	\$113.50	\$102.30	\$96.70	\$91.00	\$88.70	\$85.30	\$82.00	\$79.60
SOLID CARBIDE / SP PT TAP	3	3B	3	41442		\$117.10	\$105.70	\$100.20	\$92.60	\$90.30	\$87.00	\$83.50	\$81.20
COST CUTTER DRILL/TAP	3	3B	2	29016		\$27.80	\$27.80	\$27.80	\$27.80	\$27.80	\$27.80	\$27.80	\$27.80
TIN COAT/SP PT x 6" TAP	3	3B	3	50012		\$36.00	\$36.00	\$36.00	\$36.00	\$36.00	\$36.00	\$36.00	\$36.00
TIN COAT/SP PT x 6"/SM SHK TAP	3	3B	3	50013		\$49.90	\$49.90	\$49.90	\$49.90	\$49.90	\$49.90	\$49.90	\$47.90
STI HAND TAP	3	3B	4	17866	17867	\$29.50	\$28.30	\$26.70	\$25.80	\$25.00	\$23.20	\$23.10	\$22.80
STI SPIRAL POINT TAP	3	3B	3	17868		\$31.70	\$30.50	\$28.90	\$28.00	\$27.20	\$25.40	\$25.30	\$25.00
STI HAND TAP	4	2B	4	17870	17871	\$29.50	\$28.30	\$26.70	\$25.80	\$25.00	\$23.20	\$23.10	\$22.80
STI SPIRAL POINT TAP	4	2B	3	17872		\$31.70	\$30.50	\$28.90	\$28.00	\$27.20	\$25.40	\$25.30	\$25.00
R.H. ROUND DIE 1"OD				13116		\$38.70	\$38.70	\$38.70	\$33.00	\$31.40	\$28.80	\$27.70	\$27.50
L.H. ROUND DIE 1"OD				13117		\$87.00	\$65.40	\$57.70	\$39.60	\$37.70	\$34.40	\$29.50	\$29.30
GAGE - Taperlock Style		2B		23133		\$99.60							
GAGE - Taperlock Style		3B		23134		\$99.60							
GAGE - Reversible Style		2B		24309		\$144.90							
GAGE - Reversible Style		3B		24310		\$144.90							
GAGE - Ring-Go		2A		23506		\$132.10							
GAGE - Ring-Go		3A		23507		\$132.10							
GAGE - Ring-NoGo		2A		23508		\$132.10							
GAGE - Ring-NoGo		3A		23509		\$132.10							

TAPS, DIES & GAGES

Click on Item Number for Catalog Listing

SIZE/ DESCRIPTION	GH #	CLASS OF FIT	# FLUTES	ITEM #		1 PC	2 PC	3 PC	6 PC	9 PC	12 PC	24 PC	48 PC
				PLUG	BOTTOM								
<b>3/8"-16 NC</b>						<i>See Previous Page for Recommended Hole Size</i>							
GAGE - STI Plug Taperlock Style		2B		24697		\$146.60							
GAGE - STI Plug Taperlock Style		3B		24698		\$146.60							
<b>3/8"-18 NS</b>						<i>Recommended Hole Size based on 75% Thread = .3214"</i>							
<b>HAND TAP</b>	<b>3</b>	<b>3B</b>	<b>4</b>	<b>15806</b>	<b>15807</b>	<b>\$28.70</b>	<b>\$28.30</b>	<b>\$27.60</b>	<b>\$24.60</b>	<b>\$19.20</b>	<b>\$16.50</b>	<b>\$15.40</b>	<b>\$13.50</b>
R.H. ROUND DIE 1"OD				13118		\$87.00	\$65.40	\$57.70	\$39.60	\$37.70	\$34.40	\$29.50	\$29.30
<b>3/8"-18 PIPE TAP</b>						<i>Recommended Hole Size: NPT = .5625" / NPTF = .5781" NPSF/NPSI = .5781"</i>							
<b>NPT/F REGULAR SP FLT TAPER TAP</b>			4	15809		\$66.00	\$62.70	\$52.30	\$41.80	\$38.30	\$36.60	\$34.00	\$31.40
<b>NPT/F LEFT HAND TAPER TAP</b>			4	15812		\$67.50	\$66.40	\$62.20	\$54.00	\$40.50	\$33.70	\$32.40	\$28.40
<b>NPT/F 6" EXTENSION TAPER TAP</b>			4	15815		\$65.50	\$64.80	\$64.20	\$63.50	\$47.60	\$39.20	\$38.70	\$38.00
<b>NPT/F 6 INT EXT TAPER TAP</b>			5	15818		\$46.20	\$46.20	\$46.20	\$46.20	\$46.20	\$40.20	\$39.30	\$38.40
<b>NPT/F 8" EXTENSION TAPER TAP</b>			4	15821		\$81.80	\$80.40	\$78.60	\$68.20	\$64.60	\$63.10	\$58.50	\$57.70
<b>NPSI STRAIGHT TAP</b>			4	15827		\$67.50	\$66.40	\$64.70	\$51.90	\$40.50	\$33.70	\$32.30	\$28.40
<b>NPSF 6" EXTENSION TAP</b>			4	17922		\$115.30	\$84.00	\$73.50	\$63.10	\$59.50	\$57.80	\$55.20	\$52.60
<b>NPT/F CARB-I-SERT TAP</b>			4	41808		\$434.40	\$394.30	\$357.60	\$332.50	\$310.30	\$299.40	\$287.40	\$278.10
<b>NPT/F COST CUTTER DRILL/ TAP</b>			4	29043		\$112.50	\$109.50	\$107.30	\$105.50	\$102.40	\$100.30	\$96.60	\$92.40
<b>NPT/F TiN COAT x 6 TAP</b>			4	50014		\$81.00	\$80.40	\$79.80	\$79.10	\$63.20	\$54.80	\$54.30	\$53.60
<b>NPT/F TiN COAT/INT.TH D x 6" TAP</b>			5	50015		\$61.80	\$61.80	\$61.80	\$61.80	\$61.80	\$55.70	\$54.90	\$54.00
<b>NPT R.H. ROUND DIE 1-1/2"OD</b>				13136		\$106.10	\$81.90	\$76.00	\$64.90	\$62.10	\$56.90	\$51.40	\$51.20
<b>NPS R.H. ROUND DIE 1-1/2"OD</b>				13138		\$158.30	\$131.60	\$86.80	\$76.30				
<b>GAGE L1 NPT PLG w/handle</b>				24377		\$98.00							
<b>GAGE L1 NPT RING</b>				24375		\$177.20							
<b>GAGE L1 NPTF PLG w/handle</b>				24442		\$149.60							
<b>GAGE L3 NPTF PLG w/handle</b>				24444		\$149.60							
<b>GAGE NPTF 6 step Plain Plug w/handle</b>				24536		\$210.30							
<b>GAGE L1 NPTF RING</b>				24498		\$182.70							
<b>GAGE L2 NPTF RING</b>				24500		\$311.80							
<b>GAGE NPTF 6 step Plain Ring</b>				24570		\$341.20							
<b>3/8"-19 55° WHITWORTH PIPE</b>						<i>Recommended Hole Size: BSPT = .5781" / BSPP = 5938"</i>							
<b>BSPT TAPER - MODIFIED TAP</b>			4	15830	15831	\$28.40	\$28.40	\$28.40	\$28.40	\$28.40	\$28.40	\$28.40	\$28.40
<b>BSPP PARALLEL - MODIFIED TAP</b>			4	15833	15834	\$28.40	\$28.40	\$28.40	\$28.40	\$28.40	\$28.40	\$28.40	\$28.40
<b>BSPT TAPER - FULL FORM TAP</b>			4	17934		\$79.40	\$74.20	\$71.20	\$68.60	\$67.20	\$64.90	\$62.30	\$59.70
<b>BSPP PARALLEL - FULL FORM TAP</b>			4	17925		\$79.40	\$74.20	\$71.20	\$68.60	\$67.20	\$64.90	\$62.30	\$59.70
<b>BSPT R.H. ROUND DIE 1-1/2"OD</b>				13696		\$341.20							
<b>BSPP R.H. ROUND DIE 1-1/2"OD</b>				13697		\$120.60							
<b>GAGE BSPP-Mod. DBL END w/handle</b>				27047		\$363.80							
<b>GAGE BSPT-Mod. w/handle</b>				27008		\$292.10							



Click on Item Number  
for Catalog Listing

SIZE/ DESCRIPTION	GH #	CLASS OF FIT	# FLUTES	ITEM #		1 PC	2 PC	3 PC	6 PC	9 PC	12 PC	24 PC	48 PC
				PLUG	BOTTOM								
<b>3/8"-20 NS</b>						<i>Recommended Hole Size based on 75% Thread = .3265"</i>							
HAND TAP	3	3B		15838	15839	\$28.10	\$27.50	\$26.90	\$22.40	\$18.40	\$16.50	\$15.40	\$13.50
R.H. ROUND DIE 1"OD				13120		\$87.00	\$65.40	\$57.70	\$39.60	\$37.70	\$34.40	\$29.50	\$29.30
GAGE - Taperlock Style		2B		22197		\$195.50							
GAGE - Taperlock Style		3B		22198		\$195.50							
GAGE - Ring-Go		2A		22199		\$256.50							
GAGE - Ring-Go		3A		22200		\$256.50							
GAGE - Ring-NoGo		2A		22201		\$256.50							
GAGE - Ring-NoGo		3A		22202		\$256.50							
<b>3/8"-20 BSF 55° MOD WHITWORTH</b>						<i>Recommended Hole Size = .327"</i>							
	3		4	17630	17631	\$77.60	\$77.60	\$77.60	\$65.30	\$53.00	\$39.70	\$32.30	\$29.50
<b>3/8"-24 NF</b>						<i>Recommended Hole Size based on 75% Thread = .3340" for STI = .3906" / TRU-FLO at 65% Thread = .3566"</i>							
REGULAR SPIRAL FLT TAP	5		3	17724	17725	\$80.00	\$48.60	\$38.20	\$27.70	\$24.20	\$22.50	\$19.90	\$17.30
L.H. HAND TAP	3	3B	4	15843	15844	\$14.60	\$14.60	\$14.60	\$14.60	\$14.60	\$13.30	\$13.30	\$13.30
L.H. SPIRAL POINT TAP	3	3B	3	15841		\$21.20	\$21.20	\$21.20	\$18.70	\$18.70	\$18.70	\$18.00	\$16.00
HAND TAP	5		4	15848	15849	\$37.40	\$36.50	\$35.90	\$29.80	\$26.60	\$21.20	\$17.20	\$15.30
HAND TAP	8		4	17915	17916	\$37.40	\$36.50	\$35.90	\$29.80	\$26.60	\$21.20	\$17.20	\$15.30
SPIRAL POINT TAP	5		3	15846		\$43.00	\$40.80	\$40.00	\$33.20	\$28.00	\$22.70	\$18.30	\$16.90
+.003 HAND TAP	7		4	15853	15854	\$37.40	\$36.50	\$35.90	\$29.80	\$26.60	\$21.20	\$17.20	\$15.30
+.003 SPIRAL POINT TAP	7		3	15851		\$43.00	\$40.80	\$40.00	\$33.20	\$28.00	\$22.70	\$18.30	\$16.90
+.005 HAND TAP	11	PLATING	4	15858	15859	\$26.70	\$26.30	\$25.70	\$21.50	\$17.80	\$17.10	\$17.10	\$17.10
+.005 SPIRAL POINT TAP	11	PLATING	3	15856		\$28.80	\$28.30	\$27.10	\$22.90	\$18.30	\$18.30	\$18.30	\$18.30
4" EXTENSION SP PT SM SHK TAP	3	3B	3	17970		\$46.20	\$44.50	\$40.40	\$39.00	\$38.30	\$37.40	\$36.70	\$35.50
6" EXTENSION HAND TAP	3	3B	4	15863	15864	\$32.40	\$31.40	\$30.40	\$29.30	\$28.40	\$28.40	\$28.40	\$28.40
6" EXTENSION SPIRAL POINT TAP	3	3B	3	15861		\$37.70	\$36.60	\$35.80	\$31.90	\$31.00	\$31.00	\$31.00	\$31.00
TRU-FLO FORM TAP	5	3B		19100	19101	\$43.80	\$39.90	\$37.70	\$33.40	\$29.80	\$28.20	\$25.50	\$22.90
TRU-FLO FORM TAP	7	2B		19102	19103	\$43.80	\$39.90	\$37.70	\$33.40	\$29.80	\$28.20	\$25.50	\$22.90
TRU-FLO FORM TAP	10	PLATING		19104	19105	\$43.80	\$39.90	\$37.70	\$33.40	\$29.80	\$28.20	\$25.50	\$22.90
SOLID CARBIDE / HAND TAP	3	3B	4	41476	41477	\$113.50	\$102.30	\$96.70	\$91.00	\$88.70	\$85.30	\$82.00	\$79.60
COST CUTTER DRILL/TAP	3	3B	2	29017		\$27.80	\$27.80	\$27.80	\$27.80	\$27.80	\$27.80	\$27.80	\$27.80
TIN COAT / +.003 HAND TAP	7		4		50016	\$42.00	\$41.10	\$40.50	\$34.40	\$31.20	\$25.80	\$21.80	\$19.90
STI HAND TAP	2	3B	4	17874	17875	\$29.50	\$28.30	\$26.70	\$25.80	\$25.00	\$23.20	\$23.10	\$22.80
STI SPIRAL POINT TAP	2	3B	3	17876		\$31.70	\$30.50	\$28.90	\$28.00	\$27.20	\$25.40	\$25.30	\$25.00
STI HAND TAP	3	2B	4	17878	17879	\$29.50	\$28.30	\$26.70	\$25.80	\$25.00	\$23.20	\$23.10	\$22.80
STI SPIRAL POINT TAP	3	2B	3	17880		\$31.70	\$30.50	\$28.90	\$28.00	\$27.20	\$25.40	\$25.30	\$25.00
R.H. ROUND DIE 1"OD				13122		\$38.70	\$38.70	\$38.70	\$33.00	\$31.40	\$28.80	\$27.70	\$27.50
L.H. ROUND DIE 1"OD				13123		\$87.00	\$65.40	\$57.70	\$39.60	\$37.70	\$34.40	\$29.50	\$29.30
GAGE - Taperlock Style		2B		23138		\$99.60							
GAGE - Taperlock Style		3B		23139		\$99.60							
GAGE - Reversible Style		2B		24314		\$144.90							
GAGE - Reversible Style		3B		24315		\$144.90							
GAGE - Ring-Go		2A		23512		\$132.10							
GAGE - Ring-Go		3A		23513		\$132.10							
GAGE - Ring-NoGo		2A		23514		\$132.10							
GAGE - Ring-NoGo		3A		23515		\$132.10							

TAPS, DIES & GAGES

Click on Item Number for Catalog Listing

SIZE/ DESCRIPTION	GH #	CLASS OF FIT	# FLUTES	ITEM #		1 PC	2 PC	3 PC	6 PC	9 PC	12 PC	24 PC	48 PC
				PLUG	BOTTOM								
<b>3/8"-24 NF</b>						<i>See Previous Page for Recommended Hole Size</i>							
GAGE - STI Plug Taperlock Style		2B		24702		\$146.60							
GAGE - STI Plug Taperlock Style		3B		24703		\$146.60							
<b>3/8"-27 NS</b>						<i>Recommended Hole Size based on 75% Thread = .339"</i>							
<b>HAND TAP</b>	<b>3</b>	<b>3B</b>	<b>4</b>	<b>15868</b>	<b>15869</b>	\$28.40	\$28.00	\$27.20	\$24.60	\$19.20	\$16.50	\$15.40	\$13.50
R.H. ROUND DIE 1"OD				13124		\$87.00	\$65.40	\$57.70	\$39.60	\$37.70	\$34.40	\$29.50	\$29.30
<b>3/8"-28 NS</b>						<i>Recommended Hole Size based on 75% Thread = .3403"</i>							
<b>HAND TAP</b>	<b>3</b>	<b>3B</b>	<b>4</b>	<b>15873</b>	<b>15874</b>	\$28.40	\$28.00	\$27.20	\$24.60	\$19.20	\$16.50	\$15.40	\$13.50
GAGE - Taperlock Style		2B		22211		\$210.30							
GAGE - Taperlock Style		3B		22212		\$210.30							
GAGE - Ring-Go		2A		22213		\$264.60							
GAGE - Ring-Go		3A		22214		\$264.60							
GAGE - Ring-NoGo		2A		22215		\$264.60							
GAGE - Ring-NoGo		3A		22216		\$264.60							
<b>3/8"-32 NEF</b>						<i>Recommended Hole Size based on 75% Thread = .3447"</i>							
<b>HAND TAP</b>	<b>3</b>	<b>3B</b>	<b>4</b>	<b>15878</b>	<b>15879</b>	\$13.20	\$13.20	\$13.20	\$13.20	\$11.00	\$11.00	\$11.00	\$11.00
<b>SPIRAL POINT TAP</b>	<b>3</b>	<b>3B</b>	<b>3</b>	<b>15876</b>		\$24.70	\$24.40	\$23.70	\$19.80	\$16.40	\$14.90	\$14.30	\$13.30
<b>HAND TAP</b>	<b>5</b>		<b>4</b>	<b>15883</b>	<b>15884</b>	\$22.30	\$22.00	\$21.50	\$17.80	\$15.10	\$14.20	\$13.00	\$12.20
R.H. ROUND DIE 1"OD				13128		\$87.00	\$65.40	\$57.70	\$39.60	\$37.70	\$34.40	\$29.50	\$29.30
GAGE - Taperlock Style		2B		23143		\$189.90							
GAGE - Taperlock Style		3B		23144		\$189.90							
GAGE - Reversible Style		2B		24947		\$253.30							
GAGE - Reversible Style		3B		24948		\$253.30							
GAGE - Ring-Go		2A		23518		\$179.20							
GAGE - Ring-Go		3A		23519		\$179.20							
GAGE - Ring-NoGo		2A		23520		\$179.20							
GAGE - Ring-NoGo		3A		23521		\$179.20							
<b>3/8"-40 NS</b>						<i>Recommended Hole Size based on 75% Thread = .3508"</i>							
<b>HAND TAP</b>	<b>2</b>	<b>3B</b>	<b>4</b>	<b>15888</b>	<b>15889</b>	\$28.40	\$28.00	\$27.20	\$22.60	\$19.20	\$16.50	\$15.40	\$13.50
<b>HAND TAP</b>	<b>3</b>	<b>2B</b>	<b>4</b>	<b>17615</b>	<b>17616</b>	\$33.80	\$33.30	\$32.40	\$27.10	\$25.50	\$20.40	\$16.50	\$14.70
R.H. ROUND DIE 1"OD				13132		\$87.00	\$65.40	\$57.70	\$39.60	\$37.70	\$34.40	\$29.50	\$29.30
<b>3/8"-48 NS</b>						<i>Recommended Hole Size based on 75% Thread = .355"</i>							
<b>HAND TAP</b>	<b>2</b>	<b>3B</b>	<b>4</b>	<b>15893</b>	<b>15894</b>	\$33.90	\$33.30	\$32.50	\$27.10	\$20.30	\$17.00	\$16.50	\$15.20
<b>13/32"-32 NS</b>						<i>Recommended Hole Size based on 75% Thread = .3759"</i>							
<b>HAND TAP</b>	<b>3</b>	<b>3B</b>	<b>4</b>	<b>15898</b>	<b>15899</b>	\$40.30	\$39.40	\$38.60	\$32.10	\$29.80	\$24.40	\$19.70	\$18.30
<b>7/16"-14 NC</b>						<i>Recommended Hole Size based on 75% Thread = .3681" for STI = .4531" / TRU-FLO at 65% Thread = .4059"</i>							
<b>L.H. HAND TAP</b>	<b>3</b>	<b>3B</b>	<b>4</b>	<b>15903</b>	<b>15904</b>	\$20.40	\$20.40	\$20.40	\$20.40	\$20.40	\$19.20	\$19.20	\$19.20
<b>L.H. SPIRAL POINT TAP</b>	<b>3</b>	<b>3B</b>	<b>3</b>	<b>15901</b>		\$44.80	\$43.90	\$43.00	\$35.90	\$27.20	\$24.40	\$21.80	\$20.70
<b>+.005 HAND TAP</b>	<b>11</b>	<b>PLATING</b>	<b>4</b>	<b>15908</b>	<b>15909</b>	\$20.40	\$20.40	\$20.40	\$20.40	\$20.40	\$19.20	\$19.20	\$19.20
<b>+.005 SPIRAL POINT TAP</b>	<b>11</b>	<b>PLATING</b>	<b>3</b>	<b>15906</b>		\$21.70	\$21.70	\$21.70	\$21.70	\$21.70	\$20.10	\$20.10	\$20.10
<b>6" EXTENSION HAND TAP</b>	<b>3</b>	<b>3B</b>	<b>4</b>	<b>15933</b>	<b>15934</b>	\$45.10	\$45.10	\$45.10	\$43.40	\$39.90	\$36.70	\$34.10	\$33.00
<b>6" EXTENSION SPIRAL POINT TAP</b>	<b>3</b>	<b>3B</b>	<b>3</b>	<b>15931</b>		\$46.60	\$46.60	\$46.60	\$44.90	\$41.30	\$38.20	\$35.60	\$34.40
<b>TRU-FLO FORM TAP</b>	<b>5</b>	<b>3B</b>		<b>19106</b>	<b>19107</b>	\$49.70	\$45.70	\$43.50	\$39.20	\$35.70	\$34.00	\$31.90	\$28.80
<b>TRU-FLO FORM TAP</b>	<b>8</b>	<b>2B</b>		<b>19108</b>	<b>19109</b>	\$49.70	\$45.70	\$43.50	\$39.20	\$35.70	\$34.00	\$31.90	\$28.80
<b>SOLID CARBIDE / HAND TAP</b>	<b>3</b>	<b>3B</b>	<b>4</b>	<b>41520</b>	<b>41521</b>	\$153.60	\$142.30	\$135.40	\$129.80	\$124.40	\$111.10	\$103.70	\$93.50



Click on Item Number  
for Catalog Listing

SIZE/ DESCRIPTION	GH #	CLASS OF FIT	# FLUTES	ITEM #		1 PC	2 PC	3 PC	6 PC	9 PC	12 PC	24 PC	48 PC
				PLUG	BOTTOM								
<b>7/16"-14 NC</b>						<i>See Previous Page for Recommended Hole Size</i>							
SOLID CARBIDE / SP PT TAP	3	3B	3	41522		\$157.00	\$145.70	\$138.80	\$131.50	\$126.10	\$112.80	\$105.30	\$95.10
COST CUTTER DRILL/TAP	3	3B	2	29018		\$33.60	\$33.60	\$33.60	\$33.60	\$33.60	\$33.60	\$33.60	\$33.60
STI HAND TAP	3	3B	4	17882	17883	\$33.40	\$32.10	\$30.60	\$29.60	\$28.90	\$27.10	\$27.00	\$26.30
STI SPIRAL POINT TAP	3	3B	3	17884		\$36.50	\$35.30	\$33.70	\$32.80	\$32.00	\$30.30	\$30.10	\$29.40
R.H. ROUND DIE 1-1/2"OD				13142		\$59.60	\$59.60	\$59.60	\$51.40	\$49.30	\$45.20	\$43.50	\$43.20
L.H. ROUND DIE 1-1/2"OD				13143		\$101.20	\$86.10	\$68.80	\$57.20	\$54.70	\$50.10	\$46.00	\$45.40
GAGE - Taperlock Style		2B		23148		\$99.60							
GAGE - Taperlock Style		3B		23149		\$99.60							
GAGE - Reversible Style		2B		24319		\$146.60							
GAGE - Reversible Style		3B		24320		\$146.60							
GAGE - Ring-Go		2A		23524		\$132.10							
GAGE - Ring-Go		3A		23525		\$132.10							
GAGE - Ring-NoGo		2A		23526		\$132.10							
GAGE - Ring-NoGo		3A		23527		\$132.10							
GAGE - STI Plug Taperlock Style		2B		24707		\$150.30							
GAGE - STI Plug Taperlock Style		3B		24708		\$150.30							
<b>7/16"-16 NS</b>						<i>Recommended Hole Size based on 75% Thread = .3769"</i>							
HAND TAP	3	3B	4	15938	15939	\$31.70	\$31.30	\$30.50	\$25.30	\$22.00	\$19.50	\$19.20	\$19.20
R.H. ROUND DIE 1-1/2"OD				13144		\$101.20	\$86.10	\$68.80	\$57.20	\$54.70	\$50.10	\$46.00	\$45.40
GAGE - Taperlock Style		2B		22225		\$195.50							
GAGE - Taperlock Style		3B		22226		\$195.50							
GAGE - Ring-Go		2A		22227		\$256.50							
GAGE - Ring-Go		3A		22228		\$256.50							
GAGE - Ring-NoGo		2A		22229		\$256.50							
GAGE - Ring-NoGo		3A		22230		\$256.50							
<b>7/16"-18 NS</b>						<i>Recommended Hole Size based on 75% Thread = .3839"</i>							
HAND TAP	3	3B	4	15943	15944	\$31.70	\$31.30	\$30.50	\$25.30	\$22.00	\$19.50	\$19.20	\$19.20
R.H. ROUND DIE 1-1/2"OD				13146		\$101.20	\$86.10	\$68.80	\$57.20	\$54.70	\$50.10	\$46.00	\$45.40
<b>7/16"-20 NF</b>						<i>Recommended Hole Size based on 75% Thread = .389" for STI = .4531" / TRU-FLO at 65% Thread = .4154"</i>							
L.H. HAND TAP	3	3B	4	15948	15949	\$20.40	\$20.40	\$20.40	\$20.40	\$20.40	\$19.50	\$19.20	\$19.20
HAND TAP	6		4	17741	17742	\$61.10	\$50.50	\$40.10	\$29.60	\$27.40	\$25.80	\$23.10	\$20.50
+.005 HAND TAP	11	PLATING	4	15963	15964	\$20.40	\$20.40	\$20.40	\$20.40	\$20.40	\$19.20	\$19.20	\$19.20
+.005 SPIRAL POINT TAP	11	PLATING	3	15961		\$21.70	\$21.70	\$21.70	\$21.70	\$21.70	\$20.10	\$20.10	\$20.10
6" PULLEY TAP	3	3B	4	15968	15969	\$44.50	\$44.50	\$44.50	\$44.50	\$42.40	\$40.00	\$36.60	\$33.00
6" EXTENSION HAND TAP	3	3B	4	15973	15974	\$44.50	\$44.50	\$44.50	\$44.50	\$42.40	\$40.00	\$36.60	\$33.00
6" EXTENSION SPIRAL POINT TAP	3	3B	3	15971		\$46.60	\$46.60	\$46.60	\$44.90	\$41.30	\$38.20	\$35.60	\$34.40
TRU-FLO FORM TAP	5	3B		19144	19145	\$49.70	\$45.70	\$43.50	\$39.20	\$35.70	\$34.00	\$31.90	\$28.80
TRU-FLO FORM TAP	8	2B		19146	19147	\$49.70	\$45.70	\$43.50	\$39.20	\$35.70	\$34.00	\$31.90	\$28.80
SOLID CARBIDE / HAND TAP	3	3B	4	41524	41525	\$153.60	\$142.30	\$135.40	\$129.80	\$124.40	\$111.10	\$103.70	\$93.50
SOLID CARBIDE / SP PT TAP	3	3B	3	41526		\$157.00	\$145.70	\$138.80	\$131.50	\$126.10	\$112.80	\$105.30	\$95.10
COST CUTTER DRILL/TAP	3	3B	2	29019		\$33.60	\$33.60	\$33.60	\$33.60	\$33.60	\$33.60	\$33.60	\$33.60
STI HAND TAP	3	3B	4	17886	17887	\$33.40	\$32.10	\$30.60	\$29.60	\$28.90	\$27.10	\$27.00	\$26.30
STI SPIRAL POINT TAP	3	3B	3	17888		\$36.50	\$35.30	\$33.70	\$32.80	\$32.00	\$30.30	\$30.10	\$29.40
R.H. ROUND DIE 1-1/2"OD				13148		\$59.60	\$59.60	\$59.60	\$51.40	\$49.30	\$45.20	\$43.50	\$43.20
L.H. ROUND DIE 1-1/2"OD				13149		\$101.20	\$86.10	\$68.80	\$57.20	\$54.70	\$50.10	\$46.00	\$45.40

TAPS, DIES & GAGES

Click on Item Number for Catalog Listing

SIZE/ DESCRIPTION	GH #	CLASS OF FIT	# FLUTES	ITEM #		1 PC	2 PC	3 PC	6 PC	9 PC	12 PC	24 PC	48 PC
				PLUG	BOTTOM								
<b>7/16"-20 NF</b>													
<i>See Previous Page for Recommended Hole Size</i>													
GAGE - Taperlock Style		2B		23153		\$99.60							
GAGE - Taperlock Style		3B		23154		\$99.60							
GAGE - Reversible Style		2B		24324		\$146.60							
GAGE - Reversible Style		3B		24325		\$146.60							
GAGE - Ring-Go		2A		23530		\$132.10							
GAGE - Ring-Go		3A		23531		\$132.10							
GAGE - Ring-NoGo		2A		23532		\$132.10							
GAGE - Ring-NoGo		3A		23533		\$132.10							
GAGE - STI Plug Taperlock Style		2B		24712		\$150.30							
GAGE - STI Plug Taperlock Style		3B		24713		\$150.30							
<b>7/16"-24 NS</b>													
<i>Recommended Hole Size based on 75% Thread = .3965"</i>													
HAND TAP	3	3B	4	15978	15979	\$31.70	\$31.30	\$30.50	\$27.40	\$22.00	\$19.50	\$19.20	\$19.20
HAND TAP	5	2B	4	15983	15984	\$38.40	\$37.90	\$36.80	\$30.80	\$28.50	\$24.40	\$19.70	\$19.70
R.H. ROUND DIE 1-1/2"OD				13150		\$101.20	\$86.10	\$68.80	\$57.20	\$54.70	\$50.10	\$46.00	\$45.40
GAGE - Taperlock Style		2B		22239		\$210.30							
GAGE - Taperlock Style		3B		22240		\$210.30							
GAGE - Ring-Go		2A		22241		\$271.30							
GAGE - Ring-Go		3A		22242		\$271.30							
GAGE - Ring-NoGo		2A		22243		\$271.30							
GAGE - Ring-NoGo		3A		22244		\$271.30							
<b>7/16"-27 NS</b>													
<i>Recommended Hole Size based on 75% Thread = .4015"</i>													
HAND TAP	3	3B	4	15988	15989	\$31.70	\$31.30	\$30.50	\$27.40	\$22.00	\$19.50	\$19.20	\$19.20
R.H. ROUND DIE 1-1/2"OD				13152		\$101.20	\$86.10	\$68.80	\$57.20	\$54.70	\$50.10	\$46.00	\$45.40
<b>7/16"-28 NEF</b>													
<i>Recommended Hole Size based on 75% Thread = .4028"</i>													
HAND TAP	3	3B	4	15993	15994	\$29.20	\$26.80	\$24.20	\$20.60	\$20.10	\$19.50	\$19.20	\$19.20
HAND TAP	5	2B	4	15998	15999	\$31.70	\$27.80	\$24.20	\$20.60	\$20.10	\$19.50	\$19.20	\$19.20
R.H. ROUND DIE 1-1/2"OD				13154		\$101.20	\$86.10	\$68.80	\$57.20	\$54.70	\$50.10	\$46.00	\$45.40
GAGE - Taperlock Style		2B		23158		\$197.00							
GAGE - Taperlock Style		3B		23159		\$197.00							
GAGE - Reversible Style		2B		24952		\$254.90							
GAGE - Reversible Style		3B		24953		\$254.90							
GAGE - Ring-Go		2A		23536		\$182.70							
GAGE - Ring-Go		3A		23537		\$182.70							
GAGE - Ring-NoGo		2A		23538		\$182.70							
GAGE - Ring-NoGo		3A		23539		\$182.70							
<b>7/16"-32 NS</b>													
<i>Recommended Hole Size based on 75% Thread = .4072"</i>													
HAND TAP	3	3B	4	16003	16004	\$31.70	\$31.30	\$30.50	\$27.40	\$22.00	\$19.50	\$19.20	\$19.20
R.H. ROUND DIE 1-1/2"OD				13156		\$101.20	\$86.10	\$68.80	\$57.20	\$54.70	\$50.10	\$46.00	\$45.40
GAGE - Taperlock Style		2B		22245		\$210.30							
GAGE - Taperlock Style		3B		22246		\$210.30							
GAGE - Ring-Go		2A		22247		\$294.40							
GAGE - Ring-Go		3A		22248		\$294.40							
GAGE - Ring-NoGo		2A		22249		\$294.40							
GAGE - Ring-NoGo		3A		22250		\$294.40							





Click on Item Number  
for Catalog Listing

SIZE/ DESCRIPTION	GH #	CLASS OF FIT	# FLUTES	ITEM #		1 PC	2 PC	3 PC	6 PC	9 PC	12 PC	24 PC	48 PC
				PLUG	BOTTOM								
<b>7/16"-40 NS</b>						<i>Recommended Hole Size based on 75% Thread = .4133"</i>							
HAND TAP	2	3B	4	16008	16009	\$31.70	\$31.30	\$30.50	\$27.40	\$22.00	\$19.50	\$19.20	\$19.20
R.H. ROUND DIE 1-1/2"OD				13158		\$101.20	\$86.10	\$68.80	\$57.20	\$54.70	\$50.10	\$46.00	\$45.40
<b>15/32"-32 NS</b>						<i>Recommended Hole Size based on 75% Thread = .4384"</i>							
HAND TAP	3	3B	6	16013	16014	\$45.30	\$44.60	\$43.50	\$39.20	\$32.40	\$27.20	\$21.80	\$20.90
SPIRAL POINT TAP	3	3B	3	16011		\$47.30	\$46.70	\$45.40	\$40.90	\$34.60	\$29.20	\$24.10	\$21.70
R.H. ROUND DIE 1-1/2"OD				13160		\$101.20	\$86.10	\$68.80	\$57.20	\$54.70	\$50.10	\$46.00	\$45.40
<b>1/2"-10 ACME</b>						<i>Recommended Hole Size = .4000"</i>							
HAND TAP		2G	4	16017		\$69.50	\$63.40	\$60.80	\$57.10	\$52.90	\$49.40	\$49.40	\$49.40
L.H. HAND TAP		2G	4	16021		\$69.50	\$63.40	\$60.80	\$57.10	\$52.90	\$49.40	\$49.40	\$49.40
TANDEM TAP		2G	4	16023		\$133.80	\$107.10	\$75.00	\$66.50	\$62.40	\$58.90	\$58.90	\$58.90
L.H. TANDEM TAP		2G	4	16024		\$152.20	\$121.80	\$85.70	\$70.60	\$64.80	\$59.60	\$59.60	\$59.60
<b>1/2"-12 NS</b>						<i>Recommended Hole Size based on 75% Thread = .4192"</i>							
HAND TAP	3	3B	4	16028	16029	\$37.10	\$36.60	\$35.70	\$30.60	\$24.70	\$22.00	\$21.80	\$21.20
R.H. ROUND DIE 1-1/2"OD				13162		\$101.20	\$86.10	\$68.80	\$57.20	\$54.70	\$50.10	\$46.00	\$45.40
<b>1/2"-12 BSW 55° MOD WHITWORTH</b>						<i>Recommended Hole Size = .4200"</i>							
	3		4	16033	16034	\$38.70	\$37.90	\$36.60	\$32.40	\$29.30	\$25.10	\$25.10	\$25.10
<b>1/2"-13 NC</b>						<i>Recommended Hole Size based on 75% Thread = .4251" for STI = .5312" / TRU-FLO at 65% Thread = .4660"</i>							
L.H. HAND TAP	3	3B	4	16038	16039	\$24.10	\$24.10	\$24.10	\$21.80	\$21.80	\$21.80	\$21.80	\$21.20
L.H. SPIRAL POINT TAP	3	3B	3	16036		\$26.30	\$26.30	\$26.30	\$24.10	\$24.10	\$24.10	\$24.10	\$23.20
+003 HAND TAP	7		4	16043	16044	\$44.90	\$44.30	\$43.10	\$35.90	\$26.10	\$22.00	\$21.80	\$21.20
+005 HAND TAP	11	PLATING	4	16048	16049	\$24.10	\$24.10	\$24.10	\$21.80	\$21.80	\$21.80	\$21.80	\$21.20
+005 SPIRAL POINT TAP	11	PLATING	3	16046		\$26.30	\$26.30	\$26.30	\$24.10	\$24.10	\$24.10	\$24.10	\$23.20
+010 HAND TAP	21		4	16053	16054	\$44.90	\$44.30	\$43.10	\$35.90	\$26.10	\$22.00	\$21.80	\$21.20
DOUBLE LEAD TAP	3	3B	4	16058	16059	\$44.90	\$44.30	\$43.10	\$37.90	\$37.90	\$37.90	\$37.00	\$31.40
6" EXTENSION HAND TAP	3	3B	4	16083	16084	\$36.10	\$36.10	\$36.10	\$36.10	\$36.10	\$36.10	\$36.10	\$36.10
6" EXTENSION SPIRAL POINT TAP	3	3B	3	16081		\$38.10	\$38.10	\$38.10	\$38.10	\$38.10	\$38.10	\$38.10	\$38.10
8" EXTENSION HAND TAP	3	3B	4	17973	17974	\$79.30	\$68.80	\$58.40	\$47.90	\$44.40	\$42.70	\$40.10	\$37.50
10" EXTENSION HAND TAP	3	3B	4	17978	17979	\$82.90	\$72.50	\$62.00	\$51.60	\$48.00	\$46.30	\$43.70	\$41.10
12" EXTENSION HAND TAP	3	3B	4	17983	17984	\$108.90	\$77.60	\$67.10	\$56.70	\$53.10	\$51.50	\$48.90	\$46.20
TRU-FLO FORM TAP	5	3B		19110	19111	\$49.70	\$45.70	\$43.50	\$39.20	\$35.70	\$34.00	\$31.90	\$28.80
TRU-FLO FORM TAP	8	2B		19112	19113	\$49.70	\$45.70	\$43.50	\$39.20	\$35.70	\$34.00	\$31.90	\$28.80
SOLID CARBIDE / HAND TAP	3	3B	4	41528	41529	\$172.30	\$172.30	\$172.30	\$166.60	\$151.10	\$148.60	\$138.80	\$137.50
SOLID CARBIDE / SP PT TAP	3	3B	3	41530		\$175.80	\$175.80	\$175.80	\$168.30	\$152.60	\$150.20	\$140.50	\$139.00
COST CUTTER DRILL/TAP	3	3B	2	29020		\$37.90	\$37.90	\$37.90	\$37.90	\$37.90	\$37.90	\$37.90	\$37.90
TIN COAT/SP PT+.005 TAP	11	PLATING	3	50017		\$30.90	\$30.90	\$30.90	\$28.70	\$28.70	\$28.70	\$28.70	\$27.80
TIN COAT HAND x 6" TAP	3	3B	4	50019		\$43.40	\$43.40	\$43.40	\$43.40	\$43.40	\$43.40	\$43.40	\$43.40
TIN COAT/SP PT x 6" TAP	3	3B	3	50018		\$45.40	\$45.40	\$45.40	\$45.40	\$45.40	\$45.40	\$45.40	\$45.40
STI HAND TAP	3	3B	4	17890	17891	\$39.70	\$38.40	\$36.80	\$35.90	\$35.20	\$33.40	\$33.30	\$32.30
STI SPIRAL POINT TAP	3	3B	3	17892		\$42.80	\$41.50	\$40.00	\$39.00	\$38.30	\$36.50	\$36.40	\$35.50
R.H. ROUND DIE 1-1/2"OD				13164		\$59.60	\$59.60	\$59.60	\$51.40	\$49.30	\$45.20	\$43.50	\$43.20
L.H. ROUND DIE 1-1/2"OD				13165		\$101.20	\$86.10	\$68.80	\$57.20	\$54.70	\$50.10	\$46.00	\$45.40
GAGE - Taperlock Style		2B		23163		\$103.10							
GAGE - Taperlock Style		3B		23164		\$103.10							
GAGE - Reversible Style		2B		24329		\$154.00							



TAPS, DIES & GAGES

Click on Item Number for Catalog Listing

SIZE/ DESCRIPTION	GH #	CLASS OF FIT	# FLUTES	ITEM #		1 PC	2 PC	3 PC	6 PC	9 PC	12 PC	24 PC	48 PC
				PLUG	BOTTOM								
<b>1/2"-13 NC</b>				<i>See Previous Page for Recommended Hole Size</i>									
GAGE - Reversible Style		3B		24330		\$154.00							
GAGE - Ring-Go		2A		23542		\$139.20							
GAGE - Ring-Go		3A		23543		\$139.20							
GAGE - Ring-NoGo		2A		23544		\$139.20							
GAGE - Ring-NoGo		3A		23545		\$139.20							
GAGE - STI Plug Taperlock Style		2B		24717		\$168.30							
GAGE - STI Plug Taperlock Style		3B		24718		\$168.30							
<b>1/2"-14 PIPE TAP NPSI NPSF NPT/F NPS</b>				<i>Recommended Hole Size: NPT/NPTF = .703" NPSF/NPSI = .7188"</i>									
NPT/F REG. SPR FLT TAPER TAP			4	16086		\$82.10	\$82.10	\$82.10	\$82.10	\$82.10	\$75.70	\$74.60	\$71.00
NPT/F LEFT HAND TAPER TAP			4	16089		\$82.20	\$80.90	\$78.90	\$65.70	\$51.90	\$41.30	\$39.40	\$36.60
NPT/F 6" EXTENSION TAPER TAP			4	16092		\$60.20	\$60.20	\$60.20	\$56.50	\$52.90	\$51.30	\$48.60	\$46.00
NPT/F 6" EXTENSION INT TAPER TAP			5	16095		\$104.40	\$101.30	\$100.50	\$99.40	\$89.30	\$83.10	\$79.10	\$77.30
NPSF EXT x 6" TAP			4	17720		\$111.40	\$90.50	\$80.10	\$69.80	\$66.10	\$64.40	\$61.80	\$59.20
NPT/F 8" EXTENSION TAPER TAP			4	16098		\$100.40	\$96.20	\$85.70	\$75.30	\$71.70	\$70.10	\$67.50	\$64.80
NPT/F 10" EXTENSION TAPER TAP			4	17987		\$129.70	\$107.30	\$96.80	\$86.40	\$82.80	\$81.10	\$78.50	\$75.90
NPT/F CARB-I SERT TAP			4	41809		\$450.40	\$411.40	\$386.00	\$357.10	\$347.70	\$331.60	\$312.90	\$308.50
NPT/F COST CUTTER DRILL/TAP			4	29044		\$166.50	\$162.20	\$159.20	\$156.30	\$151.60	\$148.90	\$142.70	\$138.90
NPSI STRAIGHT TAP			4	16104		\$91.10	\$89.80	\$87.40	\$72.90	\$54.70	\$45.60	\$44.90	\$43.90
NPT R.H. ROUND DIE 2"OD				13184		\$124.80	\$104.70	\$98.30	\$76.10	\$76.10	\$76.10	\$76.10	\$76.10
NPS R.H. ROUND DIE 2"OD				13186		\$247.30	\$208.50	\$131.10	\$114.10				
GAGE L1 NPT PLG w/handle				24380		\$112.50							
GAGE L1 NPT RING				24378		\$197.30							
GAGE L1 NPTF PLG w/handle				24450		\$165.90							
GAGE L3 NPTF PLG w/handle				24452		\$165.90							
GAGE NPTF 6 step Plain Plug w/handle				24540		\$212.20							
GAGE L1 NPTF RING				24502		\$204.80							
GAGE L2 NPTF RING				24504		\$324.60							
GAGE NPTF 6 step Plain Ring				24574		\$341.20							
<b>1/2"-14 55° WHITWORTH PIPE</b>				<i>Recommended Hole Size: BSPT = .7188" / BSPP = .7344"</i>									
BSPT TAPER - MODIFIED TAP			4	16107	16108	\$52.70	\$50.70	\$50.70	\$47.10	\$44.70	\$44.70	\$44.70	\$44.70
BSPP PARALLEL - MODIFIED TAP			4	16110	16111	\$52.70	\$50.70	\$50.70	\$47.10	\$44.70	\$44.70	\$44.70	\$44.70
BSPT TAPER - FULL FORM TAP			4	17935		\$128.80	\$120.50	\$114.50	\$108.00	\$101.80	\$100.20	\$97.50	\$94.90
BSPP PARALLEL - FULL FORM TAP			4	17926		\$128.80	\$120.50	\$114.50	\$108.00	\$101.80	\$100.20	\$97.50	\$94.90
BSPT FULL FORM DIE 2"OD				13698		\$418.90							
BSPP FULL FORM DIE 2"OD				13699		\$178.70							
GAGE BSPT-Mod. w/handle				27011		\$319.70							
GAGE BSPP-Mod. DBL END w/handle				27050		\$378.70							



Click on Item Number  
for Catalog Listing

SIZE/ DESCRIPTION	GH #	CLASS OF FIT	# FLUTES	ITEM #		1 PC	2 PC	3 PC	6 PC	9 PC	12 PC	24 PC	48 PC
				PLUG	BOTTOM								
<b>1/2"-14 NS</b>													
<i>Recommended Hole Size based on 75% Thread = .4306"</i>													
HAND TAP	3	3B	4	16115	16116	\$36.70	\$36.50	\$35.60	\$30.40	\$24.70	\$22.00	\$21.80	\$21.20
R.H. ROUND DIE 1-1/2"OD				13166		\$101.20	\$86.10	\$68.80	\$57.20	\$54.70	\$50.10	\$46.00	\$45.40
<b>1/2"-16 NS</b>													
<i>Recommended Hole Size based on 75% Thread = .4394"</i>													
HAND TAP	3	3B	4	16120	16121	\$36.70	\$36.50	\$35.60	\$30.40	\$24.70	\$22.00	\$21.80	\$21.20
R.H. ROUND DIE 1-1/2"OD				13168		\$101.20	\$86.10	\$68.80	\$57.20	\$54.70	\$50.10	\$46.00	\$45.40
GAGE - Taperlock Style		2B		22259		\$195.50							
GAGE - Taperlock Style		3B		22260		\$195.50							
GAGE - Ring-Go		2A		22261		\$256.50							
GAGE - Ring-Go		3A		22262		\$256.50							
GAGE - Ring-NoGo		2A		22263		\$256.50							
GAGE - Ring-NoGo		3A		22264		\$256.50							
<b>1/2"-18 NS</b>													
<i>Recommended Hole Size based on 75% Thread = .4464"</i>													
HAND TAP	3	3B	4	16125	16126	\$36.70	\$36.50	\$35.60	\$30.40	\$24.70	\$22.00	\$21.80	\$21.20
R.H. ROUND DIE 1-1/2"OD				13170		\$101.20	\$86.10	\$68.80	\$57.20	\$54.70	\$50.10	\$46.00	\$45.40
<b>1/2"-20 NF</b>													
<i>Recommended Hole Size based on 75% Thread = .4515" for STI = .5156" / TRU-FLO at 65% Thread = .4779"</i>													
L.H. HAND TAP	3	3B	4	16130	16131	\$24.10	\$24.10	\$24.10	\$21.80	\$21.80	\$21.80	\$21.80	\$21.20
L.H. SPIRAL POINT TAP	3	3B	3	16128		\$28.70	\$28.70	\$28.70	\$28.70	\$27.30	\$27.30	\$24.10	\$23.20
HAND TAP	5	2B	4		17634	\$39.10	\$37.00	\$35.60	\$29.70	\$28.20	\$26.80	\$21.80	\$21.20
+.003 HAND TAP	7		4	16135	16136	\$40.00	\$39.40	\$38.40	\$33.00	\$25.70	\$23.20	\$21.80	\$21.20
+.005 HAND TAP	11	PLATING	4	16140	16141	\$24.10	\$24.10	\$24.10	\$21.80	\$21.80	\$21.80	\$21.80	\$21.20
+.005 SPIRAL POINT TAP	11	PLATING	3	16138		\$26.30	\$26.30	\$26.30	\$24.10	\$24.10	\$24.10	\$24.10	\$23.20
6" PULLEY TAP	3	3B	4	16145	16146	\$45.00	\$45.00	\$45.00	\$41.80	\$38.30	\$36.60	\$34.00	\$31.40
6" EXTENSION HAND TAP	3	3B	4	16150	16151	\$45.00	\$45.00	\$45.00	\$41.80	\$38.30	\$36.60	\$34.00	\$31.40
6" EXTENSION SPIRAL POINT TAP	3	3B	3	16148		\$45.00	\$42.90	\$41.80	\$41.00	\$38.10	\$38.10	\$38.10	\$38.10
TRU-FLO FORM TAP	5	3B		19114	19115	\$49.70	\$45.70	\$43.50	\$39.20	\$35.70	\$34.00	\$31.90	\$28.80
TRU-FLO FORM TAP	8	2B		19116	19117	\$49.70	\$45.70	\$43.50	\$39.20	\$35.70	\$34.00	\$31.90	\$28.80
TRU-FLO FORM TAP	10	PLATING		19118	19119	\$49.70	\$45.70	\$43.50	\$39.20	\$35.70	\$34.00	\$31.90	\$28.80
SOLID CARBIDE / HAND TAP	3	3B	4	41532	41533	\$177.70	\$177.70	\$177.70	\$172.10	\$156.50	\$154.10	\$144.30	\$142.90
SOLID CARBIDE / SP PT TAP	3	3B	3	41534		\$181.30	\$181.30	\$181.30	\$173.70	\$158.10	\$155.70	\$145.90	\$144.50
COST CUTTER DRILL/TAP	3	3B	2	29022		\$37.90	\$37.90	\$37.90	\$37.90	\$37.90	\$37.90	\$37.90	\$37.90
STI HAND TAP	3	3B	4	17894	17895	\$39.70	\$38.40	\$36.80	\$35.90	\$35.20	\$33.40	\$33.30	\$32.30
STI SPIRAL POINT TAP	3	3B	3	17896		\$42.80	\$41.50	\$40.00	\$39.00	\$38.30	\$36.50	\$36.40	\$35.50
R.H. ROUND DIE 1-1/2"OD				13172		\$59.60	\$59.60	\$59.60	\$51.40	\$49.30	\$45.20	\$43.50	\$43.20
L.H. ROUND DIE 1-1/2"OD				13173		\$101.20	\$86.10	\$68.80	\$57.20	\$54.70	\$50.10	\$46.00	\$45.40
GAGE - Taperlock Style		2B		23168		\$103.10							
GAGE - Taperlock Style		3B		23169		\$103.10							
GAGE - Reversible Style		2B		24334		\$154.00							
GAGE - Reversible Style		3B		24335		\$154.00							
GAGE - Ring-Go		2A		23548		\$139.20							
GAGE - Ring-Go		3A		23549		\$139.20							
GAGE - Ring-NoGo		2A		23550		\$139.20							
GAGE - Ring-NoGo		3A		23551		\$139.20							
GAGE - STI Plug Taperlock Style		2B		24722		\$168.30							
GAGE - STI Plug Taperlock Style		3B		24723		\$168.30							

TAPS, DIES & GAGES

Click on Item Number for Catalog Listing

SIZE/ DESCRIPTION	GH #	CLASS OF FIT	# FLUTES	ITEM #		1 PC	2 PC	3 PC	6 PC	9 PC	12 PC	24 PC	48 PC
				PLUG	BOTTOM								
<b>1/2"-24 NS</b>													
<i>Recommended Hole Size based on 75% Thread = .459"</i>													
HAND TAP	3	3B	4	16155	16156	\$36.70	\$36.50	\$35.60	\$30.40	\$24.70	\$22.00	\$21.80	\$21.20
R.H. ROUND DIE 1-1/2"OD				13174		\$101.20	\$86.10	\$68.80	\$57.20	\$54.70	\$50.10	\$46.00	\$45.40
<b>1/2"-27 NS</b>													
<i>Recommended Hole Size based on 75% Thread = .464"</i>													
HAND TAP	3	3B	4	16160	16161	\$36.70	\$36.50	\$35.60	\$30.40	\$24.70	\$22.00	\$21.80	\$21.20
R.H. ROUND DIE 1-1/2"OD				13176		\$101.20	\$86.10	\$68.80	\$57.20	\$54.70	\$50.10	\$46.00	\$45.40
<b>1/2"-28 NEF</b>													
<i>Recommended Hole Size based on 75% Thread = .4653"</i>													
HAND TAP	3	3B	4	16165	16166	\$31.50	\$29.00	\$23.80	\$17.70	\$15.20	\$14.40	\$14.40	\$14.40
SPIRAL POINT TAP	3	3B	3	16163		\$33.70	\$31.20	\$28.80	\$21.80	\$21.20	\$20.00	\$19.70	\$18.90
HAND TAP	5	2B	4	16170	16171	\$34.30	\$30.30	\$23.80	\$22.50	\$21.60	\$20.10	\$19.90	\$19.50
R.H. ROUND DIE 1-1/2"OD				13178		\$101.20	\$86.10	\$68.80	\$57.20	\$54.70	\$50.10	\$46.00	\$45.40
GAGE - Taperlock Style		2B		23173		\$193.60							
GAGE - Taperlock Style		3B		23174		\$193.60							
GAGE - Reversible Style		2B		24957		\$269.60							
GAGE - Reversible Style		3B		24958		\$269.60							
GAGE - Ring-Go		2A		23554		\$184.60							
GAGE - Ring-Go		3A		23555		\$184.60							
GAGE - Ring-NoGo		2A		23556		\$184.60							
GAGE - Ring-NoGo		3A		23557		\$184.60							
<b>1/2"-32 NS</b>													
<i>Recommended Hole Size based on 75% Thread = .4697"</i>													
HAND TAP	3	3B	6	16175	16176	\$36.70	\$36.50	\$35.60	\$30.40	\$24.70	\$22.00	\$21.80	\$21.20
R.H. ROUND DIE 1-1/2"OD				13180		\$101.20	\$86.10	\$68.80	\$57.20	\$54.70	\$50.10	\$46.00	\$45.40
GAGE - Taperlock Style		2B		22273		\$225.20							
GAGE - Taperlock Style		3B		22274		\$225.20							
GAGE - Ring-Go		2A		22275		\$294.40							
GAGE - Ring-Go		3A		22276		\$294.40							
GAGE - Ring-NoGo		2A		22277		\$294.40							
GAGE - Ring-NoGo		3A		22278		\$294.40							
<b>1/2"-40 NS</b>													
<i>Recommended Hole Size based on 75% Thread = .4758"</i>													
HAND TAP	2	3B	6	16180	16181	\$36.70	\$36.50	\$35.60	\$30.40	\$24.70	\$22.00	\$21.80	\$21.20
R.H. ROUND DIE 1-1/2"OD				13182		\$101.20	\$86.10	\$68.80	\$57.20	\$54.70	\$50.10	\$46.00	\$45.40
<b>33/64"-13 NS</b>													
<i>Recommended Hole Size based on 75% Thread = .4407"</i>													
HAND TAP	3	3B	4	16185	16186	\$47.20	\$46.40	\$45.30	\$37.80	\$32.40	\$27.20	\$22.70	\$21.20
<b>9/16"-12 NC</b>													
<i>Recommended Hole Size based on 75% Thread = .4817"</i> <i>TRU-FLO at 65% Thread = .5257"</i>													
L.H. HAND TAP	3	3B	4	16190	16191	\$32.30	\$32.30	\$27.70	\$27.70	\$27.70	\$27.70	\$27.70	\$27.30
SPIRAL POINT TAP	3	3B	3	18331		\$37.00	\$33.60	\$32.30	\$31.80	\$31.30	\$31.00	\$30.60	\$30.00
6" EXTENSION HAND TAP	3	3B	4	17653	17654	\$84.60	\$64.00	\$53.60	\$43.10	\$39.60	\$37.90	\$35.30	\$32.70
TRU-FLO FORM TAP	7	3B		19120	19121	\$53.20	\$49.30	\$47.10	\$42.80	\$39.20	\$37.60	\$35.50	\$32.30
TRU-FLO FORM TAP	10	2B		19122	19123	\$53.20	\$49.30	\$47.10	\$42.80	\$39.20	\$37.60	\$35.50	\$32.30
SOLID CARBIDE TAP	3	3B	4	47201	47202	\$245.00	\$213.10	\$206.30	\$195.70	\$193.50	\$191.30	\$188.70	\$187.30
R.H. ROUND DIE 1-1/2"OD				13188		\$59.60	\$59.60	\$59.60	\$51.40	\$49.30	\$45.20	\$43.50	\$43.20
L.H. ROUND DIE 1-1/2"OD				13189		\$101.20	\$86.10	\$68.80	\$57.20	\$54.70	\$50.10	\$46.00	\$45.40
GAGE - Taperlock Style		2B		23178		\$132.10							
GAGE - Taperlock Style		3B		23179		\$132.10							
GAGE - Reversible Style		2B		24339		\$170.10							
GAGE - Reversible Style		3B		24340		\$170.10							



Click on Item Number  
for Catalog Listing

SIZE/ DESCRIPTION	GH #	CLASS OF FIT	# FLUTES	ITEM #		1 PC	2 PC	3 PC	6 PC	9 PC	12 PC	24 PC	48 PC
				PLUG	BOTTOM								
<b>9/16"-12 NC</b>													
<i>See Previous Page for Recommended Hole Size</i>													
GAGE - Ring-Go		2A		23560		\$155.70							
GAGE - Ring-Go		3A		23561		\$155.70							
GAGE - Ring-NoGo		2A		23562		\$155.70							
GAGE - Ring-NoGo		3A		23563		\$155.70							
GAGE - STI Plug Taperlock Style		2B		22279		\$149.30							
GAGE - STI Plug Taperlock Style		3B		22280		\$149.30							
<b>9/16"-16 NS</b>													
<i>Recommended Hole Size based on 75% Thread = .5019"</i>													
<b>HAND TAP</b>	<b>3</b>	<b>3B</b>	<b>4</b>	<b>16200</b>	<b>16201</b>	<b>\$40.80</b>	<b>\$40.30</b>	<b>\$39.10</b>	<b>\$32.40</b>	<b>\$29.40</b>	<b>\$28.30</b>	<b>\$27.60</b>	<b>\$27.30</b>
R.H. ROUND DIE 1-1/2"OD				13190		\$101.20	\$86.10	\$68.80	\$57.20	\$54.70	\$50.10	\$46.00	\$45.40
GAGE - Taperlock Style		2B		22289		\$180.40							
GAGE - Taperlock Style		3B		22290		\$180.40							
GAGE - Ring-Go		2A		22291		\$264.60							
GAGE - Ring-Go		3A		22292		\$264.60							
GAGE - Ring-NoGo		2A		22293		\$264.60							
GAGE - Ring-NoGo		3A		22294		\$264.60							
<b>9/16"-18 NF</b>													
<i>Recommended Hole Size based on 75% Thread = .5089" TRU-FLO at 65% Thread = .5279"</i>													
<b>L.H. HAND TAP</b>	<b>3</b>	<b>3B</b>	<b>4</b>	<b>16205</b>	<b>16206</b>	<b>\$30.60</b>	<b>\$30.60</b>	<b>\$27.70</b>	<b>\$27.70</b>	<b>\$27.70</b>	<b>\$27.70</b>	<b>\$27.70</b>	<b>\$27.30</b>
<b>SPIRAL POINT TAP</b>	<b>3</b>	<b>3B</b>	<b>3</b>	<b>18337</b>		<b>\$37.00</b>	<b>\$33.60</b>	<b>\$32.30</b>	<b>\$31.80</b>	<b>\$31.30</b>	<b>\$31.00</b>	<b>\$30.60</b>	<b>\$30.00</b>
<b>HAND TAP</b>	<b>5</b>	<b>2B</b>	<b>4</b>	<b>18375</b>	<b>17769</b>	<b>\$50.70</b>	<b>\$49.70</b>	<b>\$48.70</b>	<b>\$40.60</b>	<b>\$35.20</b>	<b>\$29.70</b>	<b>\$27.60</b>	<b>\$27.30</b>
<b>SPIRAL POINT TAP</b>	<b>5</b>	<b>2B</b>	<b>3</b>	<b>17655</b>		<b>\$89.30</b>	<b>\$69.90</b>	<b>\$59.40</b>	<b>\$49.00</b>	<b>\$43.30</b>	<b>\$32.30</b>	<b>\$30.60</b>	<b>\$30.00</b>
<b>+ .005 HAND TAP</b>	<b>11</b>	<b>PLATING</b>	<b>4</b>	<b>16215</b>	<b>16216</b>	<b>\$50.70</b>	<b>\$49.70</b>	<b>\$48.70</b>	<b>\$40.60</b>	<b>\$35.20</b>	<b>\$29.70</b>	<b>\$27.60</b>	<b>\$27.30</b>
<b>+ .005 SPIRAL POINT TAP</b>	<b>11</b>	<b>PLATING</b>	<b>3</b>	<b>16213</b>		<b>\$51.50</b>	<b>\$50.50</b>	<b>\$50.10</b>	<b>\$41.80</b>	<b>\$36.50</b>	<b>\$32.30</b>	<b>\$30.60</b>	<b>\$30.00</b>
<b>6" EXTENSION HAND TAP</b>	<b>3</b>	<b>3B</b>	<b>4</b>	<b>16220</b>	<b>16221</b>	<b>\$81.50</b>	<b>\$68.20</b>	<b>\$57.70</b>	<b>\$47.30</b>	<b>\$43.70</b>	<b>\$42.10</b>	<b>\$39.40</b>	<b>\$36.80</b>
<b>TRU-FLO FORM TAP</b>	<b>7</b>	<b>3B</b>		<b>19124</b>	<b>19125</b>	<b>\$53.20</b>	<b>\$49.30</b>	<b>\$47.10</b>	<b>\$42.80</b>	<b>\$39.20</b>	<b>\$37.60</b>	<b>\$35.50</b>	<b>\$32.30</b>
<b>TRU-FLO FORM TAP</b>	<b>10</b>	<b>2B</b>		<b>19126</b>	<b>19127</b>	<b>\$53.20</b>	<b>\$49.30</b>	<b>\$47.10</b>	<b>\$42.80</b>	<b>\$39.20</b>	<b>\$37.60</b>	<b>\$35.50</b>	<b>\$32.30</b>
<b>SOLID CARBIDE TAP</b>	<b>3</b>	<b>3B</b>	<b>4</b>	<b>47204</b>	<b>47205</b>	<b>\$245.00</b>	<b>\$213.10</b>	<b>\$206.30</b>	<b>\$195.70</b>	<b>\$193.50</b>	<b>\$191.30</b>	<b>\$188.70</b>	<b>\$187.30</b>
R.H. ROUND DIE 1-1/2"OD				13192		\$59.60	\$59.60	\$59.60	\$51.40	\$49.30	\$45.20	\$43.50	\$43.20
L.H. ROUND DIE 1-1/2"OD				13193		\$101.20	\$86.10	\$68.80	\$57.20	\$54.70	\$50.10	\$46.00	\$45.40
GAGE - Taperlock Style		2B		23183		\$132.10							
GAGE - Taperlock Style		3B		23184		\$132.10							
GAGE - Reversible Style		2B		24344		\$170.10							
GAGE - Reversible Style		3B		24345		\$170.10							
GAGE - Ring-Go		2A		23566		\$155.70							
GAGE - Ring-Go		3A		23567		\$155.70							
GAGE - Ring-NoGo		2A		23568		\$155.70							
GAGE - Ring-NoGo		3A		23569		\$155.70							
GAGE - STI Plug Taperlock Style		2B		22295		\$146.60							
GAGE - STI Plug Taperlock		3B		22296		\$146.60							
<b>9/16"-20 NS</b>													
<i>Recommended Hole Size based on 75% Thread = .514"</i>													
<b>HAND TAP</b>	<b>3</b>	<b>3B</b>	<b>4</b>	<b>16225</b>	<b>16226</b>	<b>\$45.20</b>	<b>\$40.30</b>	<b>\$39.10</b>	<b>\$32.40</b>	<b>\$29.40</b>	<b>\$28.30</b>	<b>\$27.60</b>	<b>\$27.30</b>
<b>SPIRAL POINT TAP</b>	<b>3</b>	<b>3B</b>	<b>3</b>	<b>16223</b>		<b>\$47.10</b>	<b>\$43.90</b>	<b>\$41.20</b>	<b>\$40.50</b>	<b>\$36.90</b>	<b>\$32.30</b>	<b>\$30.60</b>	<b>\$30.00</b>
R.H. ROUND DIE 1-1/2"OD				13194		\$101.20	\$86.10	\$68.80	\$57.20	\$54.70	\$50.10	\$46.00	\$45.40
GAGE - Taperlock Style		2B		22305		\$195.50							
GAGE - Taperlock Style		3B		22306		\$195.50							
GAGE - Ring-Go		2A		22307		\$271.30							
GAGE - Ring-Go		3A		22308		\$271.30							

TAPS, DIES & GAGES

Click on Item Number for Catalog Listing

SIZE/ DESCRIPTION	GH #	CLASS OF FIT	# FLUTES	ITEM #		1 PC	2 PC	3 PC	6 PC	9 PC	12 PC	24 PC	48 PC
				PLUG	BOTTOM								
<b>9/16"-20 NS</b>						<i>See Previous Page for Recommended Hole Size</i>							
GAGE - Ring-NoGo		2A		22309		\$271.30							
GAGE - Ring-NoGo		3A		22310		\$271.30							
<b>9/16"-24 NEF</b>						<i>Recommended Hole Size based on 75% Thread = .5215"</i>							
<b>HAND TAP</b>	<b>3</b>	<b>3B</b>	<b>4</b>	<b>16230</b>	<b>16231</b>	\$34.60	\$30.30	\$26.10	\$19.70	\$18.00	\$17.20	\$17.20	\$17.20
<b>HAND TAP</b>	<b>5</b>	<b>2B</b>	<b>4</b>	<b>16235</b>	<b>16236</b>	\$34.60	\$32.10	\$31.30	\$26.20	\$21.20	\$19.20	\$17.90	\$17.70
R.H. ROUND DIE 1-1/2"OD				13196		\$101.20	\$86.10	\$68.80	\$57.20	\$54.70	\$50.10	\$46.00	\$45.40
GAGE - Taperlock Style		2B		23188		\$197.00							
GAGE - Taperlock Style		3B		23189		\$197.00							
GAGE - Reversible Style		2B		24962		\$300.10							
GAGE - Reversible Style		3B		24963		\$300.10							
GAGE - Ring-Go		2A		23572		\$191.90							
GAGE - Ring-Go		3A		23573		\$191.90							
GAGE - Ring-NoGo		2A		23574		\$191.90							
GAGE - Ring-NoGo		3A		23575		\$191.90							
<b>9/16"-27 NS</b>						<i>Recommended Hole Size based on 75% Thread = .5265"</i>							
<b>HAND TAP</b>	<b>3</b>	<b>3B</b>	<b>6</b>	<b>16240</b>	<b>16241</b>	\$45.20	\$40.30	\$39.10	\$32.40	\$29.40	\$28.30	\$27.60	\$27.30
R.H. ROUND DIE 1-1/2"OD				13198		\$101.20	\$86.10	\$68.80	\$57.20	\$54.70	\$50.10	\$46.00	\$45.40
<b>9/16"-32 NS</b>						<i>Recommended Hole Size based on 75% Thread = .5322"</i>							
<b>HAND TAP</b>	<b>3</b>	<b>3B</b>	<b>6</b>	<b>16245</b>	<b>16246</b>	\$45.20	\$40.30	\$39.10	\$32.40	\$29.40	\$28.30	\$27.60	\$27.30
R.H. ROUND DIE 1-1/2"OD				13200		\$101.20	\$86.10	\$68.80	\$57.20	\$54.70	\$50.10	\$46.00	\$45.40
GAGE - Taperlock Style		2B		22311		\$240.20							
GAGE - Taperlock Style		3B		22312		\$240.20							
GAGE - Ring-Go		2A		22313		\$302.60							
GAGE - Ring-Go		3A		22314		\$302.60							
GAGE - Ring-NoGo		2A		22315		\$302.60							
GAGE - Ring-NoGo		3A		22316		\$302.60							
<b>5/8"-8 ACME</b>						<i>Recommended Hole Size = .5000"</i>							
<b>HAND TAP</b>		<b>2G</b>	<b>4</b>	<b>16249</b>		\$82.30	\$74.10	\$72.30	\$60.20	\$47.50	\$43.50	\$41.80	\$39.40
<b>L.H. HAND TAP</b>		<b>2G</b>	<b>4</b>	<b>16253</b>		\$82.30	\$74.10	\$72.30	\$60.20	\$47.50	\$43.50	\$41.80	\$39.40
<b>TANDEM TAP</b>		<b>2G</b>	<b>4</b>	<b>16255</b>		\$160.40	\$128.30	\$89.90	\$73.90	\$62.60	\$57.00	\$57.00	\$57.00
<b>L.H. TANDEM TAP</b>		<b>2G</b>	<b>4</b>	<b>16256</b>		\$160.40	\$128.30	\$89.90	\$73.90	\$62.60	\$57.00	\$57.00	\$57.00
<b>5/8"-11 NC</b>						<i>Recommended Hole Size based on 75% Thread = .5365" TRU-FLO at 65% Thread = .5848"</i>							
<b>REGULAR SPIRAL FLUTE TAP</b>	<b>3</b>	<b>3B</b>	<b>4</b>	<b>16284</b>	<b>16285</b>	\$75.60	\$74.10	\$68.10	\$56.70	\$41.50	\$39.80	\$39.80	\$39.80
<b>FAST SPIRAL FLUTE TAP</b>	<b>3</b>	<b>3B</b>	<b>4</b>	<b>17717</b>	<b>17718</b>	\$75.50	\$67.00	\$56.60	\$46.10	\$42.60	\$40.90	\$38.30	\$35.70
<b>L.H. HAND TAP</b>	<b>3</b>	<b>3B</b>	<b>4</b>	<b>16270</b>	<b>16271</b>	\$38.90	\$37.80	\$36.60	\$36.10	\$35.50	\$34.00	\$33.20	\$32.00
<b>L.H. SPIRAL POINT TAP</b>	<b>3</b>	<b>3B</b>	<b>3</b>	<b>16268</b>		\$41.60	\$40.50	\$39.30	\$37.80	\$38.20	\$36.70	\$35.90	\$34.70
<b>+.005 HAND TAP</b>	<b>11</b>	<b>PLATING</b>	<b>4</b>	<b>16275</b>	<b>16276</b>	\$31.40	\$31.40	\$29.80	\$29.80	\$29.80	\$29.80	\$29.80	\$28.80
<b>+.005 SPIRAL POINT TAP</b>	<b>11</b>	<b>PLATING</b>	<b>3</b>	<b>16273</b>		\$34.40	\$34.40	\$31.60	\$31.60	\$31.60	\$31.60	\$31.60	\$30.60
<b>+.010 HAND TAP</b>	<b>21</b>		<b>4</b>	<b>16280</b>	<b>16281</b>	\$59.00	\$58.20	\$56.70	\$47.30	\$35.50	\$29.60	\$29.10	\$27.50
<b>6" EXTENSION HAND TAP</b>	<b>3</b>	<b>3B</b>	<b>4</b>	<b>16309</b>	<b>16310</b>	\$70.10	\$61.70	\$53.30	\$48.10	\$44.60	\$42.90	\$40.30	\$37.70
<b>6" EXTENSION SPIRAL POINT TAP</b>	<b>3</b>	<b>3B</b>	<b>3</b>	<b>16307</b>		\$66.70	\$65.40	\$64.30	\$62.30	\$60.80	\$58.50	\$54.50	\$50.60
<b>8" EXTENSION HAND TAP</b>	<b>3</b>	<b>3B</b>	<b>4</b>	<b>16314</b>	<b>16315</b>	\$78.40	\$70.10	\$61.70	\$56.50	\$52.90	\$51.30	\$48.60	\$46.00
<b>10" EXTENSION HAND TAP</b>	<b>3</b>	<b>3B</b>	<b>4</b>	<b>17991</b>	<b>17992</b>	\$117.00	\$98.80	\$88.40	\$77.90	\$74.30	\$72.70	\$70.10	\$67.50
<b>12" EXTENSION HAND TAP</b>	<b>3</b>	<b>3B</b>	<b>4</b>	<b>17996</b>	<b>17997</b>	\$144.20	\$144.20	\$144.20	\$144.20	\$144.20	\$144.20	\$144.20	\$144.20



Click on Item Number for Catalog Listing

SIZE/ DESCRIPTION	GH #	CLASS OF FIT	# FLUTES	ITEM #		1 PC	2 PC	3 PC	6 PC	9 PC	12 PC	24 PC	48 PC
				PLUG	BOTTOM								
<b>5/8"-11 NC</b>				<i>See Previous Page for Recommended Hole Size</i>									
TRU-FLO FORM TAP	7	3B		19128	19129	\$57.90	\$54.00	\$51.80	\$47.50	\$43.90	\$42.30	\$40.20	\$37.00
TRU-FLO FORM TAP	10	2B		19130	19131	\$57.90	\$54.00	\$51.80	\$47.50	\$43.90	\$42.30	\$40.20	\$37.00
COST CUTTER DRILL/TAP	3	3B	4	29036		\$118.00	\$116.00	\$113.90	\$87.60	\$82.20	\$74.20	\$71.50	\$65.70
SOLID CARBIDE TAP	3	3B	4	47207	47208	\$359.90	\$333.80	\$321.30	\$312.60	\$309.60	\$307.30	\$304.60	\$303.20
TiN COAT/SP PT x 6" TAP	3	3B	3	50020		\$78.20	\$76.90	\$75.80	\$73.80	\$72.30	\$70.00	\$66.00	\$62.10
R.H. ROUND DIE 1-1/2"OD				13204		\$59.60	\$59.60	\$59.60	\$51.40	\$49.30	\$45.20	\$43.50	\$43.20
L.H. ROUND DIE 1-1/2"OD				13205		\$101.20	\$86.10	\$68.80	\$57.20	\$54.70	\$50.10	\$46.00	\$45.40
GAGE - Taperlock Style		2B		23193		\$128.50							
GAGE - Taperlock Style		3B		23194		\$128.50							
GAGE - Reversible Style		2B		24349		\$184.60							
GAGE - Reversible Style		3B		24350		\$184.60							
GAGE - Ring-Go		2A		23578		\$155.70							
GAGE - Ring-Go		3A		23579		\$155.70							
GAGE - Ring-NoGo		2A		23580		\$155.70							
GAGE - Ring-NoGo		3A		23581		\$155.70							
GAGE - STI Plug Taperlock Style		2B		24737		\$204.60							
GAGE - STI Plug Taperlock Style		3B		24738		\$204.60							
<b>5/8"-11 BSW 55° MOD WHITWORTH</b>				<i>Recommended Hole Size = .5377"</i>									
	3		4	16265	16266	\$57.90	\$57.00	\$55.50	\$51.60	\$46.30	\$42.80	\$38.90	\$35.50
<b>5/8"-12 NS</b>				<i>Recommended Hole Size based on 75% Thread = .5442"</i>									
HAND TAP	3	3B	4	16320	16321	\$50.70	\$49.90	\$48.60	\$40.50	\$37.30	\$35.60	\$33.00	\$30.40
GAGE - Taperlock Style		2B		22323		\$195.50							
GAGE - Taperlock Style		3B		22324		\$195.50							
GAGE - Ring-Go		2A		22325		\$271.30							
GAGE - Ring-Go		3A		22326		\$271.30							
GAGE - Ring-NoGo		2A		22327		\$271.30							
GAGE - Ring-NoGo		3A		22328		\$271.30							
<b>5/8"-16 NS</b>				<i>Recommended Hole Size based on 75% Thread = .5644"</i>									
HAND TAP	3	3B	4	16325	16326	\$50.70	\$49.90	\$48.60	\$40.50	\$37.30	\$35.60	\$33.00	\$30.40
GAGE - Taperlock Style		2B		22329		\$195.50							
GAGE - Taperlock Style		3B		22330		\$195.50							
GAGE - Ring-Go		2A		22331		\$271.30							
GAGE - Ring-Go		3A		22332		\$271.30							
GAGE - Ring-NoGo		2A		22333		\$271.30							
GAGE - Ring-NoGo		3A		22334		\$271.30							
<b>5/8"-18 NF</b>				<i>Recommended Hole Size based on 75% Thread = .5714" TRU-FLO at 65% Thread = .6004"</i>									
REGULAR SPIRAL FLUTE TAP	3	3B	4	16339	16340	\$75.50	\$74.00	\$68.00	\$56.70	\$41.50	\$39.80	\$38.60	\$35.80
FAST SPIRAL FLUTE TAP	3	3B	4	17727	17728	\$75.60	\$74.10	\$68.10	\$56.70	\$49.80	\$43.40	\$38.70	\$33.70
L.H. HAND TAP	3	3B	4	16330	16331	\$37.70	\$33.00	\$30.40	\$30.40	\$30.40	\$30.40	\$30.40	\$29.10
SPIRAL POINT TAP	3	3B	3	18353		\$53.90	\$53.00	\$51.80	\$43.60	\$40.40	\$38.70	\$36.10	\$33.70
SPIRAL POINT TAP	5	2B	3	17683		\$96.20	\$64.60	\$53.90	\$44.00	\$40.00	\$38.40	\$35.70	\$33.10
+.003 HAND TAP	7		4	17681	17682	\$93.50	\$61.90	\$51.20	\$41.30	\$37.30	\$35.70	\$33.00	\$30.40
HAND TAP	8		4	17904	17905	\$37.70	\$36.50	\$34.60	\$33.00	\$32.30	\$31.50	\$30.40	\$29.10
+.005 HAND TAP	11	PLATING	4	16335	16336	\$37.70	\$33.00	\$30.40	\$30.40	\$30.40	\$30.40	\$30.40	\$29.10
6" EXTENSION HAND TAP	3	3B	4	16344	16345	\$70.10	\$61.70	\$53.30	\$48.10	\$44.60	\$42.90	\$40.30	\$37.70



TAPS, DIES & GAGES

Click on Item Number for Catalog Listing

SIZE/ DESCRIPTION	GH #	CLASS OF FIT	# FLUTES	ITEM #		1 PC	2 PC	3 PC	6 PC	9 PC	12 PC	24 PC	48 PC
				PLUG	BOTTOM								
<b>5/8"-18 NF</b>				<i>See Previous Page for Recommended Hole Size</i>									
TRU-FLO FORM TAP	7	3B		19132	19133	\$57.90	\$54.00	\$51.80	\$47.50	\$43.90	\$42.30	\$40.20	\$37.00
TRU-FLO FORM TAP	10	2B		19134	19135	\$57.90	\$54.00	\$51.80	\$47.50	\$43.90	\$42.30	\$40.20	\$37.00
SOLID CARBIDE TAP	3	3B	4	47210	47211	\$359.90	\$333.80	\$321.30	\$312.60	\$309.60	\$307.30	\$304.60	\$303.20
TiN COAT/FAST SP FLT TAP	3	3B	4		50032	\$84.30	\$82.80	\$76.80	\$65.40	\$58.50	\$52.10	\$47.40	\$42.40
TiN COAT/SP PT TAP	5	2B	3	50028		\$109.40	\$77.80	\$67.00	\$57.20	\$53.10	\$51.60	\$48.90	\$46.20
R.H. ROUND DIE 1-1/2"OD				13212		\$59.60	\$59.60	\$59.60	\$51.60	\$49.30	\$45.20	\$43.50	\$43.20
L.H. ROUND DIE 1-1/2"OD				13213		\$101.20	\$86.10	\$68.80	\$57.20	\$54.70	\$50.10	\$46.00	\$45.40
GAGE - Taperlock Style		2B		23198		\$128.50							
GAGE - Taperlock Style		3B		23199		\$128.50							
GAGE - Reversible Style		2B		24354		\$184.60							
GAGE - Reversible Style		3B		24355		\$184.60							
GAGE - Ring-Go		2A		23584		\$155.70							
GAGE - Ring-Go		3A		23585		\$155.70							
GAGE - Ring-NoGo		2A		23586		\$155.70							
GAGE - Ring-NoGo		3A		23587		\$155.70							
GAGE - STI Plug Taperlock Style		2B		24742		\$204.60							
GAGE - STI Plug Taperlock Style		3B		24743		\$204.60							
<b>5/8"-20 NS</b>				<i>Recommended Hole Size based on 75% Thread = .5765"</i>									
HAND TAP	3	3B	4	16349	16350	\$50.70	\$49.90	\$48.60	\$40.50	\$37.30	\$35.60	\$33.00	\$30.40
R.H. ROUND DIE 1-1/2"OD				13214		\$101.20	\$86.10	\$68.80	\$57.20	\$54.70	\$50.10	\$46.00	\$45.40
GAGE - Taperlock Style		2B		22343		\$210.30							
GAGE - Taperlock Style		3B		22344		\$210.30							
GAGE - Ring-Go		2A		22345		\$271.30							
GAGE - Ring-Go		3A		22346		\$271.30							
GAGE - Ring-NoGo		2A		22347		\$271.30							
GAGE - Ring-NoGo		3A		22348		\$271.30							
<b>5/8"-24 NEF</b>				<i>Recommended Hole Size based on 75% Thread = .5840"</i>									
HAND TAP	3	3B	6	16354	16355	\$39.20	\$36.10	\$33.30	\$24.10	\$21.40	\$19.90	\$19.90	\$19.90
HAND TAP	5	2B	6	16359	16360	\$39.70	\$39.10	\$38.10	\$31.70	\$28.30	\$25.70	\$25.70	\$25.70
R.H. ROUND DIE 1-1/2"OD				13216		\$101.20	\$86.10	\$68.80	\$57.20	\$54.70	\$50.10	\$46.00	\$45.40
GAGE - Taperlock Style		2B		23203		\$197.00							
GAGE - Taperlock Style		3B		23204		\$197.00							
GAGE - Reversible Style		2B		24967		\$300.10							
GAGE - Reversible Style		3B		24968		\$300.10							
GAGE - Ring-Go		2A		23590		\$199.00							
GAGE - Ring-Go		3A		23591		\$199.00							
GAGE - Ring-NoGo		2A		23592		\$199.00							
GAGE - Ring-NoGo		3A		23593		\$199.00							
<b>5/8"-27 NS</b>				<i>Recommended Hole Size based on 75% Thread = .5890"</i>									
HAND TAP	3	3B	6	16364	16365	\$50.70	\$49.90	\$48.60	\$40.50	\$37.30	\$35.60	\$33.00	\$30.40
R.H. ROUND DIE 1-1/2"OD				13218		\$101.20	\$86.10	\$68.80	\$57.20	\$54.70	\$50.10	\$46.00	\$45.40
<b>5/8"-28 NS</b>				<i>Recommended Hole Size based on 75% Thread = .5903"</i>									
HAND TAP	3	3B	6	16369	16370	\$50.70	\$49.90	\$48.60	\$40.50	\$37.30	\$35.60	\$33.00	\$30.40
R.H. ROUND DIE 1-1/2"OD				13220		\$101.20	\$86.10	\$68.80	\$57.20	\$54.70	\$50.10	\$46.00	\$45.40
GAGE - Taperlock Style		2B		22355		\$240.20							





Click on Item Number for Catalog Listing

SIZE/ DESCRIPTION	GH #	CLASS OF FIT	# FLUTES	ITEM #		1 PC	2 PC	3 PC	6 PC	9 PC	12 PC	24 PC	48 PC
				PLUG	BOTTOM								
<b>5/8"-28 NS</b>													
<i>See Previous Page for Recommended Hole Size</i>													
GAGE - Taperlock Style		3B		22356		\$240.20							
GAGE - Ring-Go		2A		22357		\$240.20							
GAGE - Ring-Go		3A		22358		\$339.20							
GAGE - Ring-NoGo		2A		22359		\$339.20							
GAGE - Ring-NoGo		3A		22360		\$339.20							
<b>5/8"-32 NS</b>													
<i>\$339.20</i>													
HAND TAP	3	3B	6	16374	16375	\$50.70	\$49.90	\$48.60	\$40.50	\$37.30	\$35.60	\$33.00	\$30.40
R.H. ROUND DIE 1-1/2"OD				13222		\$101.20	\$86.10	\$68.80	\$57.20	\$54.70	\$50.10	\$46.00	\$45.40
GAGE - Taperlock Style		2B		22361		\$240.20							
GAGE - Taperlock Style		3B		22362		\$240.20							
GAGE - Ring-Go		2A		22363		\$339.20							
GAGE - Ring-Go		3A		22364		\$339.20							
GAGE - Ring-NoGo		2A		22365		\$339.20							
GAGE - Ring-NoGo		3A		22366		\$339.20							
<b>41/64"-11 NS</b>													
<i>Recommended Hole Size based on 75% Thread = .5521"</i>													
HAND TAP	4	3B	4	16379	16380	\$59.90	\$59.00	\$57.50	\$47.90	\$43.90	\$43.10	\$41.80	\$36.60
<b>11/16"-11 NS</b>													
<i>Recommended Hole Size based on 75% Thread = .5990"</i>													
L.H. HAND TAP	3	3B	4	16384	16385	\$53.90	\$53.00	\$51.80	\$43.60	\$37.40	\$35.60	\$33.70	\$32.20
<b>11/16"-16 NS</b>													
<i>Recommended Hole Size based on 75% Thread = .6269"</i>													
L.H. HAND TAP	3	3B	4	16389	16390	\$53.90	\$53.00	\$51.80	\$43.60	\$37.40	\$35.60	\$33.70	\$32.20
L.H. ROUND DIE 2"OD				13229		\$124.80	\$104.70	\$98.30	\$92.80	\$88.60	\$81.10	\$71.60	\$71.00
GAGE - Taperlock Style		2B		22367		\$210.30							
GAGE - Taperlock Style		3B		22368		\$210.30							
GAGE - Ring-Go		2A		22369		\$271.30							
GAGE - Ring-Go		3A		22370		\$271.30							
GAGE - Ring-NoGo		2A		22371		\$271.30							
GAGE - Ring-NoGo		3A		22372		\$271.30							
<b>11/16"-18 NS</b>													
<i>Recommended Hole Size based on 75% Thread = .6339"</i>													
L.H. HAND TAP	3	3B	4	17576	17577	\$57.50	\$56.60	\$55.10	\$46.00	\$34.40	\$32.80	\$31.60	\$30.00
HAND TAP	3	3B	4	16394	16395	\$53.90	\$53.00	\$51.80	\$43.60	\$37.40	\$35.60	\$33.70	\$32.20
R.H. ROUND DIE 2"OD				13230		\$124.80	\$104.70	\$98.30	\$92.80	\$88.60	\$81.10	\$71.60	\$71.00
<b>11/16"-20 NS</b>													
<i>Recommended Hole Size based on 75% Thread = .6390"</i>													
HAND TAP	3	3B	6	16399	16400	\$53.90	\$53.00	\$51.80	\$43.60	\$37.40	\$35.60	\$33.70	\$32.20
R.H. ROUND DIE 2"OD				13232		\$124.80	\$104.70	\$98.30	\$92.80	\$88.60	\$81.10	\$71.60	\$71.00
GAGE - Taperlock Style		2B		22373		\$210.30							
GAGE - Taperlock Style		3B		22374		\$210.30							
GAGE - Ring-Go		2A		22375		\$271.30							
GAGE - Ring-Go		3A		22376		\$271.30							
GAGE - Ring-NoGo		2A		22377		\$271.30							
GAGE - Ring-NoGo		3A		22378		\$271.30							
<b>11/16"-24 NEF</b>													
<i>Recommended Hole Size based on 75% Thread = .6465"</i>													
HAND TAP	3	3B	6	16404	16405	\$39.30	\$34.70	\$30.70	\$27.50	\$27.50	\$27.50	\$27.50	\$27.10
HAND TAP	5	2B	6	16409	16410	\$44.90	\$44.30	\$43.10	\$36.00	\$32.40	\$30.40	\$27.50	\$27.10
R.H. ROUND DIE 2"OD				13234		\$124.80	\$104.70	\$98.30	\$92.80	\$88.60	\$81.10	\$71.60	\$71.00
GAGE - Taperlock Style		2B		23208		\$200.70							

TAPS, DIES & GAGES

Click on Item Number for Catalog Listing

SIZE/ DESCRIPTION	GH #	CLASS OF FIT	# FLUTES	ITEM #		1 PC	2 PC	3 PC	6 PC	9 PC	12 PC	24 PC	48 PC
				PLUG	BOTTOM								
<b>11/16"-24 NEF</b>						<i>See Previous Page for Recommended Hole Size</i>							
GAGE - Taperlock Style		3B		23209		\$200.70							
GAGE - Reversible Style		2B		24972		\$300.10							
GAGE - Reversible Style		3B		24973		\$300.10							
GAGE - Ring-Go		2A		23596		\$229.70							
GAGE - Ring-Go		3A		23597		\$229.70							
GAGE - Ring-NoGo		2A		23598		\$229.70							
GAGE - Ring-NoGo		3A		23599		\$229.70							
<b>11/16"-28 NS</b>						<i>Recommended Hole Size based on 75% Thread = .6528"</i>							
<b>HAND TAP</b>	<b>3</b>	<b>3B</b>	<b>6</b>	<b>16419</b>	<b>16420</b>	\$57.50	\$56.70	\$55.20	\$46.00	\$37.40	\$34.30	\$32.20	\$28.80
GAGE - Taperlock Style		2B		22379		\$255.00							
GAGE - Taperlock Style		3B		22380		\$255.00							
GAGE - Ring-Go		2A		22381		\$339.20							
GAGE - Ring-Go		3A		22382		\$339.20							
GAGE - Ring-NoGo		2A		22383		\$339.20							
GAGE - Ring-NoGo		3A		22384		\$339.20							
<b>11/16"-32 NS</b>						<i>Recommended Hole Size based on 75% Thread = .6572"</i>							
<b>HAND TAP</b>	<b>3</b>	<b>3B</b>	<b>6</b>	<b>16424</b>	<b>16425</b>	\$57.50	\$56.70	\$55.20	\$46.00	\$37.40	\$34.30	\$32.20	\$28.80
R.H. ROUND DIE 2"OD				13238		\$124.80	\$104.70	\$98.30	\$92.80	\$88.60	\$81.10	\$71.60	\$71.00
GAGE - Taperlock Style		2B		22385		\$255.10							
GAGE - Taperlock Style		3B		22386		\$255.10							
GAGE - Ring-Go		2A		22387		\$339.20							
GAGE - Ring-Go		3A		22388		\$339.20							
GAGE - Ring-NoGo		2A		22389		\$339.20							
GAGE - Ring-NoGo		3A		22390		\$339.20							
<b>3/4"-5 ACME</b>						<i>Recommended Hole Size = .550"</i>							
<b>HAND TAP</b>		<b>2G</b>	<b>4</b>	<b>18102</b>	<b>18103</b>	\$85.60	\$84.40	\$82.20	\$68.50	\$59.00	\$55.00	\$47.80	\$44.40
<b>3/4"-6 ACME</b>						<i>Recommended Hole Size = .5833"</i>							
<b>HAND TAP</b>		<b>2G</b>	<b>4</b>	<b>16432</b>		\$83.20	\$82.10	\$79.90	\$66.60	\$61.70	\$57.50	\$50.00	\$46.40
<b>L.H. HAND TAP</b>		<b>2G</b>	<b>4</b>	<b>16436</b>		\$83.20	\$82.10	\$79.90	\$66.60	\$61.70	\$57.50	\$50.00	\$46.40
<b>TANDEM TAP</b>		<b>2G</b>	<b>4</b>	<b>16438</b>		\$178.80	\$143.10	\$115.30	\$106.60	\$103.50	\$100.20	\$100.20	\$100.20
<b>L.H. TANDEM TAP</b>		<b>2G</b>	<b>4</b>	<b>16439</b>		\$178.80	\$143.10	\$115.30	\$106.60	\$103.50	\$100.20	\$100.20	\$100.20
<b>3/4"-8 ACME</b>						<i>Recommended Hole Size = .625"</i>							
<b>HAND TAP</b>		<b>2G</b>	<b>4</b>	<b>16442</b>		\$92.30	\$91.10	\$88.70	\$73.90	\$68.90	\$62.20	\$56.10	\$48.70
<b>TANDEM TAP</b>		<b>2G</b>	<b>4</b>	<b>16444</b>		\$189.00	\$151.20	\$146.60	\$136.40	\$129.40	\$105.90	\$102.70	\$99.30
<b>L.H. TANDEM TAP</b>		<b>2G</b>	<b>4</b>	<b>16445</b>		\$189.00	\$151.20	\$146.60	\$136.40	\$129.40	\$105.90	\$102.70	\$99.30
<b>3/4"-10 NC</b>						<i>Recommended Hole Size based on 75% Thread = .6526" TRU-FLO at 65% Thread = .7058"</i>							
<b>REGULAR SPIRAL FLUTE TAP</b>	<b>3</b>	<b>3B</b>	<b>4</b>	<b>16463</b>	<b>16464</b>	\$91.70	\$89.80	\$82.50	\$68.70	\$50.40	\$41.30	\$38.50	\$36.60
<b>L.H. HAND TAP</b>	<b>3</b>	<b>3B</b>	<b>4</b>	<b>16449</b>	<b>16450</b>	\$54.90	\$54.00	\$52.70	\$44.40	\$41.70	\$39.70	\$37.30	\$33.80
<b>+.005 HAND TAP</b>	<b>11</b>	<b>PLATING</b>	<b>4</b>	<b>16454</b>	<b>16455</b>	\$37.30	\$37.30	\$36.40	\$31.40	\$30.10	\$28.40	\$27.00	\$26.60
<b>+.005 SPIRAL POINT TAP</b>	<b>11</b>	<b>PLATING</b>	<b>3</b>	<b>16452</b>		\$42.10	\$42.10	\$40.90	\$36.00	\$34.70	\$33.00	\$31.60	\$31.40
<b>+.010 HAND TAP</b>	<b>21</b>		<b>4</b>	<b>16459</b>	<b>16460</b>	\$71.40	\$70.30	\$68.50	\$57.10	\$42.90	\$35.80	\$34.30	\$32.80
<b>6" EXTENSION HAND TAP</b>	<b>3</b>	<b>3B</b>	<b>4</b>	<b>16478</b>	<b>16479</b>	\$104.10	\$94.70	\$84.30	\$73.80	\$57.90	\$52.30	\$46.20	\$40.80
<b>6" EXTENSION SP PT TAP</b>	<b>3</b>	<b>3B</b>	<b>3</b>	<b>17632</b>		\$113.00	\$108.60	\$103.70	\$78.70	\$74.00	\$71.50	\$70.00	\$67.50
<b>8" EXTENSION HAND TAP</b>	<b>3</b>	<b>3B</b>	<b>4</b>	<b>16483</b>	<b>16484</b>	\$119.40	\$107.10	\$96.80	\$75.40	\$69.90	\$64.80	\$58.20	\$51.40



Click on Item Number for Catalog Listing

SIZE/ DESCRIPTION	GH #	CLASS OF FIT	# FLUTES	ITEM #		1 PC	2 PC	3 PC	6 PC	9 PC	12 PC	24 PC	48 PC
				PLUG	BOTTOM								
<b>3/4"-10 NC</b>				<i>See Previous Page for Recommended Hole Size</i>									
10" EXTENSION HAND TAP	3	3B	4	16488	16489	\$131.10	\$118.80	\$107.50	\$84.80	\$79.80	\$74.70	\$67.90	\$62.00
TRU-FLO FORM TAP	7	3B		19136	19137	\$63.40	\$59.40	\$57.20	\$52.90	\$49.40	\$47.70	\$45.60	\$42.50
TRU-FLO FORM TAP	10	2B		19138	19139	\$63.40	\$59.40	\$57.20	\$52.90	\$49.40	\$47.70	\$45.60	\$42.50
SOLID CARBIDE TAP	3	3B	4	47213	47214	\$386.00	\$359.80	\$347.30	\$338.50	\$336.00	\$334.20	\$331.50	\$330.50
SOLID CARBIDE TAP	5	3B	4	47228	47229	\$386.00	\$359.80	\$347.30	\$338.50	\$336.00	\$334.20	\$331.50	\$330.50
TiN COAT/SPPTx6" TAP	3	3B	3	50027		\$126.20	\$121.80	\$116.90	\$91.90	\$87.20	\$84.70	\$83.10	\$80.60
R.H. ROUND DIE 2"OD				13240		\$96.80	\$96.80	\$96.80	\$78.50	\$75.30	\$69.00	\$66.10	\$65.80
L.H. ROUND DIE 2"OD				13241		\$124.80	\$104.70	\$98.30	\$92.80	\$88.60	\$81.10	\$71.60	\$71.00
GAGE - Taperlock Style		2B		23213		\$146.60							
GAGE - Taperlock Style		3B		23214		\$146.60							
GAGE - Reversible Style		2B		24359		\$202.60							
GAGE - Reversible Style		3B		24360		\$202.60							
GAGE - Ring-Go		2A		23602		\$202.60							
GAGE - Ring-Go		3A		23603		\$202.60							
GAGE - Ring-NoGo		2A		23604		\$202.60							
GAGE - Ring-NoGo		3A		23605		\$202.60							
GAGE - STI Plug Taperlock Style		2B		24747		\$215.30							
GAGE - STI Plug Taperlock Style		3B		24748		\$215.30							
<b>3/4"-10 ACME</b>				<i>Recommended Hole Size = .6500"</i>									
HAND TAP		2G	4	16493		\$110.70	\$98.80	\$90.10	\$71.90	\$65.70	\$53.40	\$51.00	\$46.40
<b>3/4"-11.5 NH</b>				<i>Recommended Hole Size = .9688"</i>									
GARDEN HOSE TAP			6	16497	16498	\$111.00	\$106.50	\$97.20	\$88.90	\$66.60	\$63.50	\$62.10	\$60.80
<b>3/4"-12 NS</b>				<i>Recommended Hole Size based on 75% Thread = .6692"</i>									
HAND TAP	4	3B	4	16502	16503	\$63.70	\$61.90	\$61.00	\$47.20	\$38.30	\$37.00	\$34.60	\$33.90
R.H. ROUND DIE 2"OD				13242		\$124.80	\$104.70	\$98.30	\$92.80	\$88.60	\$81.10	\$71.60	\$71.00
GAGE - Taperlock Style		2B		22400		\$210.30							
GAGE - Taperlock Style		3B		22401		\$210.30							
GAGE - Ring-Go		2A		22402		\$271.30							
GAGE - Ring-Go		3A		22403		\$271.30							
GAGE - Ring-NoGo		2A		22404		\$271.30							
GAGE - Ring-NoGo		3A		22405		\$271.30							
<b>3/4"-14 PIPE TAP NPSI NPSF NPT/F NPS</b>				<i>Recommended Hole Size: NPT = .9063" / NPTF = .9219" NPSI = .9283"</i>									
NPT/F REG. SPR FLT TAPER TAP			5	16505		\$120.70	\$89.40	\$78.90	\$68.50	\$64.90	\$63.30	\$60.70	\$58.00
NPT/F LEFT HAND TAPER TAP			5	16508		\$99.10	\$97.80	\$91.20	\$77.00	\$73.00	\$61.70	\$60.80	\$60.10
NPT/F 6" EXTENSION TAPER TAP			5	16511		\$106.50	\$106.50	\$106.50	\$103.50	\$98.10	\$93.70	\$87.40	\$85.80
NPT/F 6" EXTENSION INT TAPER TAP			5	16514		\$126.50	\$126.50	\$126.50	\$122.80	\$116.10	\$110.60	\$102.60	\$97.90
NPT/F 8" EXTENSION TAPER TAP			5	16517		\$133.40	\$130.50	\$126.60	\$116.30	\$112.80	\$107.80	\$104.20	\$102.60
NPT/F 10" EXTENSION TAPER TAP			5	18105		\$162.40	\$152.00	\$141.50	\$131.10	\$127.50	\$125.90	\$123.30	\$120.60
NPSI STRAIGHT TAP			5	16523		\$111.70	\$110.00	\$107.20	\$84.10	\$75.80	\$65.50	\$60.80	\$55.40
NPT/F CARB-I-SERT TAP			4	41810		\$628.90	\$620.60	\$489.80	\$445.40	\$436.90	\$421.70	\$397.80	\$391.30
NPT/F COST CUTTER DRILL/TAP			4	29045		\$227.30	\$217.10	\$212.80	\$206.90	\$193.10	\$178.40	\$172.40	\$168.80
NPT R.H. ROUND DIE 2"OD				13258		\$124.80	\$104.70	\$98.30	\$92.80	\$88.60	\$81.10	\$71.60	\$71.00

TAPS, DIES & GAGES

Click on Item Number for Catalog Listing

SIZE/DESCRIPTION	GH #	CLASS OF FIT	# FLUTES	ITEM #		1 PC	2 PC	3 PC	6 PC	9 PC	12 PC	24 PC	48 PC
				PLUG	BOTTOM								
<b>3/4"-14 PIPE TAP</b>				<i>See Previous Page for Recommended Hole Size</i>									
<b>NPSI NPSF NPT/F NPS</b>													
NPS R.H. ROUND DIE 2"OD				13260		\$247.30	\$208.50	\$131.10	\$114.10				
GAGE L1 NPT PLG w/handle				24383		\$127.40							
GAGE L1 NPT RING				24381		\$225.10							
GAGE L1 NPTF PLG w/handle				24458		\$188.50							
GAGE L3 NPTF PLG w/handle				24460		\$188.50							
GAGE NPTF 6 step Plain Plug w/handle				24544		\$221.30							
GAGE L1 NPTF RING				24506		\$236.30							
GAGE L2 NPTF RING				24508		\$358.00							
GAGE NPTF 6 step Plain Ring				24578		\$383.60							
<b>3/4"-14 55° WHITWORTH PIPE</b>				<i>Recommended Hole Size: BSPT = .9219" / BSPP = .9531"</i>									
BSPT TAPER - MODIFIED TAP			5	16526	16527	\$69.40	\$69.40	\$69.40	\$62.60	\$62.60	\$62.60	\$62.60	\$62.60
BSPP PARALLEL - MODIFIED TAP			5	16529	16530	\$69.40	\$69.40	\$69.40	\$62.60	\$62.60	\$62.60	\$62.60	\$62.60
BSPT TAPER - FULL FORM TAP			5	17936		\$139.80	\$131.30	\$125.10	\$119.30	\$110.80	\$109.10	\$106.50	\$103.90
BSPP PARALLEL - FULL FORM TAP			5	17927		\$139.80	\$131.30	\$125.10	\$119.30	\$110.80	\$109.10	\$106.50	\$103.90
BSPT FULL FORM DIE 2 "OD				13700		\$418.90							
BSPP FULL FORM DIE 2 "OD				13701		\$225.50							
GAGE BSPT-Mod. w/handle				27014		\$328.60							
GAGE BSPP-Mod. DBL END w/handle				27053		\$393.50							
<b>3/4"-16 NF</b>				<i>Recommended Hole Size based on 75% Thread = .6894" TRU-FLO at 65% Thread = .7224"</i>									
REGULAR SPIRAL FLUTE TAP	3	3B	4	16543	16544	\$91.60	\$89.80	\$82.40	\$68.70	\$50.40	\$41.20	\$38.60	\$36.00
L.H. HAND TAP	3	3B	4	16534	16535	\$54.90	\$54.00	\$52.70	\$44.40	\$41.70	\$39.70	\$37.30	\$33.80
SPIRAL POINT TAP	3	3B	3	18374		\$82.80	\$69.50	\$61.60	\$51.20	\$47.60	\$45.90	\$43.30	\$40.70
SPIRAL POINT TAP	5	2B	3	17692		\$78.60	\$70.90	\$61.60	\$51.00	\$46.60	\$41.00	\$39.20	\$36.20
L.H. HAND TAP	5	2B	4	17788	17789	\$64.10	\$58.80	\$53.70	\$43.20	\$37.60	\$35.70	\$35.40	\$32.80
+.003 HAND TAP	7		4	17637	17638	\$53.10	\$51.40	\$49.10	\$42.70	\$41.20	\$39.60	\$36.90	\$34.30
HAND TAP	8		4	17745	17746	\$56.30	\$53.60	\$51.40	\$46.10	\$42.60	\$40.90	\$38.30	\$35.70
+.005 HAND TAP	11	PLATING	4	16539	16540	\$37.30	\$37.30	\$36.40	\$31.40	\$30.10	\$28.40	\$27.00	\$26.60
TRU-FLO FORM TAP	7	3B		19140	19141	\$63.40	\$59.40	\$57.20	\$52.90	\$49.40	\$47.70	\$45.60	\$42.50
TRU-FLO FORM TAP	10	2B		19142	19143	\$63.40	\$59.40	\$57.20	\$52.90	\$49.40	\$47.70	\$45.60	\$42.50
SOLID CARBIDE TAP	3	3B	4	47216	47217	\$386.00	\$359.80	\$347.30	\$338.50	\$336.00	\$334.20	\$331.50	\$330.50
SOLID CARBIDE TAP	5	3B	4	47231	47232	\$386.00	\$359.80	\$347.30	\$338.50	\$336.00	\$334.20	\$331.50	\$330.50
TiN COAT/HAND TAP	8		4	50033		\$66.00	\$63.30	\$61.10	\$55.90	\$52.30	\$50.60	\$48.00	\$45.40
R.H. ROUND DIE 2"OD				13246		\$96.80	\$96.80	\$96.80	\$78.50	\$75.30	\$69.00	\$66.10	\$65.80
L.H. ROUND DIE 2"OD				13247		\$124.80	\$104.70	\$98.30	\$92.80	\$88.60	\$81.10	\$71.60	\$71.00
GAGE - Taperlock Style		2B		23218		\$146.60							
GAGE - Taperlock Style		3B		23219		\$146.60							
GAGE - Reversible Style		2B		24364		\$202.60							
GAGE - Reversible Style		3B		24365		\$202.60							
GAGE - Ring-Go		2A		23608		\$202.60							
GAGE - Ring-Go		3A		23609		\$202.60							
GAGE - Ring-NoGo		2A		23610		\$202.60							
GAGE - Ring-NoGo		3A		23611		\$202.60							



Click on Item Number  
for Catalog Listing

SIZE/ DESCRIPTION	GH #	CLASS OF FIT	# FLUTES	ITEM #		1 PC	2 PC	3 PC	6 PC	9 PC	12 PC	24 PC	48 PC
				PLUG	BOTTOM								
<b>3/4"-16 NF</b>				<i>See Previous Page for Recommended Hole Size</i>									
GAGE - STI Plug Taperlock Style		2B		24752		\$215.30							
GAGE - STI Plug Taperlock Style		3B		24753		\$215.30							
<b>3/4"-18 NS</b>				<i>Recommended Hole Size based on 75% Thread = .6964"</i>									
<b>HAND TAP</b>	<b>3</b>	<b>3B</b>	<b>4</b>	<b>16548</b>	<b>16549</b>	<b>\$63.70</b>	<b>\$61.90</b>	<b>\$61.00</b>	<b>\$50.90</b>	<b>\$39.70</b>	<b>\$37.00</b>	<b>\$34.60</b>	<b>\$31.50</b>
R.H. ROUND DIE 2"OD				13248		\$124.80	\$104.70	\$98.30	\$92.80	\$88.60	\$81.10	\$71.60	\$71.00
<b>3/4"-20 NEF</b>				<i>Recommended Hole Size based on 75% Thread = .7015"</i>									
L.H. HAND TAP	3	3B	6	17663	17664	\$53.10	\$51.40	\$49.10	\$42.70	\$41.20	\$39.60	\$36.90	\$34.30
HAND TAP	3	3B	6	16553	16554	\$34.50	\$34.50	\$34.50	\$29.10	\$29.10	\$29.10	\$29.10	\$29.10
HAND TAP	5	2B	6	16558	16559	\$51.20	\$50.40	\$39.20	\$30.00	\$29.10	\$29.10	\$29.10	\$29.10
R.H. ROUND DIE 2"OD				13250		\$124.80	\$104.70	\$98.30	\$92.80	\$88.60	\$81.10	\$71.60	\$71.00
GAGE - Taperlock Style		2B		23223		\$208.00							
GAGE - Taperlock Style		3B		23224		\$208.00							
GAGE - Reversible Style		2B		24977		\$310.90							
GAGE - Reversible Style		3B		24978		\$310.90							
GAGE - Ring-Go		2A		23614		\$247.70							
GAGE - Ring-Go		3A		23615		\$247.70							
GAGE - Ring-NoGo		2A		23616		\$247.70							
GAGE - Ring-NoGo		3A		23617		\$247.70							
<b>3/4"-24 NS</b>				<i>Recommended Hole Size based on 75% Thread = .709"</i>									
HAND TAP	3	3B	6	16563	16564	\$63.70	\$61.90	\$61.00	\$45.40	\$39.80	\$35.60	\$33.40	\$31.50
R.H. ROUND DIE 2"OD				13252		\$124.80	\$104.70	\$98.30	\$92.80	\$88.60	\$81.10	\$71.60	\$71.00
<b>3/4"-27 NS</b>				<i>Recommended Hole Size based on 75% Thread = .714"</i>									
HAND TAP	3	3B	6	16568	16569	\$63.70	\$61.90	\$61.00	\$45.40	\$39.80	\$35.60	\$33.40	\$31.50
R.H. ROUND DIE 2"OD				13254		\$124.80	\$104.70	\$98.30	\$92.80	\$88.60	\$81.10	\$71.60	\$71.00
<b>3/4"-32 NS</b>				<i>Recommended Hole Size based on 75% Thread = .7197"</i>									
HAND TAP	3	3B	6	16573	16574	\$63.70	\$61.90	\$61.00	\$45.40	\$39.80	\$35.60	\$33.40	\$31.50
R.H. ROUND DIE 2"OD				13256		\$124.80	\$104.70	\$98.30	\$92.80	\$88.60	\$81.10	\$71.60	\$71.00
GAGE - Taperlock Style		2B		22414		\$255.10							
GAGE - Taperlock Style		3B		22415		\$255.10							
GAGE - Ring-Go		2A		22416		\$339.20							
GAGE - Ring-Go		3A		22417		\$339.20							
GAGE - Ring-NoGo		2A		22418		\$339.20							
GAGE - Ring-NoGo		3A		22419		\$339.20							
<b>3/4"-40 NS</b>				<i>Recommended Hole Size based on 75% Thread = .7258"</i>									
HAND TAP	3	3B	6	16578	16579	\$70.90	\$69.90	\$68.10	\$56.70	\$42.60	\$35.60	\$34.10	\$31.50
<b>49/64"-10 NS</b>				<i>Recommended Hole Size based on 75% Thread = .6682"</i>									
HAND TAP	4	3B	4	16583	16584	\$94.00	\$82.70	\$79.90	\$65.90	\$46.90	\$43.10	\$40.50	\$37.90
<b>.800"-36 AMO MOD. WHITWORTH</b>				<i>Recommended Hole Size = .7644"</i>									
HAND TAP	2		6	16592	16593	\$79.10	\$77.80	\$75.90	\$64.00	\$51.30	\$45.40	\$40.40	\$39.80
<b>13/16"-10 NS</b>				<i>Recommended Hole Size based on 75% Thread = .7151"</i>									
HAND TAP	4	3B	4	16597	16598	\$70.00	\$69.00	\$67.10	\$56.00	\$44.00	\$40.60	\$38.90	\$37.00
<b>13/16"-12 NS</b>				<i>Recommended Hole Size based on 75% Thread = .7317"</i>									
HAND TAP	4	3B	4	16602	16603	\$70.00	\$69.00	\$67.10	\$56.00	\$44.00	\$40.60	\$38.90	\$37.00
GAGE - Taperlock Style		2B		22420		\$211.80							

TAPS, DIES & GAGES

Click on Item Number for Catalog Listing

SIZE/ DESCRIPTION	GH #	CLASS OF FIT	# FLUTES	ITEM #		1 PC	2 PC	3 PC	6 PC	9 PC	12 PC	24 PC	48 PC
				PLUG	BOTTOM								
<b>13/16"-12 NS</b>						<i>See Previous Page for Recommended Hole Size</i>							
GAGE - Taperlock Style		3B		22421		\$211.80							
GAGE - Ring-Go		2A		22422		\$287.60							
GAGE - Ring-Go		3A		22423		\$287.60							
GAGE - Ring-NoGo		2A		22424		\$287.60							
GAGE - Ring-NoGo		3A		22425		\$287.60							
<b>13/16"-16 NS</b>						<i>Recommended Hole Size based on 75% Thread = .7519"</i>							
HAND TAP	3	3B	4	16607	16608	\$70.00	\$69.00	\$67.10	\$56.00	\$44.00	\$40.60	\$38.90	\$37.00
R.H. ROUND DIE 2"OD				13264		\$132.50	\$113.30	\$106.10	\$92.80	\$88.60	\$81.10	\$71.60	\$71.00
GAGE - Taperlock Style		2B		22426		\$225.20							
GAGE - Taperlock Style		3B		22427		\$225.20							
GAGE - Ring-Go		2A		22428		\$287.60							
GAGE - Ring-Go		3A		22429		\$287.60							
GAGE - Ring-NoGo		2A		22430		\$287.60							
GAGE - Ring-NoGo		3A		22431		\$287.60							
<b>13/16"-18 NS</b>						<i>Recommended Hole Size based on 75% Thread = .7519"</i>							
HAND TAP	3	3B	4	16612	16613	\$70.00	\$69.00	\$67.10	\$56.00	\$44.00	\$40.60	\$38.90	\$37.00
R.H. ROUND DIE 2"OD				13266		\$132.50	\$113.30	\$106.10	\$92.80	\$88.60	\$81.10	\$71.60	\$71.00
<b>13/16"-20 NEF</b>						<i>Recommended Hole Size based on 75% Thread = .7640"</i>							
HAND TAP	3	3B	6	16617	16618	\$49.90	\$46.80	\$43.30	\$35.10	\$35.10	\$35.10	\$35.10	\$35.10
HAND TAP	5	2B	6	16622	16623	\$59.90	\$59.00	\$57.50	\$47.90	\$38.00	\$35.10	\$35.10	\$35.10
R.H. ROUND DIE 2"OD				13268		\$132.50	\$113.30	\$106.10	\$92.80	\$88.60	\$81.10	\$71.60	\$71.00
GAGE - Taperlock Style		2B		23228		\$237.00							
GAGE - Taperlock Style		3B		23229		\$237.00							
GAGE - Ring-Go		2A		23620		\$251.30							
GAGE - Ring-Go		3A		23621		\$251.30							
GAGE - Ring-NoGo		2A		23622		\$251.30							
GAGE - Ring-NoGo		3A		23623		\$251.30							
<b>13/16"-24 NS</b>						<i>Recommended Hole Size based on 75% Thread = .7715"</i>							
HAND TAP	3	3B	6	16627	16628	\$70.00	\$69.00	\$67.10	\$56.00	\$44.00	\$40.60	\$38.90	\$37.00
R.H. ROUND DIE 2"OD				13270		\$132.50	\$113.30	\$106.10	\$92.80	\$88.60	\$81.10	\$71.60	\$71.00
<b>7/8"-6 ACME</b>						<i>Recommended Hole Size based on 75% Thread = .7083"</i>							
HAND TAP		2G	4	16631		\$90.20	\$88.90	\$86.70	\$77.00	\$75.50	\$71.90	\$69.90	\$69.40
L.H. HAND TAP		2G	4	16635		\$90.20	\$88.90	\$86.70	\$77.00	\$75.50	\$71.90	\$69.90	\$69.40
TANDEM TAP		2G	4	16637		\$207.70	\$166.20	\$116.40	\$105.50	\$105.50	\$105.50	\$105.50	\$105.50
L.H. TANDEM TAP		2G	4	16638		\$207.70	\$166.20	\$116.40	\$105.50	\$105.50	\$105.50	\$105.50	\$105.50
<b>7/8"-9 NC</b>						<i>Recommended Hole Size based on 75% Thread = .7667"</i>							
REGULAR SPIRAL FLUTE TAP	4	3B	4	16656	16657	\$110.60	\$108.30	\$99.50	\$82.90	\$60.80	\$49.90	\$47.30	\$44.70
L.H. HAND TAP	4	3B	4	16642	16643	\$62.20	\$62.20	\$62.20	\$58.80	\$52.90	\$48.60	\$47.00	\$40.90
SPIRAL POINT TAP	4	3B	3	16645		\$95.40	\$93.50	\$85.80	\$71.40	\$64.00	\$57.60	\$52.10	\$47.30
+.005 HAND TAP	11	PLATING	4	16652	16653	\$53.40	\$49.60	\$47.70	\$43.00	\$42.20	\$39.70	\$39.20	\$39.10
8" EXTENSION HAND TAP	4	3B	4	17700	17701	\$121.50	\$116.60	\$106.10	\$95.70	\$92.10	\$90.40	\$87.80	\$85.20
CARB-I-SERT TAP	4	3B	4	41558	41559	\$416.60	\$401.40	\$394.40	\$374.40	\$372.20	\$367.20	\$363.10	\$357.90
TiN COAT x 8" TAP	4	3B	4	50030		\$143.80	\$138.90	\$128.50	\$118.00	\$114.50	\$112.80	\$110.20	\$107.60
R.H. ROUND DIE 2"OD				13272		\$96.80	\$96.80	\$96.80	\$78.50	\$75.30	\$69.00	\$66.10	\$65.80
L.H. ROUND DIE 2"OD				13273		\$132.50	\$113.30	\$106.10	\$92.80	\$88.60	\$81.10	\$71.60	\$71.00





Click on Item Number  
for Catalog Listing

SIZE/ DESCRIPTION	GH #	CLASS OF FIT	# FLUTES	ITEM #		1 PC	2 PC	3 PC	6 PC	9 PC	12 PC	24 PC	48 PC
				PLUG	BOTTOM								
<b>7/8"-9 NC</b>													
<i>See Previous Page for Recommended Hole Size</i>													
GAGE - Taperlock Style		2B		23233		\$155.70							
GAGE - Taperlock Style		3B		23234		\$155.70							
GAGE - Ring-Go		2A		23626		\$209.90							
GAGE - Ring-Go		3A		23627		\$209.90							
GAGE - Ring-NoGo		2A		23628		\$209.90							
GAGE - Ring-NoGo		3A		23629		\$209.90							
<b>7/8"-10 NS</b>													
<i>Recommended Hole Size based on 75% Thread = .7776"</i>													
HAND TAP	4	3B	4	16661	16662	\$81.10	\$79.90	\$77.90	\$64.90	\$52.90	\$46.10	\$43.50	\$40.90
<b>7/8"-12 NS</b>													
<i>Recommended Hole Size based on 75% Thread = .7942"</i>													
HAND TAP	4	3B	4	16666	16667	\$81.10	\$79.90	\$77.90	\$64.90	\$52.90	\$46.10	\$43.50	\$40.90
R.H. ROUND DIE 2"OD				13274		\$132.50	\$113.30	\$106.10	\$92.80	\$88.60	\$81.10	\$71.60	\$71.00
GAGE - Taperlock Style		2B		22438		\$211.80							
GAGE - Taperlock Style		3B		22439		\$211.80							
GAGE - Ring-Go		2A		22440		\$287.60							
GAGE - Ring-Go		3A		22441		\$287.60							
GAGE - Ring-NoGo		2A		22442		\$287.60							
GAGE - Ring-NoGo		3A		22443		\$287.60							
<b>7/8"-14 NF</b>													
<i>Recommended Hole Size based on 75% Thread = .8056"</i>													
L.H. HAND TAP	4	3B	4	16671	16672	\$62.20	\$62.20	\$62.20	\$58.80	\$52.90	\$48.60	\$47.00	\$40.90
SPIRAL POINT TAP	4	3B	3	17656		\$96.40	\$94.40	\$86.70	\$73.80	\$64.00	\$57.60	\$52.10	\$47.30
HAND TAP	5		4	17749	17750	\$72.30	\$69.30	\$65.20	\$54.70	\$51.20	\$49.50	\$46.90	\$44.30
HAND TAP	6	2B	4	17686	17687	\$124.00	\$92.60	\$80.40	\$72.10	\$67.00	\$64.60	\$60.10	\$57.80
+ .005 HAND TAP	11	PLATING	4	16676	16677	\$53.40	\$49.60	\$47.70	\$43.00	\$42.20	\$39.70	\$39.20	\$39.10
CARB-I-SERT TAP	4	3B	4	41561	41562	\$416.60	\$401.40	\$394.40	\$374.40	\$372.20	\$367.20	\$363.10	\$357.90
R.H. ROUND DIE 2"OD				13276		\$96.80	\$96.80	\$96.80	\$78.50	\$75.30	\$69.00	\$66.10	\$65.80
L.H. ROUND DIE 2"OD				13277		\$132.50	\$113.30	\$106.10	\$92.80	\$88.60	\$81.10	\$71.60	\$71.00
GAGE - Taperlock Style		2B		23238		\$155.70							
GAGE - Taperlock Style		3B		23239		\$155.70							
GAGE - Ring-Go		2A		23632		\$209.90							
GAGE - Ring-Go		3A		23633		\$209.90							
GAGE - Ring-NoGo		2A		23634		\$209.90							
GAGE - Ring-NoGo		3A		23635		\$209.90							
<b>7/8"-16 NS</b>													
<i>Recommended Hole Size based on 75% Thread = .8144"</i>													
HAND TAP	3	3B	4	16681	16682	\$81.10	\$79.90	\$77.90	\$64.90	\$52.90	\$46.10	\$43.50	\$40.90
R.H. ROUND DIE 2"OD				13278		\$132.50	\$113.30	\$106.10	\$92.80	\$88.60	\$81.10	\$71.60	\$71.00
GAGE - Taperlock Style		2B		22450		\$226.60							
GAGE - Taperlock Style		3B		22451		\$226.60							
GAGE - Ring-Go		2A		22452		\$287.60							
GAGE - Ring-Go		3A		22453		\$287.60							
GAGE - Ring-NoGo		2A		22454		\$287.60							
GAGE - Ring-NoGo		3A		22455		\$287.60							
<b>7/8"-18 NS</b>													
<i>Recommended Hole Size based on 75% Thread = .8214"</i>													
HAND TAP	3	3B	4	16686	16687	\$81.10	\$79.90	\$77.90	\$64.90	\$52.90	\$46.10	\$43.50	\$40.90
R.H. ROUND DIE 2"OD				13280		\$132.50	\$113.30	\$106.10	\$92.80	\$88.60	\$81.10	\$71.60	\$71.00



TAPS, DIES & GAGES

Click on Item Number for Catalog Listing

SIZE/ DESCRIPTION	GH #	CLASS OF FIT	# FLUTES	ITEM #		1 PC	2 PC	3 PC	6 PC	9 PC	12 PC	24 PC	48 PC
				PLUG	BOTTOM								
<b>7/8"-20 NEF</b>													
<i>Recommended Hole Size based on 75% Thread = .8265"</i>													
HAND TAP	3	3B	6	16691	16692	\$43.80	\$43.80	\$43.80	\$38.90	\$36.20	\$35.10	\$34.30	\$33.90
HAND TAP	5	2B	6	16696	16697	\$66.70	\$65.70	\$64.60	\$53.40	\$40.80	\$38.10	\$36.20	\$36.00
R.H. ROUND DIE 2"OD				13282		\$132.50	\$113.30	\$106.10	\$92.80	\$88.60	\$81.10	\$71.60	\$71.00
GAGE - Taperlock Style		2B		23243		\$235.20							
GAGE - Taperlock Style		3B		23244		\$235.20							
GAGE - Ring-Go		2A		23638		\$256.70							
GAGE - Ring-Go		3A		23639		\$256.70							
GAGE - Ring-NoGo		2A		23640		\$256.70							
GAGE - Ring-NoGo		3A		23641		\$256.70							
<b>7/8"-24 NS</b>													
<i>Recommended Hole Size based on 75% Thread = .834"</i>													
HAND TAP	3	3B	6	16701	16702	\$89.20	\$87.40	\$80.30	\$66.90	\$49.10	\$40.20	\$36.20	\$36.00
R.H. ROUND DIE 2"OD				13284		\$132.50	\$113.30	\$106.10	\$92.80	\$88.60	\$81.10	\$71.60	\$71.00
<b>7/8"-27 NS</b>													
<i>Recommended Hole Size based on 75% Thread = .839"</i>													
HAND TAP	3	3B	6	16706	16707	\$89.20	\$87.40	\$80.30	\$66.90	\$49.10	\$40.20	\$36.20	\$36.00
<b>7/8"-32 NS</b>													
<i>Recommended Hole Size based on 75% Thread = .8447"</i>													
HAND TAP	3	3B	6	16711	16712	\$89.20	\$87.40	\$80.30	\$66.90	\$49.10	\$40.20	\$36.20	\$36.00
R.H. ROUND DIE 2"OD				13286		\$132.50	\$113.30	\$106.10	\$92.80	\$88.60	\$81.10	\$71.60	\$71.00
GAGE - Taperlock Style		2B		22456		\$271.30							
GAGE - Taperlock Style		3B		22457		\$271.30							
GAGE - Ring-Go		2A		22458		\$362.20							
GAGE - Ring-Go		3A		22459		\$362.20							
GAGE - Ring-NoGo		2A		22460		\$362.20							
GAGE - Ring-NoGo		3A		22461		\$362.20							
<b>15/16"-12 NS</b>													
<i>Recommended Hole Size based on 75% Thread = .8567"</i>													
HAND TAP	4	3B	4	16716	16717	\$92.20	\$89.30	\$81.20	\$67.80	\$50.80	\$47.90	\$45.30	\$42.70
R.H. ROUND DIE 2"OD				13288		\$132.50	\$113.30	\$106.10	\$92.80	\$88.60	\$81.10	\$71.60	\$71.00
GAGE - Taperlock Style		2B		22462		\$226.60							
GAGE - Taperlock Style		3B		22463		\$226.60							
GAGE - Ring-Go		2A		22464		\$287.60							
GAGE - Ring-Go		3A		22465		\$287.60							
GAGE - Ring-NoGo		2A		22466		\$287.60							
GAGE - Ring-NoGo		3A		22467		\$287.60							
<b>15/16"-14 NS</b>													
<i>Recommended Hole Size based on 75% Thread = .8681"</i>													
HAND TAP	4	3B	4	16721	16722	\$92.20	\$89.30	\$81.20	\$67.80	\$50.80	\$47.90	\$45.30	\$42.70
R.H. ROUND DIE 2"OD				13290		\$132.50	\$113.30	\$106.10	\$92.80	\$88.60	\$81.10	\$71.60	\$71.00
<b>15/16"-16 NS</b>													
<i>Recommended Hole Size based on 75% Thread = .8769"</i>													
HAND TAP	3	3B	6	16726	16727	\$92.20	\$89.30	\$81.20	\$67.80	\$50.80	\$47.90	\$45.30	\$42.70
R.H. ROUND DIE 2"OD				13292		\$132.50	\$113.30	\$106.10	\$92.80	\$88.60	\$81.10	\$71.60	\$71.00
<b>15/16"-18 NS</b>													
<i>Recommended Hole Size based on 75% Thread = .8839"</i>													
HAND TAP	3	3B	6	16731	16732	\$92.20	\$89.30	\$81.20	\$67.80	\$50.80	\$47.90	\$45.30	\$42.70
R.H. ROUND DIE 2"OD				13294		\$132.50	\$113.30	\$106.10	\$92.80	\$88.60	\$81.10	\$71.60	\$71.00
<b>15/16"-20 NEF</b>													
<i>Recommended Hole Size based on 75% Thread = .889"</i>													
HAND TAP	3	3B	6	16736	16737	\$55.20	\$52.70	\$50.70	\$44.30	\$42.10	\$39.80	\$37.30	\$37.30
HAND TAP	5	2B	6	16741	16742	\$61.50	\$56.60	\$53.20	\$45.40	\$43.50	\$41.30	\$38.70	\$37.30
R.H. ROUND DIE 2"OD				13296		\$132.50	\$113.30	\$106.10	\$92.80	\$88.60	\$81.10	\$71.60	\$71.00



Click on Item Number  
for Catalog Listing

SIZE/ DESCRIPTION	GH #	CLASS OF FIT	# FLUTES	ITEM #		1 PC	2 PC	3 PC	6 PC	9 PC	12 PC	24 PC	48 PC
				PLUG	BOTTOM								
<b>15/16"-20 NEF</b>													
<i>See Previous Page for Recommended Hole Size</i>													
GAGE - Taperlock Style		2B		23248		\$245.90							
GAGE - Taperlock Style		3B		23249		\$245.90							
GAGE - Ring-Go		2A		23644		\$271.20							
GAGE - Ring-Go		3A		23645		\$271.20							
GAGE - Ring-NoGo		2A		23646		\$271.20							
GAGE - Ring-NoGo		3A		23647		\$271.20							
<b>15/16"-32 NS</b>													
<i>Recommended Hole Size based on 75% Thread = .9702"</i>													
HAND TAP	3	3B	6	16756	16757	\$93.90	\$92.00	\$84.50	\$70.40	\$51.70	\$41.30	\$38.70	\$37.30
R.H. ROUND DIE 2"OD				13298		\$132.50	\$113.30	\$106.10	\$92.80	\$88.60	\$81.10	\$71.60	\$71.00
GAGE - Taperlock Style		2B		22468		\$287.60							
GAGE - Taperlock Style		3B		22469		\$287.60							
GAGE - Ring-Go		2A		22470		\$370.40							
GAGE - Ring-Go		3A		22471		\$370.40							
GAGE - Ring-NoGo		2A		22472		\$370.40							
GAGE - Ring-NoGo		3A		22473		\$370.40							
<b>.969"-32</b>													
N-05 LOCKNUT HEX DIE				13702		\$244.00	\$178.80	\$135.70	\$96.20				
<b>1"-5 ACME</b>													
<i>Recommended Hole Size = .800"</i>													
HAND TAP		2G	4	16760		\$129.60	\$107.80	\$105.10	\$87.50	\$73.80	\$72.20	\$69.50	\$66.90
L.H. HAND TAP		2G	4	16764		\$129.60	\$107.80	\$105.10	\$87.50	\$73.80	\$72.20	\$69.50	\$66.90
TANDEM TAP		2G	4	16766		\$233.40	\$186.80	\$130.80	\$125.80	\$121.10	\$121.10	\$121.10	\$121.10
L.H. TANDEM TAP		2G	4	16767		\$233.40	\$186.80	\$130.80	\$125.80	\$121.10	\$121.10	\$121.10	\$121.10
<b>1"-8 ACME</b>													
<i>Recommended Hole Size = .875"</i>													
HAND TAP		2G	4	16770		\$129.60	\$107.80	\$105.10	\$87.50	\$73.80	\$72.20	\$69.50	\$66.90
<b>1"-8 NC</b>													
<i>Recommended Hole Size based on 75% Thread = .8781"</i>													
REGULAR SPIRAL FLUTE TAP	4	3B	4	16789	16790	\$148.00	\$118.30	\$82.90	\$68.20	\$57.80	\$56.80	\$55.60	\$54.80
FAST SPIRAL FLUTE TAP	4	3B	4	17791	17792	\$148.00	\$118.30	\$105.80	\$82.90	\$64.70	\$63.10	\$60.50	\$57.80
L.H. HAND TAP	4	3B	4	16775	16776	\$82.20	\$79.60	\$68.90	\$58.40	\$55.00	\$53.30	\$50.70	\$48.10
HAND TAP	6	2B	4	17918	17919	\$118.60	\$87.20	\$76.80	\$66.30	\$62.70	\$61.10	\$58.50	\$55.90
SPIRAL POINT TAP	4	3B	3	16778		\$113.40	\$111.20	\$102.10	\$85.20	\$75.50	\$64.70	\$58.20	\$55.50
+.005 HAND TAP	11	PLATING	4	16785	16786	\$65.30	\$65.30	\$65.30	\$54.20	\$51.40	\$46.70	\$45.50	\$44.60
+.005 SPIRAL POINT TAP	11	PLATING	3	16783		\$113.40	\$111.20	\$102.10	\$85.20	\$75.50	\$64.70	\$58.20	\$55.50
+.010 HAND TAP	21		4	17732	17733	\$115.80	\$84.50	\$74.00	\$63.60	\$60.00	\$58.40	\$54.70	\$53.10
8" EXTENSION HAND TAP	4	3B	4	16794	16795	\$135.90	\$104.50	\$94.10	\$83.60	\$80.10	\$78.40	\$75.80	\$73.20
10" EXTENSION HAND TAP	4	3B	4	16799	16800	\$149.10	\$117.00	\$107.20	\$96.50	\$92.60	\$90.80	\$88.40	\$86.10
12" EXTENSION HAND TAP	4	3B	4	18109	18110	\$158.70	\$127.30	\$116.90	\$106.40	\$102.90	\$101.20	\$97.50	\$96.00
CARB-I-SERT TAP	4	3B	4	41564	41565	\$475.10	\$466.00	\$450.40	\$419.00	\$414.80	\$406.20	\$389.40	\$386.00
TIN COAT x 8" TAP	4	3B	4	50021		\$162.20	\$130.90	\$120.40	\$110.00	\$106.40	\$104.80	\$102.10	\$99.50
R.H. ROUND DIE 2"OD				13300		\$132.50	\$113.30	\$106.10	\$92.80	\$88.60	\$81.10	\$71.60	\$65.80
L.H. ROUND DIE 2"OD				13301		\$132.50	\$113.30	\$106.10	\$92.80	\$88.60	\$81.10	\$71.60	\$71.00
GAGE - Taperlock Style		2B		23253		\$177.40							
GAGE - Taperlock Style		3B		23254		\$177.40							
GAGE - Ring-Go		2A		23650		\$264.10							
GAGE - Ring-Go		3A		23651		\$264.10							
GAGE - Ring-NoGo		2A		23652		\$264.10							
GAGE - Ring-NoGo		3A		23653		\$264.10							

TAPS, DIES & GAGES

Click on Item Number for Catalog Listing

SIZE/ DESCRIPTION	GH #	CLASS OF FIT	# FLUTES	ITEM #		1 PC	2 PC	3 PC	6 PC	9 PC	12 PC	24 PC	48 PC
				PLUG	BOTTOM								
<b>1"-10 NS</b>													
<i>Recommended Hole Size based on 75% Thread = .9026"</i>													
HAND TAP	4	3B	4	16809	16810	\$92.10	\$90.80	\$88.50	\$73.60	\$55.30	\$52.80	\$49.10	\$46.90
<b>1"-11 55° WHITWORTH PIPE</b>													
<i>Recommended Hole Size: BSPT = 1.1719" / BSPP = 1.1875"</i>													
BSPT TAPER - MODIFIED TAP			5	16812	16813	\$107.60	\$106.00	\$103.30	\$86.10	\$75.60	\$71.20	\$68.80	\$66.10
BSPP PARALLEL - MODIFIED TAP			5	16815	16816	\$107.60	\$106.00	\$103.30	\$86.10	\$75.60	\$71.20	\$68.80	\$66.10
BSPT TAPER - FULL FORM TAP			5	17937		\$258.80	\$251.30	\$242.60	\$231.30	\$227.00	\$198.50	\$195.90	\$193.30
BSPP PARALLEL - FULL FORM TAP			5	17928		\$258.80	\$251.30	\$242.60	\$231.30	\$227.00	\$198.50	\$195.90	\$193.30
GAGE BSPP-Mod. DBL END w/handle				27056		\$477.70							
GAGE BSPT-Mod. w/handle				27017		\$334.60							
<b>1"-11.5 PIPE TAP NPT NPT/F NPS</b>													
<i>Recommended Hole Size NPT = 1.1406" / NPTF = 1.1563"</i>													
NPT/F LEFT HAND TAPER TAP			5	16818		\$161.10	\$139.60	\$130.30	\$111.10	\$96.90	\$80.70	\$77.40	\$68.00
NPT/F 6" EXTENSION TAPER TAP			5	16821		\$154.60	\$150.80	\$149.10	\$144.40	\$139.70	\$135.80	\$120.40	\$118.80
NPT/F 10" EXTENSION TAPER TAP			5	16824		\$210.40	\$207.60	\$205.00	\$199.00	\$188.90	\$184.00	\$178.50	\$177.20
CARB-I-SERT TAP			6	41811		\$795.40	\$780.10	\$663.00	\$612.20	\$596.70	\$566.20	\$544.00	\$540.80
NPT/F COST CUTTER DRILL/ TAP			4	29046		\$335.00	\$319.80	\$313.80	\$304.50	\$291.70	\$277.80	\$268.40	\$254.50
NPT R.H. ROUND DIE 2-1/2"OD				13302		\$187.50	\$158.60	\$152.20	\$147.50	\$146.30	\$134.10	\$118.30	\$117.30
NPS R.H. ROUND DIE 2-1/2"OD				13304		\$305.40	\$265.40	\$184.40	\$161.90				
GAGE L1 NPT PLG w/handle				24386		\$142.20							
GAGE L1 NPT RING				24384		\$258.20							
GAGE L1 NPTF PLG w/handle				24466		\$208.60							
GAGE L3 NPTF PLG w/handle				24468		\$208.60							
GAGE NPTF 6 step Plain Plug w/handle				24548		\$240.00							
GAGE L1 NPTF RING				24510		\$265.60							
GAGE L2 NPTF RING				24512		\$390.90							
GAGE NPTF 6 step Plain Ring				24582		\$383.60							
<b>1"-12 NF</b>													
<i>Recommended Hole Size based on 75% Thread = .9192"</i>													
L.H. HAND TAP	4	3B	4	16829	16830	\$96.10	\$89.10	\$82.70	\$81.10	\$59.60	\$54.00	\$51.40	\$48.70
HAND TAP	6	2B	4	16834	16835	\$108.20	\$106.10	\$97.30	\$81.10	\$59.60	\$54.00	\$51.40	\$48.70
+.005 HAND TAP	11	PLATING	4	16839	16840	\$68.50	\$65.30	\$62.50	\$58.40	\$55.50	\$54.00	\$51.40	\$48.70
CARB-I-SERT TAP	4	3B	4	41567	41568	\$475.10	\$466.00	\$450.40	\$419.00	\$414.80	\$406.20	\$389.40	\$386.00
R.H. ROUND DIE 2"OD				13306		\$132.50	\$113.30	\$106.10	\$92.80	\$88.60	\$81.10	\$71.60	\$65.80
L.H. ROUND DIE 2"OD				13307		\$132.50	\$113.30	\$106.10	\$92.80	\$88.60	\$81.10	\$71.60	\$71.00
GAGE - Taperlock Style		2B		23258		\$177.40							
GAGE - Taperlock Style		3B		23259		\$177.40							
GAGE - Ring-Go		2A		23656		\$264.10							
GAGE - Ring-Go		3A		23657		\$264.10							
GAGE - Ring-NoGo		2A		23658		\$264.10							
GAGE - Ring-NoGo		3A		23659		\$264.10							



Click on Item Number for Catalog Listing

SIZE/ DESCRIPTION	GH #	CLASS OF FIT	# FLUTES	ITEM #		1 PC	2 PC	3 PC	6 PC	9 PC	12 PC	24 PC	48 PC
				PLUG	BOTTOM								
<b>1"-14 NS</b>				<i>Recommended Hole Size based on 75% Thread = .9306"</i>									
L.H. HAND TAP	4	3B	4	16844	16845	\$96.10	\$89.10	\$82.70	\$81.10	\$59.60	\$54.00	\$51.40	\$48.70
SPIRAL POINT TAP	4	3B	3	17906		\$114.20	\$111.20	\$102.10	\$85.20	\$62.40	\$56.70	\$54.10	\$51.50
HAND TAP	6	2B	4	16849	16850	\$108.20	\$106.10	\$97.30	\$81.10	\$59.60	\$54.00	\$51.40	\$48.70
+.005 HAND TAP	11	PLATING	4	16854	16855	\$68.50	\$65.30	\$62.50	\$58.40	\$55.50	\$54.00	\$51.40	\$48.70
R.H. ROUND DIE 2"OD				13308		\$132.50	\$113.30	\$106.10	\$92.80	\$88.60	\$81.10	\$71.60	\$71.00
L.H. ROUND DIE 2"OD				13309		\$132.50	\$113.30	\$106.10	\$92.80	\$88.60	\$81.10	\$71.60	\$71.00
GAGE - Taperlock Style		2B		23263		\$177.40							
GAGE - Taperlock Style		3B		23264		\$177.40							
GAGE - Ring-Go		2A		23662		\$264.10							
GAGE - Ring-Go		3A		23663		\$264.10							
GAGE - Ring-NoGo		2A		23664		\$264.10							
GAGE - Ring-NoGo		3A		23665		\$264.10							
<b>1"-16 NS</b>				<i>Recommended Hole Size based on 75% Thread = .9394"</i>									
L.H. HAND TAP	3	3B	6	17695	17696	\$114.40	\$112.20	\$103.00	\$85.80	\$63.00	\$51.60	\$49.00	\$44.40
HAND TAP	3	3B	6	16859	16860	\$92.10	\$90.80	\$88.50	\$73.60	\$55.30	\$52.80	\$49.10	\$46.90
R.H. ROUND DIE 2"OD				13310		\$132.50	\$113.30	\$106.10	\$92.80	\$88.60	\$81.10	\$71.60	\$71.00
GAGE - Taperlock Style		2B		22486		\$226.60							
GAGE - Taperlock Style		3B		22487		\$226.60							
GAGE - Ring-Go		2A		22488		\$287.60							
GAGE - Ring-Go		3A		22489		\$287.60							
GAGE - Ring-NoGo		2A		22490		\$287.60							
GAGE - Ring-NoGo		3A		22491		\$287.60							
<b>1"-18 NS</b>				<i>Recommended Hole Size based on 75% Thread = .9464"</i>									
HAND TAP	3	3B	6	16864	16865	\$92.10	\$90.80	\$88.50	\$73.60	\$55.30	\$52.80	\$49.10	\$46.90
R.H. ROUND DIE 2"OD				13312		\$132.50	\$113.30	\$106.10	\$92.80	\$88.60	\$81.10	\$71.60	\$71.00
<b>1"-20 NEF</b>				<i>Recommended Hole Size based on 75% Thread = .9515"</i>									
L.H. HAND TAP	3	3B	6	17580	17581	\$65.40	\$64.30	\$62.70	\$57.10	\$54.40	\$53.10	\$49.00	\$44.40
HAND TAP	3	3B	6	16869	16870	\$65.00	\$59.70	\$57.10	\$52.70	\$47.90	\$46.10	\$43.80	\$43.50
HAND TAP	5	2B	6	16874	16875	\$86.40	\$85.10	\$82.90	\$69.20	\$53.60	\$50.10	\$48.20	\$44.40
R.H. ROUND DIE 2"OD				13314		\$132.50	\$113.30	\$106.10	\$92.80	\$88.60	\$81.10	\$71.60	\$71.00
GAGE - Taperlock Style		2B		23268		\$256.70							
GAGE - Taperlock Style		3B		23269		\$256.70							
GAGE - Ring-Go		2A		23668		\$296.60							
GAGE - Ring-Go		3A		23669		\$296.60							
GAGE - Ring-NoGo		2A		23670		\$296.60							
GAGE - Ring-NoGo		3A		23671		\$296.60							
<b>1"-24 NS</b>				<i>Recommended Hole Size based on 75% Thread = .959"</i>									
HAND TAP	3	3B	6	16879	16880	\$92.10	\$90.80	\$88.50	\$73.60	\$55.30	\$52.80	\$49.10	\$46.90
R.H. ROUND DIE 2"OD				13316		\$132.50	\$113.30	\$106.10	\$92.80	\$88.60	\$81.10	\$71.60	\$71.00
<b>1"-27 NS</b>				<i>Recommended Hole Size based on 75% Thread = .964"</i>									
HAND TAP	3	3B	6	16884	16885	\$92.10	\$90.80	\$88.50	\$73.60	\$55.30	\$52.80	\$49.10	\$46.90
R.H. ROUND DIE 2"OD				13318		\$132.50	\$113.30	\$106.10	\$92.80	\$88.60	\$81.10	\$71.60	\$71.00
<b>1"-32 NS</b>				<i>Recommended Hole Size based on 75% Thread = .9697"</i>									
HAND TAP	3	3B	6	16889	16890	\$92.10	\$90.80	\$88.50	\$73.60	\$55.30	\$52.80	\$49.10	\$46.90
R.H. ROUND DIE 2"OD				13320		\$132.50	\$113.30	\$106.10	\$92.80	\$88.60	\$81.10	\$71.60	\$71.00
GAGE - Taperlock Style		2B		22492		\$287.60							

TAPS, DIES & GAGES

Click on Item Number for Catalog Listing

SIZE/ DESCRIPTION	GH #	CLASS OF FIT	# FLUTES	ITEM #		1 PC	2 PC	3 PC	6 PC	9 PC	12 PC	24 PC	48 PC
				PLUG	BOTTOM								
<b>1"-32 NS</b>				<i>See Previous Page for Recommended Hole Size</i>									
GAGE - Taperlock Style		3B		22493		\$287.60							
GAGE - Ring-Go		2A		22494		\$370.40							
GAGE - Ring-Go		3A		22495		\$370.40							
GAGE - Ring-NoGo		2A		22496		\$370.40							
GAGE - Ring-NoGo		3A		22497		\$370.40							
<b>1 1/16"-12 NS</b>				<i>Recommended Hole Size based on 75% Thread = .9817"</i>									
<b>HAND TAP</b>	4		4	17714	17715	\$126.90	\$95.50	\$85.40	\$75.20	\$70.70	\$69.10	\$66.40	
<b>HAND TAP</b>	5	3B	4	16893	16894	\$71.90	\$69.20	\$68.20	\$66.70	\$65.40	\$64.40	\$61.70	
<b>HAND TAP</b>	7	2B	4	16897	16898	\$71.90	\$69.20	\$68.20	\$66.70	\$65.40	\$64.40	\$61.70	
<b>TiN COAT/HAND TAP</b>	4		4		50031	\$143.90	\$112.50	\$102.50	\$92.20	\$87.70	\$86.20	\$83.40	
R.H. ROUND DIE 2"OD				13322		\$142.50	\$121.20	\$114.30	\$92.80	\$88.60	\$81.10	\$71.60	
GAGE - Taperlock Style		2B		24982		\$282.10							
GAGE - Taperlock Style		3B		24983		\$282.10							
GAGE - Ring-Go		2A		22498		\$264.60							
GAGE - Ring-Go		3A		22499		\$264.60							
GAGE - Ring-NoGo		2A		22500		\$264.60							
GAGE - Ring-NoGo		3A		22501		\$264.60							
<b>1 1/16"-14 NS</b>				<i>Recommended Hole Size based on 75% Thread = .9931"</i>									
<b>HAND TAP</b>	5	3B	6	16901	16902	\$91.20	\$89.60	\$87.30	\$72.80	\$54.70	\$50.90	\$48.30	
<b>1 1/16"-16 NS</b>				<i>Recommended Hole Size based on 75% Thread = 1.002"</i>									
<b>HAND TAP</b>	4	3B	6	16905	16906	\$91.20	\$89.60	\$87.30	\$72.80	\$54.70	\$50.90	\$48.30	
<b>HAND TAP</b>	6	2B	6	16909	16910	\$91.20	\$89.60	\$87.30	\$72.80	\$54.70	\$50.90	\$48.30	
R.H. ROUND DIE 2"OD				13326		\$142.50	\$121.20	\$114.30	\$92.80	\$88.60	\$81.10	\$71.60	
GAGE - Taperlock Style		2B		22502		\$241.50							
GAGE - Taperlock Style		3B		22503		\$241.50							
GAGE - Ring-Go		2A		22504		\$287.60							
GAGE - Ring-Go		3A		22505		\$287.60							
GAGE - Ring-NoGo		2A		22506		\$287.60							
GAGE - Ring-NoGo		3A		22507		\$287.60							
<b>1 1/16"-18 NEF</b>				<i>Recommended Hole Size based on 75% Thread = 1.008"</i>									
<b>HAND TAP</b>	4	3B	6	16913	16914	\$73.80	\$72.70	\$70.90	\$59.00	\$54.70	\$50.90	\$48.30	
<b>HAND TAP</b>	6	2B	6	16917	16918	\$80.40	\$79.20	\$77.20	\$64.30	\$54.70	\$50.90	\$48.30	
R.H. ROUND DIE 2"OD				13330		\$142.50	\$121.20	\$114.30	\$92.80	\$88.60	\$81.10	\$71.60	
GAGE - Taperlock Style		2B		23273		\$285.90							
GAGE - Taperlock Style		3B		23274		\$285.90							
GAGE - Ring-Go		2A		23674		\$327.30							
GAGE - Ring-Go		3A		23675		\$327.30							
GAGE - Ring-NoGo		2A		23676		\$327.30							
GAGE - Ring-NoGo		3A		23677		\$327.30							
<b>1 1/16"-20 NS</b>				<i>Recommended Hole Size based on 75% Thread = 1.014"</i>									
<b>HAND TAP</b>	4	3B	6	16921	16922	\$102.00	\$100.10	\$91.90	\$76.50	\$56.30	\$50.90	\$48.30	
R.H. ROUND DIE 2"OD				13332		\$142.50	\$121.20	\$114.30	\$92.80	\$88.60	\$81.10	\$71.60	
GAGE - Taperlock Style		2B		22508		\$256.50							
GAGE - Taperlock Style		3B		22509		\$256.50							
GAGE - Ring-Go		2A		22510		\$287.60							



Click on Item Number  
for Catalog Listing

SIZE/ DESCRIPTION	GH #	CLASS OF FIT	# FLUTES	ITEM #		1 PC	2 PC	3 PC	6 PC	9 PC	12 PC	24 PC	48 PC
				PLUG	BOTTOM								
<b>1 1/16"-20 NS</b>													
<i>See Previous Page for Recommended Hole Size</i>													
GAGE - Ring-Go		3A		22511		\$287.60							
GAGE - Ring-NoGo		2A		22512		\$287.60							
GAGE - Ring-NoGo		3A		22513		\$287.60							
<b>1 1/16"-24 NS</b>													
<i>Recommended Hole Size based on 75% Thread = 1.021"</i>													
HAND TAP	4	3B	6	16925	16926	\$102.00	\$100.10	\$91.90	\$76.50	\$56.30	\$50.90	\$48.30	
<b>1 1/8"-5 ACME</b>													
<i>Recommended Hole Size = .925"</i>													
HAND TAP		2G	4	16929		\$125.10	\$123.20	\$120.00	\$100.10	\$94.80	\$92.80	\$91.00	
L.H. HAND TAP		2G	4	16933		\$125.10	\$123.20	\$120.00	\$100.10	\$94.80	\$92.80	\$91.00	
TANDEM TAP		2G	4	16935		\$256.70	\$205.40	\$201.00	\$193.70	\$190.10	\$188.50	\$185.90	
L.H. TANDEM TAP		2G	4	16936		\$256.70	\$205.40	\$201.00	\$193.70	\$190.10	\$188.50	\$185.90	
<b>1 1/8"-7 NC</b>													
<i>Recommended Hole Size based on 75% Thread = .9857"</i>													
L.H. HAND TAP	4	3B	4	16939	16940	\$127.90	\$93.90	\$83.40	\$73.00	\$69.40	\$67.80	\$65.20	
R.H. ROUND DIE 2-1/2"OD				13334		\$187.50	\$158.60	\$152.20	\$133.20	\$127.00	\$116.70	\$103.70	
L.H. ROUND DIE 2-1/2"OD				13335		\$187.50	\$158.60	\$152.20	\$133.20	\$127.00	\$116.70	\$103.70	
GAGE - Taperlock Style		2B		23278		\$220.90							
GAGE - Taperlock Style		3B		23279		\$220.90							
GAGE - Ring-Go		2A		23680		\$307.60							
GAGE - Ring-Go		3A		23681		\$307.60							
GAGE - Ring-NoGo		2A		23682		\$307.60							
GAGE - Ring-NoGo		3A		23683		\$307.60							
<b>1 1/8"-8 NS</b>													
<i>Recommended Hole Size based on 75% Thread = 1.003"</i>													
HAND TAP	5	3B	4	16943	16944	\$73.90	\$73.90	\$73.90	\$73.00	\$69.40	\$67.80	\$65.20	
TIN COAT/HAND TAP	5	3B	4		50022	\$91.00	\$91.00	\$91.00	\$90.00	\$86.50	\$84.80	\$82.20	
R.H. ROUND DIE 2-1/2"OD				13464		\$187.50	\$158.60	\$152.20	\$133.20	\$127.00	\$116.70	\$103.70	
GAGE - Taperlock Style		2B		22520		\$241.50							
GAGE - Taperlock Style		3B		22521		\$241.50							
GAGE - Ring-Go		2A		22522		\$287.60							
GAGE - Ring-Go		3A		22523		\$287.60							
GAGE - Ring-NoGo		2A		22524		\$287.60							
GAGE - Ring-NoGo		3A		22525		\$287.60							
<b>1 1/8"-10 NS</b>													
<i>Recommended Hole Size based on 75% Thread = 1.027"</i>													
HAND TAP	5	3B	4	16947	16948	\$143.10	\$114.50	\$80.20	\$73.00	\$69.40	\$67.80	\$65.20	
<b>1 1/8"-12 NF</b>													
<i>Recommended Hole Size based on 75% Thread = 1.044"</i>													
L.H. HAND TAP	4	3B	4	16951	16952	\$143.10	\$114.50	\$80.20	\$73.00	\$69.40	\$67.80	\$65.20	
HAND TAP	6	2B	4	16955	16956	\$143.10	\$114.50	\$80.20	\$73.00	\$69.40	\$67.80	\$65.20	
+.005 HAND TAP	12	PLATING	4	17776	17777	\$155.20	\$124.20	\$90.70	\$76.30	\$72.80	\$71.10	\$68.50	
R.H. ROUND DIE 2-1/2"OD				13336		\$187.50	\$158.60	\$152.20	\$133.20	\$127.00	\$116.70	\$103.70	
L.H. ROUND DIE 2-1/2"OD				13337		\$187.50	\$158.60	\$152.20	\$133.20	\$127.00	\$116.70	\$103.70	
GAGE - Taperlock Style		2B		23283		\$221.20							
GAGE - Taperlock Style		3B		23284		\$221.20							
GAGE - Ring-Go		2A		23686		\$308.20							
GAGE - Ring-Go		3A		23687		\$308.20							
GAGE - Ring-NoGo		2A		23688		\$308.20							
GAGE - Ring-NoGo		3A		23689		\$308.20							
<b>1 1/8"-14 NS</b>													
<i>Recommended Hole Size based on 75% Thread = 1.055"</i>													
HAND TAP	5	3B	6	16959	16960	\$115.50	\$101.60	\$98.20	\$80.80	\$57.70	\$54.70	\$52.10	



TAPS, DIES & GAGES

Click on Item Number for Catalog Listing

SIZE/ DESCRIPTION	GH #	CLASS OF FIT	# FLUTES	ITEM #		1 PC	2 PC	3 PC	6 PC	9 PC	12 PC	24 PC	48 PC
				PLUG	BOTTOM								
<b>1 1/8"-16 NS</b>						<i>Recommended Hole Size based on 75% Thread = 1.064"</i>							
<b>HAND TAP</b>	4	3B	6	16963	16964	\$60.60	\$60.60	\$60.60	\$59.90	\$57.70	\$54.70	\$52.10	
R.H. ROUND DIE 2-1/2"OD				13340		\$187.50	\$158.60	\$152.20	\$133.20	\$127.00	\$116.70	\$103.70	
GAGE - Taperlock Style		2B		22532		\$241.50							
GAGE - Taperlock Style		3B		22533		\$241.50							
GAGE - Ring-Go		2A		22534		\$287.60							
GAGE - Ring-Go		3A		22535		\$287.60							
GAGE - Ring-NoGo		2A		22536		\$287.60							
GAGE - Ring-NoGo		3A		22537		\$287.60							
<b>1 1/8"-18 NEF</b>						<i>Recommended Hole Size based on 75% Thread = 1.071"</i>							
<b>HAND TAP</b>	4	3B	6	16967	16968	\$75.40	\$74.20	\$72.40	\$59.90	\$57.70	\$54.70	\$52.10	
<b>HAND TAP</b>	6	2B	6	16971	16972	\$102.30	\$90.00	\$87.00	\$71.60	\$57.70	\$54.70	\$52.10	
R.H. ROUND DIE 2-1/2"OD				13342		\$187.50	\$158.60	\$152.20	\$133.20	\$127.00	\$116.70	\$103.70	
GAGE - Taperlock Style		2B		23288		\$283.80							
GAGE - Taperlock Style		3B		23289		\$283.80							
GAGE - Ring-Go		2A		23692		\$327.30							
GAGE - Ring-Go		3A		23693		\$327.30							
GAGE - Ring-NoGo		2A		23694		\$327.30							
GAGE - Ring-NoGo		3A		23695		\$327.30							
<b>1 1/8"-20 NS</b>						<i>Recommended Hole Size based on 75% Thread = 1.076"</i>							
<b>HAND TAP</b>	4	3B	6	16975	16976	\$102.30	\$90.00	\$87.00	\$71.60	\$57.70	\$54.70	\$52.10	
R.H. ROUND DIE 2-1/2"OD				13344		\$187.50	\$158.60	\$152.20	\$133.20	\$127.00	\$116.70	\$103.70	
GAGE - Taperlock Style		2B		22538		\$256.50							
GAGE - Taperlock Style		3B		22539		\$256.50							
GAGE - Ring-Go		2A		22540		\$287.60							
GAGE - Ring-Go		3A		22541		\$287.60							
GAGE - Ring-NoGo		2A		22542		\$287.60							
GAGE - Ring-NoGo		3A		22543		\$287.60							
<b>1 1/8"-24 NS</b>						<i>Recommended Hole Size based on 75% Thread = 1.084"</i>							
<b>HAND TAP</b>	4	3B	6	16979	16980	\$115.30	\$101.60	\$98.10	\$80.70	\$57.70	\$54.70	\$52.10	
<b>1 1/8"-28 NS</b>						<i>Recommended Hole Size based on 75% Thread = 1.0903"</i>							
<b>HAND TAP</b>	4	3B	6	18114	18115	\$115.30	\$101.60	\$98.10	\$80.70	\$59.20	\$57.50	\$54.90	
GAGE - Taperlock Style		2B		22544		\$305.30							
GAGE - Taperlock Style		3B		22545		\$305.30							
GAGE - Ring-Go		2A		22546		\$424.60							
GAGE - Ring-Go		3A		22547		\$424.60							
GAGE - Ring-NoGo		2A		22548		\$424.60							
GAGE - Ring-NoGo		3A		22549		\$424.60							
<b>1 1/8"-32 NS</b>						<i>Recommended Hole Size based on 75% Thread = 1.095"</i>							
<b>HAND TAP</b>	4	3B	8	16987	16988	\$115.30	\$101.60	\$98.10	\$80.70	\$57.70	\$54.70	\$52.10	
<b>1.173"-18</b>													
N-06 LOCKNUT HEX DIE				13703		\$299.40	\$242.70	\$186.40	\$140.90				
<b>1 3/16"-12 NS</b>						<i>Recommended Hole Size based on 75% Thread = 1.106"</i>							
<b>HAND TAP</b>	5	3B	6	16991	16992	\$102.80	\$101.20	\$99.50	\$93.60	\$90.00	\$88.40	\$85.70	
R.H. ROUND DIE 2-1/2"OD				13346		\$187.50	\$158.60	\$152.20	\$133.20	\$127.00	\$116.70	\$103.70	
GAGE - Taperlock Style		2B		24987		\$298.50							





Click on Item Number  
for Catalog Listing

SIZE/ DESCRIPTION	GH #	CLASS OF FIT	# FLUTES	ITEM #		1 PC	2 PC	3 PC	6 PC	9 PC	12 PC	24 PC	48 PC
				PLUG	BOTTOM								
<b>1 3/16"-12 NS</b>						<i>See Previous Page for Recommended Hole Size</i>							
GAGE - Taperlock Style		3B		24988		\$298.50							
GAGE - Ring-Go		2A		22550		\$294.40							
GAGE - Ring-Go		3A		22551		\$294.40							
GAGE - Ring-NoGo		2A		22552		\$294.40							
GAGE - Ring-NoGo		3A		22553		\$294.40							
<b>1 3/16"-14 NS</b>						<i>Recommended Hole Size based on 75% Thread = 1.118"</i>							
HAND TAP	5	3B	6	16995	16996	\$123.90	\$109.00	\$105.30	\$86.70	\$62.00	\$60.30	\$57.70	
<b>1 3/16"-16 NS</b>						<i>Recommended Hole Size based on 75% Thread = 1.127"</i>							
HAND TAP	4	3B	6	16999	17000	\$109.00	\$109.00	\$105.30	\$86.70	\$62.00	\$60.30	\$57.70	
HAND TAP	6	2B	6	17003	17004	\$109.00	\$109.00	\$105.30	\$86.70	\$62.00	\$60.30	\$57.70	
GAGE - Taperlock Style		2B		22554		\$241.50							
GAGE - Taperlock Style		3B		22555		\$241.50							
GAGE - Ring-Go		2A		22556		\$302.60							
GAGE - Ring-Go		3A		22557		\$302.60							
GAGE - Ring-NoGo		2A		22558		\$302.60							
GAGE - Ring-NoGo		3A		22559		\$302.60							
<b>1 3/16"-18 NEF</b>						<i>Recommended Hole Size based on 75% Thread = 1.134"</i>							
HAND TAP	4	3B	6	17007	17008	\$96.70	\$94.60	\$92.80	\$86.70	\$62.00	\$60.30	\$57.70	
HAND TAP	6	2B	6	17011	17012	\$109.00	\$109.00	\$105.30	\$86.70	\$62.00	\$60.30	\$57.70	
R.H. ROUND DIE 2-1/2"OD				13350		\$187.50	\$158.60	\$152.20	\$133.20	\$127.00	\$116.70	\$103.70	
GAGE - Taperlock Style		2B		23293		\$305.50							
GAGE - Taperlock Style		3B		23294		\$305.50							
GAGE - Ring-Go		2A		23698		\$350.90							
GAGE - Ring-Go		3A		23699		\$350.90							
GAGE - Ring-NoGo		2A		23700		\$350.90							
GAGE - Ring-NoGo		3A		23701		\$350.90							
<b>1 3/16"-20 NS</b>						<i>Recommended Hole Size based on 75% Thread = 1.139"</i>							
HAND TAP	4	3B	6	17015	17016	\$130.00	\$114.50	\$110.50	\$91.00	\$65.00	\$60.30	\$57.70	
GAGE - Taperlock Style		2B		22560		\$256.50							
GAGE - Taperlock Style		3B		22561		\$256.50							
GAGE - Ring-Go		2A		22562		\$302.60							
GAGE - Ring-Go		3A		22563		\$302.60							
GAGE - Ring-NoGo		2A		22564		\$302.60							
GAGE - Ring-NoGo		3A		22565		\$302.60							
<b>1 1/4"-5 ACME</b>						<i>Recommended Hole Size = 1.050"</i>							
HAND TAP		2G	4	17019		\$158.70	\$156.30	\$152.30	\$134.10	\$126.10	\$123.60	\$117.50	
L.H. HAND TAP		2G	4	17023		\$158.70	\$156.30	\$152.30	\$134.10	\$126.10	\$123.60	\$117.50	
TANDEM TAP		2G	4	17025		\$302.80	\$267.90	\$242.30	\$225.40	\$222.10	\$215.10	\$210.00	
L.H. TANDEM TAP		2G	4	17026		\$302.80	\$267.90	\$242.30	\$225.40	\$222.10	\$215.10	\$210.00	
<b>1 1/4"-7 NC</b>						<i>Recommended Hole Size based on 75% Thread = 1.110"</i>							
L.H. HAND TAP	4	3B	4	17029	17030	\$175.60	\$141.50	\$117.50	\$101.80	\$92.10	\$82.30	\$79.10	
SPIRAL POINT TAP	4	3B	3	17920		\$181.70	\$145.40	\$105.80	\$91.80	\$88.20	\$86.60	\$84.00	
HAND TAP	8	2B	4	17033	17034	\$175.60	\$141.50	\$117.50	\$101.80	\$92.10	\$82.30	\$79.10	
+.005 HAND TAP	12	PLATING	4	17753	17754	\$175.60	\$141.50	\$117.50	\$101.80	\$92.10	\$82.30	\$79.10	
10" EXTENSION TAP	4	3B	4	17037	17038	\$265.60	\$244.70	\$239.30	\$205.10	\$163.00	\$132.60	\$121.10	
12" EXTENSION TAP	4	3B	4	17041	17042	\$303.30	\$283.90	\$277.80	\$243.60	\$201.00	\$172.80	\$166.10	

TAPS, DIES & GAGES

Click on Item Number for Catalog Listing

SIZE/ DESCRIPTION	GH #	CLASS OF FIT	# FLUTES	ITEM #		1 PC	2 PC	3 PC	6 PC	9 PC	12 PC	24 PC	48 PC
				PLUG	BOTTOM								
<b>1 1/4"-7 NC</b>						<i>See Previous Page for Recommended Hole Size</i>							
CARB-I-SERT TAP	4	3B	4	41570	41571	\$565.40	\$560.90	\$552.60	\$542.30	\$523.40	\$505.00	\$496.60	
R.H. ROUND DIE 2-1/2"OD				13352		\$187.50	\$158.60	\$152.20	\$133.20	\$127.00	\$116.70	\$103.70	
L.H. ROUND DIE 2-1/2"OD				13353		\$187.50	\$158.60	\$152.20	\$133.20	\$127.00	\$116.70	\$103.70	
GAGE - Taperlock Style		2B		23298		\$237.00							
GAGE - Taperlock Style		3B		23299		\$237.00							
GAGE - Ring-Go		2A		23704		\$332.90							
GAGE - Ring-Go		3A		23705		\$332.90							
GAGE - Ring-NoGo		2A		23706		\$332.90							
GAGE - Ring-NoGo		3A		23707		\$332.90							
<b>1 1/4"-8 NS</b>						<i>Recommended Hole Size based on 75% Thread = 1.128"</i>							
HAND TAP	5	3B	4	17045	17046	\$88.60	\$88.60	\$88.60	\$88.60	\$88.60	\$82.30	\$79.10	
10" EXTENSION TAP	5	3B	4	17049	17050	\$265.60	\$244.70	\$239.30	\$205.10	\$163.00	\$132.60	\$121.10	
12" EXTENSION TAP	5	3B	4	17053	17054	\$303.30	\$283.90	\$277.80	\$243.60	\$201.00	\$172.80	\$166.10	
R.H. ROUND DIE 2-1/2"OD				13466		\$187.50	\$158.60	\$152.20	\$133.20	\$127.00	\$116.70	\$103.70	
GAGE - Taperlock Style		2B		22572		\$241.50							
GAGE - Taperlock Style		3B		22573		\$241.50							
GAGE - Ring-Go		2A		22574		\$302.60							
GAGE - Ring-Go		3A		22575		\$302.60							
GAGE - Ring-NoGo		2A		22576		\$302.60							
GAGE - Ring-NoGo		3A		22577		\$302.60							
<b>1 1/4"-10 NS</b>						<i>Recommended Hole Size based on 75% Thread = 1.152"</i>							
HAND TAP	5	3B	4	17057	17058	\$175.60	\$141.50	\$117.50	\$101.80	\$92.10	\$82.30	\$79.10	
<b>1 1/4"-11 55° WHITWORTH PIPE</b>						<i>Recommended Hole Size: BSPT = 1.500" / BSPP = 1.5469"</i>							
BSPT TAPER - MODIFIED TAP			5	17060	17061	\$160.60	\$154.60	\$143.00	\$139.20	\$135.70	\$134.00	\$131.40	
BSPP PARALLEL - MODIFIED TAP			5	17063	17064	\$160.60	\$154.60	\$143.00	\$139.20	\$135.70	\$134.00	\$131.40	
BSPT TAPER - FULL FORM TAP			5	17938		\$342.20	\$311.30	\$300.80	\$290.40	\$286.80	\$285.10	\$282.50	
BSPP PARALLEL - FULL FORM TAP			5	17929		\$342.20	\$311.30	\$300.80	\$290.40	\$286.80	\$285.10	\$282.50	
GAGE BSPP-Mod. DBL END w/handle				27059		\$551.10							
GAGE BSPT-Mod. w/handle				27020		\$350.90							
<b>1 1/4"-11.5 PIPE TAP NPS NPSF NPT/F</b>						<i>Recommended Hole Size: NPT = 1.4844" / NPTF = 1.500" / NPSC = 1.500" / NPSM = 1.5469" / NPSF = 1.5050"</i>							
NPT/F LEFT HAND TAPER TAP			5	17066		\$167.60	\$163.00	\$156.60	\$118.90	\$115.30	\$113.60	\$111.00	
NPS STRAIGHT TAP			5	17069		\$167.60	\$163.00	\$156.60	\$118.90	\$115.30	\$113.60	\$111.00	
NPSF STRAIGHT TAP			5	17072		\$167.60	\$163.00	\$156.60	\$118.90	\$115.30	\$113.60	\$111.00	
GAGE L1 NPT PLG w/handle				24389		\$158.70							
GAGE L1 NPT RING				24387		\$282.10							
GAGE L1 NPTF PLG w/handle				24474		\$226.80							
GAGE L3 NPTF PLG w/handle				24476		\$226.80							
GAGE NPTF 6 step Plain Plug w/handle				24552		\$267.50							
GAGE L1 NPTF RING				24514		\$295.40							
GAGE L2 NPTF RING				24516		\$429.90							
GAGE NPTF 6 step Plain Ring				24586		\$387.00							



Click on Item Number  
for Catalog Listing

SIZE/ DESCRIPTION	GH #	CLASS OF FIT	# FLUTES	ITEM #		1 PC	2 PC	3 PC	6 PC	9 PC	12 PC	24 PC	48 PC
				PLUG	BOTTOM								
<b>1 1/4"-12 NF</b>						<i>Recommended Hole Size based on 75% Thread = 1.169"</i>							
L.H. HAND TAP	4	3B	6	17076	17077	\$175.60	\$141.50	\$117.50	\$101.80	\$92.10	\$82.30	\$79.10	
HAND TAP	6	2B	6	17080	17081	\$175.60	\$141.50	\$117.50	\$101.80	\$92.10	\$82.30	\$79.10	
R.H. ROUND DIE 2-1/2"OD				13354		\$187.50	\$158.60	\$152.20	\$133.20	\$127.00	\$116.70	\$103.70	
L.H. ROUND DIE 2-1/2"OD				13355		\$187.50	\$158.60	\$152.20	\$133.20	\$127.00	\$116.70	\$103.70	
GAGE - Taperlock Style		2B		23303		\$237.00							
GAGE - Taperlock Style		3B		23304		\$237.00							
GAGE - Ring-Go		2A		23710		\$332.90							
GAGE - Ring-Go		3A		23711		\$332.90							
GAGE - Ring-NoGo		2A		23712		\$332.90							
GAGE - Ring-NoGo		3A		23713		\$332.90							
<b>1 1/4"-14 NS</b>						<i>Recommended Hole Size based on 75% Thread = 1.180"</i>							
HAND TAP	5	3B	6	17084	17085	\$106.70	\$100.00	\$94.30	\$88.70	\$70.60	\$61.30	\$58.70	
<b>1 1/4"-16 NS</b>						<i>Recommended Hole Size based on 75% Thread = 1.189"</i>							
HAND TAP	4	3B	6	17088	17089	\$106.70	\$100.00	\$94.30	\$88.70	\$70.60	\$61.30	\$58.70	
R.H. ROUND DIE 2-1/2"OD				13356		\$183.90	\$155.70	\$149.40	\$130.60	\$124.70	\$114.40	\$101.90	
GAGE - Taperlock Style		2B		22584		\$241.50							
GAGE - Taperlock Style		3B		22585		\$241.50							
GAGE - Ring-Go		2A		22586		\$302.60							
GAGE - Ring-Go		3A		22587		\$302.60							
GAGE - Ring-NoGo		2A		22588		\$302.60							
GAGE - Ring-NoGo		3A		22589		\$302.60							
<b>1 1/4"-18 NEF</b>						<i>Recommended Hole Size based on 75% Thread = 1.196"</i>							
HAND TAP	4	3B	6	17092	17093	\$97.80	\$95.80	\$91.90	\$88.70	\$70.60	\$61.30	\$58.70	
HAND TAP	6	2B	6	17096	17097	\$112.60	\$106.00	\$99.60	\$90.10	\$70.60	\$61.30	\$58.70	
R.H. ROUND DIE 2-1/2"OD				13358		\$183.90	\$155.70	\$149.40	\$130.60	\$124.70	\$114.40	\$101.90	
GAGE - Taperlock Style		2B		23308		\$305.50							
GAGE - Taperlock Style		3B		23309		\$305.50							
GAGE - Ring-Go		2A		23716		\$350.90							
GAGE - Ring-Go		3A		23717		\$350.90							
GAGE - Ring-NoGo		2A		23718		\$350.90							
GAGE - Ring-NoGo		3A		23719		\$350.90							
<b>1 1/4"-20 NS</b>						<i>Recommended Hole Size based on 75% Thread = 1.201"</i>							
HAND TAP	4	3B	6	17100	17101	\$112.60	\$106.00	\$99.60	\$90.10	\$70.60	\$61.30	\$58.70	
R.H. ROUND DIE 2-1/2"OD				13360		\$187.50	\$158.60	\$152.20	\$133.20	\$127.00	\$116.70	\$103.70	
GAGE - Taperlock Style		2B		22590		\$256.50							
GAGE - Taperlock Style		3B		22591		\$256.50							
GAGE - Ring-Go		2A		22592		\$302.60							
GAGE - Ring-Go		3A		22593		\$302.60							
GAGE - Ring-NoGo		2A		22594		\$302.60							
GAGE - Ring-NoGo		3A		22595		\$302.60							
<b>1 1/4"-24 NS</b>						<i>Recommended Hole Size based on 75% Thread = 1.209"</i>							
HAND TAP	4	3B	8	17104	17105	\$139.10	\$111.30	\$109.00	\$99.50	\$80.00	\$70.70	\$68.10	
R.H. ROUND DIE 2-1/2"OD				13362		\$187.50	\$158.60	\$152.20	\$133.20	\$127.00	\$116.70	\$103.70	
<b>1 1/4"-32 NS</b>						<i>Recommended Hole Size based on 75% Thread = 1.219"</i>							
HAND TAP	4	3B	10	17108	17109	\$139.10	\$111.30	\$109.00	\$99.50	\$80.00	\$70.70	\$68.10	

TAPS, DIES & GAGES

Click on Item Number for Catalog Listing

SIZE/ DESCRIPTION	GH #	CLASS OF FIT	# FLUTES	ITEM #		1 PC	2 PC	3 PC	6 PC	9 PC	12 PC	24 PC	48 PC
				PLUG	BOTTOM								
<b>1 5/16"-12 NS</b>						<i>Recommended Hole Size based on 75% Thread = 1.232"</i>							
HAND TAP	5	3B	6	17112	17113	\$87.10	\$87.10	\$87.10	\$87.10	\$87.10	\$87.10	\$87.10	
HAND TAP	8	2B	6	17116	17117	\$92.50	\$92.50	\$92.50	\$87.10	\$87.10	\$87.10	\$87.10	
R.H. ROUND DIE 2-1/2"OD				13364		\$194.90	\$167.70	\$157.40	\$133.20	\$127.00	\$116.70	\$103.70	
GAGE - Taperlock Style		2B		24992		\$327.30							
GAGE - Taperlock Style		3B		24993		\$327.30							
GAGE - Ring-Go		2A		22596		\$301.20							
GAGE - Ring-Go		3A		22597		\$301.20							
GAGE - Ring-NoGo		2A		22598		\$301.20							
GAGE - Ring-NoGo		3A		22599		\$301.20							
<b>1 5/16"-16 NS</b>						<i>Recommended Hole Size based on 75% Thread = 1.252"</i>							
HAND TAP	4	3B	6	17124	17125	\$127.30	\$124.70	\$114.60	\$100.50	\$94.90	\$85.10	\$79.80	
HAND TAP	6	2B	6	17128	17129	\$127.30	\$124.70	\$114.60	\$100.50	\$94.90	\$85.10	\$79.80	
GAGE - Taperlock Style		2B		22600		\$256.50							
GAGE - Taperlock Style		3B		22601		\$256.50							
GAGE - Ring-Go		2A		22602		\$317.50							
GAGE - Ring-Go		3A		22603		\$317.50							
GAGE - Ring-NoGo		2A		22604		\$317.50							
GAGE - Ring-NoGo		3A		22605		\$317.50							
<b>1 5/16"-18 NEF</b>						<i>Recommended Hole Size based on 75% Thread = 1.259"</i>							
HAND TAP	4	3B	6	17132	17133	\$127.30	\$124.70	\$114.60	\$100.50	\$94.90	\$85.10	\$79.80	
HAND TAP	6	2B	6	17136	17137	\$127.30	\$124.70	\$114.60	\$100.50	\$94.90	\$85.10	\$79.80	
R.H. ROUND DIE 2-1/2"OD				13370		\$194.90	\$167.70	\$157.40	\$133.20	\$127.00	\$116.70	\$103.70	
GAGE - Taperlock Style		2B		23313		\$338.10							
GAGE - Taperlock Style		3B		23314		\$338.10							
GAGE - Ring-Go		2A		23722		\$361.70							
GAGE - Ring-Go		3A		23723		\$361.70							
GAGE - Ring-NoGo		2A		23724		\$361.70							
GAGE - Ring-NoGo		3A		23725		\$361.70							
<b>1 5/16"-20 NS</b>						<i>Recommended Hole Size based on 75% Thread = 1.264"</i>							
HAND TAP	4	3B	6	17140	17141	\$127.30	\$124.70	\$114.60	\$100.50	\$94.90	\$85.10	\$79.80	
GAGE - Taperlock Style		2B		22606		\$271.30							
GAGE - Taperlock Style		3B		22607		\$271.30							
GAGE - Ring-Go		2A		22608		\$317.50							
GAGE - Ring-Go		3A		22609		\$317.50							
GAGE - Ring-NoGo		2A		22610		\$317.50							
GAGE - Ring-NoGo		3A		22611		\$317.50							
<b>1 3/8"-4 ACME</b>						<i>Recommended Hole = 1.1250"</i>							
HAND TAP		2G	4	17144		\$191.70	\$188.90	\$184.10	\$153.40	\$117.20	\$115.50	\$112.90	
L.H. HAND TAP		2G	4	17148		\$191.70	\$188.90	\$184.10	\$153.40	\$117.20	\$115.50	\$112.90	
TANDEM TAP		2G	4	17150		\$349.00	\$317.60	\$307.20	\$296.70	\$287.90	\$261.90	\$240.60	
<b>1 3/8"-6 NC</b>						<i>Recommended Hole Size based on 75% Thread = 1.212"</i>							
L.H. HAND TAP	4	3B	4	17154	17155	\$164.40	\$133.70	\$123.30	\$112.80	\$104.10	\$95.50	\$89.50	
R.H. ROUND DIE 2-1/2"OD				13372		\$194.90	\$167.70	\$157.40	\$133.20	\$127.00	\$116.70	\$103.70	
GAGE - Taperlock Style		2B		23318		\$265.80							
GAGE - Taperlock Style		3B		23319		\$265.80							



Click on Item Number  
for Catalog Listing

SIZE/ DESCRIPTION	GH #	CLASS OF FIT	# FLUTES	ITEM #		1 PC	2 PC	3 PC	6 PC	9 PC	12 PC	24 PC	48 PC
				PLUG	BOTTOM								
<b>1 3/8"-6 NC</b>				<i>See Previous Page for Recommended Hole Size</i>									
GAGE - Ring-Go		2A		23728		\$343.50							
GAGE - Ring-Go		3A		23729		\$343.50							
GAGE - Ring-NoGo		2A		23730		\$343.50							
GAGE - Ring-NoGo		3A		23731		\$343.50							
<b>1 3/8"-8 NS</b>				<i>Recommended Hole Size based on 75% Thread = 1.253"</i>									
<b>HAND TAP</b>	<b>5</b>	<b>3B</b>	<b>4</b>	<b>17158</b>	<b>17159</b>	\$118.10	\$113.00	\$110.40	\$107.50	\$104.10	\$95.50	\$89.50	
R.H. ROUND DIE 2-1/2"OD				13468		\$194.90	\$167.70	\$157.40	\$133.20	\$127.00	\$116.70	\$103.70	
GAGE - Taperlock Style		2B		22618		\$256.50							
GAGE - Taperlock Style		3B		22619		\$256.50							
GAGE - Ring-Go		2A		22620		\$363.60							
GAGE - Ring-Go		3A		22621		\$363.60							
GAGE - Ring-NoGo		2A		22622		\$363.60							
GAGE - Ring-NoGo		3A		22623		\$363.60							
<b>1 3/8"-12 NF</b>				<i>Recommended Hole Size based on 75% Thread = 1.294"</i>									
<b>L.H. HAND TAP</b>	<b>4</b>	<b>3B</b>	<b>6</b>	<b>17166</b>	<b>17167</b>	\$171.70	\$140.60	\$130.20	\$112.90	\$109.40	\$107.70	\$105.10	
<b>CARB-I-SERT TAP</b>	<b>4</b>	<b>3B</b>	<b>4</b>	<b>41573</b>	<b>41574</b>	\$628.90	\$608.70	\$594.00	\$569.60	\$561.00	\$545.60	\$525.40	
R.H. ROUND DIE 2-1/2"OD				13374		\$194.90	\$167.70	\$157.40	\$133.20	\$127.00	\$116.70	\$103.70	
L.H. ROUND DIE 2-1/2"OD				13375		\$194.90	\$167.70	\$157.40	\$133.20	\$127.00	\$116.70	\$103.70	
GAGE - Taperlock Style		2B		23323		\$265.80							
GAGE - Taperlock Style		3B		23324		\$265.80							
GAGE - Ring-Go		2A		23734		\$343.50							
GAGE - Ring-Go		3A		23735		\$343.50							
GAGE - Ring-NoGo		2A		23736		\$343.50							
GAGE - Ring-NoGo		3A		23737		\$343.50							
<b>1 3/8"-16 NS</b>				<i>Recommended Hole Size based on 75% Thread = 1.314"</i>									
<b>HAND TAP</b>	<b>4</b>	<b>3B</b>	<b>6</b>	<b>17170</b>	<b>17171</b>	\$130.90	\$122.50	\$120.50	\$97.40	\$72.70	\$71.00	\$68.40	
R.H. ROUND DIE 2-1/2"OD				13378		\$194.90	\$167.70	\$157.40	\$133.20	\$127.00	\$116.70	\$103.70	
GAGE - Taperlock Style		2B		22630		\$256.50							
GAGE - Taperlock Style		3B		22631		\$256.50							
GAGE - Ring-Go		2A		22632		\$317.50							
GAGE - Ring-Go		3A		22633		\$317.50							
GAGE - Ring-NoGo		2A		22634		\$317.50							
GAGE - Ring-NoGo		3A		22635		\$317.50							
<b>1 3/8"-18 NEF</b>				<i>Recommended Hole Size based on 75% Thread = 1.321"</i>									
<b>HAND TAP</b>	<b>4</b>	<b>3B</b>	<b>6</b>	<b>17174</b>	<b>17175</b>	\$109.50	\$108.90	\$108.40	\$97.40	\$72.70	\$71.00	\$68.40	
<b>HAND TAP</b>	<b>6</b>	<b>2B</b>	<b>6</b>	<b>17178</b>	<b>17179</b>	\$120.10	\$117.70	\$115.30	\$97.40	\$72.70	\$71.00	\$68.40	
R.H. ROUND DIE 2-1/2"OD				13380		\$194.90	\$167.70	\$157.40	\$133.20	\$127.00	\$116.70	\$103.70	
GAGE - Taperlock Style		2B		23328		\$338.10							
GAGE - Taperlock Style		3B		23329		\$338.10							
GAGE - Ring-Go		2A		23740		\$361.70							
GAGE - Ring-Go		3A		23741		\$361.70							
GAGE - Ring-NoGo		2A		23742		\$361.70							
GAGE - Ring-NoGo		3A		23743		\$361.70							
<b>1 3/8"-20 NS</b>				<i>Recommended Hole Size based on 75% Thread = 1.326"</i>									
<b>HAND TAP</b>	<b>4</b>	<b>3B</b>	<b>6</b>	<b>17182</b>	<b>17183</b>	\$162.70	\$130.20	\$120.50	\$97.40	\$72.70	\$71.00	\$68.40	
R.H. ROUND DIE 2-1/2"OD				13382		\$194.90	\$167.70	\$157.40	\$133.20	\$127.00	\$116.70	\$103.70	

TAPS, DIES & GAGES

Click on Item Number for Catalog Listing

SIZE/ DESCRIPTION	GH #	CLASS OF FIT	# FLUTES	ITEM #		1 PC	2 PC	3 PC	6 PC	9 PC	12 PC	24 PC	48 PC
				PLUG	BOTTOM								
<b>1 3/8"-20 NS</b>						<i>See Previous Page for Recommended Hole Size</i>							
GAGE - Taperlock Style		2B		22636		\$271.30							
GAGE - Taperlock Style		3B		22637		\$271.30							
GAGE - Ring-Go		2A		22638		\$318.90							
GAGE - Ring-Go		3A		22639		\$318.90							
GAGE - Ring-NoGo		2A		22640		\$318.90							
GAGE - Ring-NoGo		3A		22641		\$318.90							
<b>1 7/16"-18 NEF</b>						<i>Recommended Hole Size based on 75% Thread = 1.384"</i>							
HAND TAP	4	3B	6	17186	17187	\$111.60	\$111.00	\$110.50	\$99.50	\$74.80	\$73.10	\$70.50	
HAND TAP	6	2B	6	17190	17191	\$111.60	\$111.00	\$110.50	\$99.50	\$74.80	\$73.10	\$70.50	
GAGE - Taperlock Style		2B		23333		\$352.60							
GAGE - Taperlock Style		3B		23334		\$352.60							
GAGE - Ring-Go		2A		23746		\$388.60							
GAGE - Ring-Go		3A		23747		\$388.60							
GAGE - Ring-NoGo		2A		23748		\$388.60							
GAGE - Ring-NoGo		3A		23749		\$388.60							
<b>1 1/2"-4 ACME</b>						<i>Recommended Hole Size = 1.250"</i>							
HAND TAP		2G	4	17194		\$243.60	\$212.30	\$201.80	\$191.40	\$187.80	\$186.20	\$183.60	
L.H. HAND TAP		2G	4	17198		\$243.60	\$212.30	\$201.80	\$191.40	\$187.80	\$186.20	\$183.60	
TANDEM TAP		2G	4	17200		\$403.20	\$376.10	\$340.10	\$322.20	\$316.70	\$310.30	\$303.10	
L.H. TANDEM TAP		2G	4	17201		\$403.20	\$376.10	\$340.10	\$322.20	\$316.70	\$310.30	\$303.10	
<b>1 1/2"-6 NC</b>						<i>Recommended Hole Size Based on 75% Thread = 1.337"</i>							
L.H. HAND TAP	4	3B	4	17204	17205	\$180.60	\$169.30	\$165.10	\$137.60	\$124.80	\$123.20	\$120.50	
10" EXTENSION TAP	4	3B	4	17208	17209	\$328.40	\$319.60	\$303.70	\$265.30	\$210.90	\$201.70	\$199.10	
12" EXTENSION TAP	4	3B	4	17212	17213	\$379.80	\$370.10	\$359.40	\$307.20	\$244.20	\$228.00	\$225.40	
CARB-I-SERT TAP	4	3B	4	41576	41577	\$635.80	\$620.60	\$608.70	\$581.40	\$569.60	\$550.70	\$536.20	
R.H. ROUND DIE 2-1/2"OD				13392		\$194.90	\$167.70	\$157.40	\$133.20	\$127.00	\$116.70	\$103.70	
L.H. ROUND DIE 2-1/2"OD				13393		\$194.90	\$167.70	\$157.40	\$133.20	\$127.00	\$116.70	\$103.70	
GAGE - Taperlock Style		2B		23338		\$291.10							
GAGE - Taperlock Style		3B		23339		\$291.10							
GAGE - Ring-Go		2A		23752		\$367.30							
GAGE - Ring-Go		3A		23753		\$367.30							
GAGE - Ring-NoGo		2A		23754		\$367.30							
GAGE - Ring-NoGo		3A		23755		\$367.30							
<b>1 1/2"-8 NS</b>						<i>Recommended Hole Size based on 75% Thread = 1.378"</i>							
HAND TAP	5	3B	6	17216	17217	\$127.60	\$127.60	\$127.60	\$127.60	\$124.80	\$123.20	\$120.50	
10" EXTENSION TAP	5	3B	4	17220	17221	\$328.40	\$319.60	\$303.70	\$265.30	\$210.90	\$201.70	\$199.10	
12" EXTENSION TAP	5	3B	4	17224	17225	\$379.80	\$370.10	\$359.40	\$307.20	\$244.20	\$228.00	\$225.40	
R.H. ROUND DIE 2-1/2"OD				13470		\$194.90	\$167.70	\$157.40	\$133.20	\$127.00	\$116.70	\$103.70	
GAGE - Taperlock Style		2B		22648		\$271.30							
GAGE - Taperlock Style		3B		22649		\$271.30							
GAGE - Ring-Go		2A		22650		\$339.20							
GAGE - Ring-Go		3A		22651		\$339.20							
GAGE - Ring-NoGo		2A		22652		\$339.20							
GAGE - Ring-NoGo		3A		22653		\$339.20							



Click on Item Number  
for Catalog Listing

SIZE/ DESCRIPTION	GH #	CLASS OF FIT	# FLUTES	ITEM #		1 PC	2 PC	3 PC	6 PC	9 PC	12 PC	24 PC	48 PC
				PLUG	BOTTOM								
<b>1 1/2"-10 NS</b>						<i>Recommended Hole Size based on 75% Thread = 1.402"</i>							
HAND TAP	5	3B	6	17228	17229	\$180.60	\$169.30	\$165.10	\$137.60	\$124.80	\$123.20	\$120.50	
<b>1 1/2"-11 55° WHITWORTH PIPE</b>						<i>Recommended Hole Size: BSPT = 1.750" / BSPP = 1.7656"</i>							
BSPT TAPER - MODIFIED TAP			7	17231	17232	\$183.70	\$183.70	\$183.70	\$183.70	\$183.70	\$183.70	\$183.70	
BSPP PARALLEL - MODIFIED TAP			7	17234	17235	\$183.70	\$183.70	\$183.70	\$183.70	\$183.70	\$183.70	\$183.70	
BSPT TAPER - FULL FORM TAP			7	17939		\$450.40	\$438.00	\$408.90	\$405.10	\$399.60	\$395.20	\$384.00	
BSPP PARALLEL - FULL FORM TAP			7	17930		\$450.40	\$438.00	\$408.90	\$405.10	\$399.60	\$395.20	\$384.00	
GAGE BSPP DBL END w/ handle				27062		\$603.70							
GAGE BSPT w/handle				27023		\$376.70							
<b>1 1/2"-11.5 PIPE NPS NPT/F</b>						<i>Recommended Hole Size: NPT/NPTF = 1.7344" NPS = 1.750" / NPSM = 1.7913"</i>							
NPT/F LEFT HAND TAPER TAP			7	17237		\$259.00	\$222.40	\$209.70	\$185.50	\$146.80	\$144.20	\$141.50	
NPS STRAIGHT TAP			7	17240		\$259.00	\$222.40	\$209.70	\$185.50	\$146.80	\$144.20	\$141.50	
GAGE L1 NPT PLG w/handle				24392		\$173.50							
GAGE L1 NPT RING				24390		\$335.60							
GAGE L1 NPTF PLG w/handle				24482		\$264.00							
GAGE L3 NPTF PLG w/handle				24484		\$264.00							
GAGE NPTF 6 step Plain Plug w/handle				24556		\$295.40							
GAGE L1 NPTF RING				24518		\$350.40							
GAGE L2 NPTF RING				24520		\$470.40							
GAGE NPTF 6 step Plain Ring				24590		\$446.40							
<b>1 1/2"-12 NF</b>						<i>Recommended Hole Size based on 75% Thread = 1.419"</i>							
L.H. HAND TAP	4	3B	6	17244	17245	\$180.60	\$169.30	\$165.10	\$137.60	\$124.80	\$123.20	\$120.50	
HAND TAP	6	2B	6	17248	17249	\$247.80	\$216.50	\$165.10	\$137.60	\$124.80	\$123.20	\$120.50	
R.H. ROUND DIE 2-1/2 "OD				13394		\$194.90	\$167.70	\$157.40	\$133.20	\$127.00	\$116.70	\$103.70	
L.H. ROUND DIE 2-1/2 "OD				13395		\$194.90	\$167.70	\$157.40	\$133.20	\$127.00	\$116.70	\$103.70	
GAGE - Taperlock Style		2B		23343		\$291.10							
GAGE - Taperlock Style		3B		23344		\$291.10							
GAGE - Ring-Go		2A		23758		\$367.30							
GAGE - Ring-Go		3A		23759		\$367.30							
GAGE - Ring-NoGo		2A		23760		\$367.30							
GAGE - Ring-NoGo		3A		23761		\$367.30							
<b>1 1/2"-16 NS</b>						<i>Recommended Hole Size based on 75% Thread = 1.439"</i>							
HAND TAP	4	3B	6	17252	17253	\$172.00	\$137.70	\$96.40	\$92.10	\$88.60	\$86.90	\$84.30	
R.H. ROUND DIE 2-1/2 "OD				13398		\$194.90	\$167.70	\$157.40	\$133.20	\$127.00	\$116.70	\$103.70	
<b>1 1/2"-16 NS</b>						<i>See Previous Page for Recommended Hole Size</i>							
GAGE - Taperlock Style		2B		22660		\$271.30							
GAGE - Taperlock Style		3B		22661		\$271.30							
GAGE - Ring-Go		2A		22662		\$339.20							
GAGE - Ring-Go		3A		22663		\$339.20							
GAGE - Ring-NoGo		2A		22664		\$339.20							
GAGE - Ring-NoGo		3A		22665		\$339.20							
<b>1 1/2"-18 NEF</b>						<i>Recommended Hole Size based on 75% Thread = 1.446"</i>							
HAND TAP	4	3B	6	17256	17257	\$172.00	\$137.70	\$96.40	\$92.10	\$88.60	\$86.90	\$84.30	





TAPS, DIES & GAGES

Click on Item Number for Catalog Listing

SIZE/ DESCRIPTION	GH #	CLASS OF FIT	# FLUTES	ITEM #		1 PC	2 PC	3 PC	6 PC	9 PC	12 PC	24 PC	48 PC
				PLUG	BOTTOM								
<b>1 1/2"-18 NEF</b>						<i>See Previous Page for Recommended Hole Size</i>							
<b>HAND TAP</b>	6	2B	6	17260	17261	\$172.00	\$137.70	\$96.40	\$92.10	\$88.60	\$86.90	\$84.30	
R.H. ROUND DIE 2-1/2" OD				13400		\$194.90	\$167.70	\$157.40	\$133.20	\$127.00	\$116.70	\$103.70	
GAGE - Taperlock Style		2B		23348		\$356.40							
GAGE - Taperlock Style		3B		23349		\$356.40							
GAGE - Ring-Go		2A		23764		\$388.60							
GAGE - Ring-Go		3A		23765		\$388.60							
GAGE - Ring-NoGo		2A		23766		\$388.60							
GAGE - Ring-NoGo		3A		23767		\$388.60							
<b>1 1/2"-20 NS</b>						<i>Recommended Hole Size based on 75% Thread = 1.451"</i>							
<b>HAND TAP</b>	4	3B	6	17264	17265	\$172.00	\$137.70	\$96.40	\$92.10	\$88.60	\$86.90	\$84.30	
R.H. ROUND DIE 2-1/2" OD				13402		\$194.90	\$167.70	\$157.40	\$133.20	\$127.00	\$116.70	\$103.70	
GAGE - Taperlock Style		2B		22666		\$287.60							
GAGE - Taperlock Style		3B		22667		\$287.60							
GAGE - Ring-Go		2A		22668		\$339.20							
GAGE - Ring-Go		3A		22669		\$339.20							
GAGE - Ring-NoGo		2A		22670		\$339.20							
GAGE - Ring-NoGo		3A		22671		\$339.20							
<b>1 1/2"-24 NS</b>						<i>Recommended Hole Size based on 75% Thread = 1.459"</i>							
<b>HAND TAP</b>	4	3B	8	17268	17269	\$194.20	\$155.40	\$108.70	\$96.90	\$93.40	\$91.70	\$89.10	
<b>1 9/16"-16 NS</b>						<i>Recommended Hole Size based on 75% Thread = 1.502"</i>							
<b>HAND TAP</b>	5	3B	6	17272	17273	\$236.30	\$189.10	\$132.30	\$108.80	\$98.60	\$96.80	\$94.30	
<b>1 9/16"-18 NEF</b>						<i>Recommended Hole Size based on 75% Thread = 1.509"</i>							
<b>HAND TAP</b>	5	3B	6	17276	17277	\$169.70	\$167.00	\$132.30	\$108.80	\$101.80	\$96.80	\$94.30	
R.H. ROUND DIE 3" OD				13408		\$286.80	\$278.00	\$268.50	\$224.60	\$214.50	\$196.50	\$181.40	
<b>1 5/8"-5.5 NS</b>						<i>Recommended Hole Size based on 75% Thread = 1.448"</i>							
<b>HAND TAP</b>	7	3B	6	17280	17281	\$249.30	\$199.40	\$139.60	\$128.70	\$124.10	\$122.40	\$119.80	
<b>1 5/8"-8 NS</b>						<i>Recommended Hole Size based on 75% Thread = 1.503"</i>							
<b>HAND TAP</b>	6	3B	6	17284	17285	\$169.50	\$152.50	\$139.60	\$128.70	\$124.10	\$122.40	\$119.80	
<b>1 5/8"-12 NS</b>						<i>Recommended Hole Size based on 75% Thread = 1.544"</i>							
<b>HAND TAP</b>	4	3B	6	17908	17909	\$130.30	\$128.10	\$117.60	\$107.20	\$103.60	\$101.90	\$99.30	
<b>HAND TAP</b>	6	2B	6	17288	17289	\$130.30	\$128.10	\$117.60	\$107.20	\$103.60	\$101.90	\$99.30	
R.H. ROUND DIE 3" OD				13412		\$286.80	\$278.00	\$268.50	\$224.60	\$214.50	\$196.50	\$181.40	
GAGE - Trilock Style		2B		22672		\$309.40							
GAGE - Trilock Style		3B		22673		\$309.40							
GAGE - Ring-Go		2A		22674		\$355.50							
GAGE - Ring-Go		3A		22675		\$355.50							
GAGE - Ring-NoGo		2A		22676		\$355.50							
GAGE - Ring-NoGo		3A		22677		\$355.50							
<b>1 5/8"-16 NS</b>						<i>Recommended Hole Size based on 75% Thread = 1.564"</i>							
<b>HAND TAP</b>	5	3B	6	17292	17293	\$200.50	\$160.50	\$112.40	\$107.20	\$103.60	\$101.90	\$99.30	
R.H. ROUND DIE 3" OD				13414		\$286.80	\$278.00	\$268.50	\$224.60	\$214.50	\$196.50	\$181.40	
<b>1 5/8"-18 NEF</b>						<i>Recommended Hole Size based on 75% Thread = 1.571"</i>							
<b>HAND TAP</b>	5	3B	6	17296	17297	\$200.50	\$160.50	\$112.40	\$107.20	\$103.60	\$101.90	\$99.30	
R.H. ROUND DIE 3" OD				13416		\$286.80	\$278.00	\$268.50	\$224.60	\$214.50	\$196.50	\$181.40	



Click on Item Number for Catalog Listing

SIZE/ DESCRIPTION	GH #	CLASS OF FIT	# FLUTES	ITEM #		1 PC	2 PC	3 PC	6 PC	9 PC	12 PC	24 PC	48 PC
				PLUG	BOTTOM								
<b>1 3/4"-5 NC</b>						<i>Recommended Hole Size based on 75% Thread = 1.555"</i>							
HAND TAP	7	3B	6	17300	17301	\$250.80	\$220.20	\$212.60	\$175.20	\$169.80	\$168.10	\$165.50	
R.H. ROUND DIE 3" OD				13420		\$286.80	\$278.00	\$268.50	\$224.60	\$214.50	\$196.50	\$181.40	
<b>1 3/4"-8 NS</b>						<i>Recommended Hole Size based on 75% Thread = 1.628"</i>							
HAND TAP	6	3B	6	17304	17305	\$192.10	\$186.20	\$180.20	\$175.20	\$169.80	\$168.10	\$165.50	
R.H. ROUND DIE 3" OD				13474		\$286.80	\$278.00	\$268.50	\$224.60	\$214.50	\$196.50	\$181.40	
<b>1 3/4"-10 NS</b>						<i>Recommended Hole Size based on 75% Thread = 1.652"</i>							
HAND TAP	6	3B	6	17308	17309	\$250.20	\$200.20	\$140.20	\$115.10	\$109.70	\$107.30	\$105.10	
<b>1 3/4"-12 NS</b>						<i>Recommended Hole Size based on 75% Thread = 1.669"</i>							
HAND TAP	6	3B	6	17312	17313	\$152.00	\$129.40	\$119.00	\$115.10	\$109.70	\$107.30	\$105.10	
HAND TAP	8	2B	6	17316	17317	\$222.40	\$177.90	\$124.50	\$115.10	\$109.70	\$107.30	\$105.10	
R.H. ROUND DIE 3" OD				13422		\$286.80	\$278.00	\$268.50	\$224.60	\$214.50	\$196.50	\$181.40	
GAGE - Trilock Style		2B		22678		\$324.30							
GAGE - Trilock Style		3B		22679		\$324.30							
GAGE - Ring-Go		2A		22680		\$370.40							
GAGE - Ring-Go		3A		22681		\$370.40							
GAGE - Ring-NoGo		2A		22682		\$370.40							
GAGE - Ring-NoGo		3A		22683		\$370.40							
<b>1 3/4"-16 NS</b>						<i>Recommended Hole Size based on 75% Thread = 1.689"</i>							
HAND TAP	5	3B	6	17320	17321	\$222.40	\$177.90	\$124.50	\$115.10	\$109.70	\$107.30	\$105.10	
HAND TAP	7	2B	6	17324	17325	\$222.40	\$177.90	\$124.50	\$115.10	\$109.70	\$107.30	\$105.10	
R.H. ROUND DIE 3" OD				13426		\$286.80	\$278.00	\$268.50	\$224.60	\$214.50	\$196.50	\$181.40	
<b>1 3/4"-18 NS</b>						<i>Recommended Hole Size based on 75% Thread = 1.696"</i>							
HAND TAP	5	3B	6	17328	17329	\$222.40	\$177.90	\$124.50	\$115.10	\$109.70	\$107.30	\$105.10	
R.H. ROUND DIE 3" OD				13428		\$286.80	\$278.00	\$268.50	\$224.60	\$214.50	\$196.50	\$181.40	
<b>1 7/8"-5 NS</b>						<i>Recommended Hole Size based on 75% Thread = 1.680"</i>							
HAND TAP	7	3B	6	17332	17333	\$284.70	\$227.80	\$173.30	\$162.90	\$159.30	\$157.60	\$155.00	
<b>1 7/8"-8 NS</b>						<i>Recommended Hole Size based on 75% Thread = 1.753"</i>							
HAND TAP	6	3B	6	17336	17337	\$229.10	\$227.80	\$173.30	\$162.90	\$159.30	\$157.60	\$155.00	
R.H. ROUND DIE 3" OD				13476		\$286.80	\$278.00	\$268.50	\$224.60	\$214.50	\$196.50	\$181.40	
<b>1 7/8"-12 NS</b>						<i>Recommended Hole Size based on 75% Thread = 1.794"</i>							
HAND TAP	6	3B	6	17340	17341	\$160.40	\$141.30	\$139.50	\$129.00	\$125.40	\$123.80	\$121.20	
HAND TAP	8	2B	6	17344	17345	\$263.60	\$221.50	\$179.40	\$168.70	\$158.20	\$147.70	\$131.90	
R.H. ROUND DIE 3" OD				13436		\$286.80	\$278.00	\$268.50	\$224.60	\$214.50	\$196.50	\$181.40	
GAGE - Trilock Style		2B		22684		\$339.20							
GAGE - Trilock Style		3B		22685		\$339.20							
GAGE - Ring-Go		2A		22686		\$385.30							
GAGE - Ring-Go		3A		22687		\$385.30							
GAGE - Ring-NoGo		2A		22688		\$385.30							
GAGE - Ring-NoGo		3A		22689		\$385.30							
<b>1 7/8"-16 NS</b>						<i>Recommended Hole Size based on 75% Thread = 1.814"</i>							
HAND TAP	5	3B	6	17348	17349	\$160.40	\$141.30	\$139.50	\$129.00	\$125.40	\$123.80	\$121.20	
R.H. ROUND DIE 3" OD			0	13438		\$286.80	\$278.00	\$268.50	\$224.60	\$214.50	\$196.50	\$181.40	
<b>2"-4.5 NC</b>						<i>Recommended Hole Size based on 75% Thread = 1.783"</i>							
HAND TAP	7	3B	6	17354	17355	\$309.80	\$283.00	\$279.70	\$239.90	\$233.10	\$229.70	\$217.70	
R.H. ROUND DIE 3" OD				13446		\$294.20	\$285.30	\$275.90	\$224.60	\$214.50	\$196.50	\$181.40	

TAPS, DIES & GAGES

Click on Item Number for Catalog Listing

SIZE/DESCRIPTION	GH #	CLASS OF FIT	# FLUTES	ITEM #		1 PC	2 PC	3 PC	6 PC	9 PC	12 PC	24 PC	48 PC
				PLUG	BOTTOM								
<b>2"-8 NS</b>													
Recommended Hole Size based on 75% Thread = 1.878"													
HAND TAP	6	3B	6	17358	17359	\$247.30	\$242.00	\$237.30	\$235.00	\$233.10	\$229.70	\$217.70	
R.H. ROUND DIE 3" OD				13478		\$294.20	\$285.30	\$275.90	\$224.60	\$214.50	\$196.50	\$181.40	
<b>2"-11 55° WHITWORTH PIPE</b>													
Recommended Hole Size: BSPT = 2.2188" / BSPP = 2.250"													
BSPT TAPER - MODIFIED TAP			7	17361	17362	\$259.20	\$255.30	\$248.60	\$238.10	\$234.50	\$232.90	\$230.30	
BSPP PARALLEL - MODIFIED TAP			7	17364	17365	\$259.20	\$255.30	\$248.60	\$238.10	\$234.50	\$232.90	\$230.30	
BSPT TAPER - FULL FORM TAP			7	17940		\$643.70	\$623.10	\$614.40	\$591.20	\$574.20	\$534.40	\$522.70	
BSPP PARALLEL - FULL FORM TAP			7	17931		\$643.70	\$623.10	\$614.40	\$591.20	\$574.20	\$534.40	\$522.70	
<b>2"-11.5 NPS NPT</b>													
Recommended Hole Size: NPSC = 2.2188" / NPSM = 2.2638"													
NPS STRAIGHT TAP			7	17370		\$287.70	\$283.50	\$276.20	\$230.20	\$226.60	\$224.90	\$222.30	
GAGE L1 NPT PLG w/handle				24395		\$208.60							
GAGE L1 NPT RING				24393		\$405.80							
<b>2"-12 NS</b>													
Recommended Hole Size based on 75% Thread = 1.919"													
HAND TAP	6	3B	6	17374	17375	\$178.50	\$171.70	\$169.20	\$166.80	\$163.30	\$161.60	\$159.00	
HAND TAP	8	2B	6	17378	17379	\$207.80	\$199.70	\$193.80	\$166.80	\$163.30	\$161.60	\$159.00	
R.H. ROUND DIE 3"OD				13452		\$294.20	\$285.30	\$275.90	\$224.60	\$214.50	\$196.50	\$181.40	
GAGE - Trilock Style		2B		22690		\$370.40							
GAGE - Trilock Style		3B		22691		\$370.40							
GAGE - Ring-Go		2A		22692		\$407.00							
GAGE - Ring-Go		3A		22693		\$407.00							
GAGE - Ring-NoGo		2A		22694		\$407.00							
GAGE - Ring-NoGo		3A		22695		\$407.00							
<b>2"-16 NS</b>													
Recommended Hole Size based on 75% Thread = 1.939"													
HAND TAP	5	3B	6	17382	17383	\$207.80	\$199.70	\$193.80	\$166.80	\$163.30	\$161.60	\$159.00	
R.H. ROUND DIE 3"OD				13456		\$294.20	\$285.30	\$275.90	\$224.60	\$214.50	\$196.50	\$181.40	
<b>2"-20 NS</b>													
Recommended Hole Size based on 75% Thread = 1.951"													
HAND TAP	5	3B	8	17386	17387	\$207.80	\$199.70	\$193.80	\$166.80	\$163.30	\$161.60	\$159.00	
R.H. ROUND DIE 3"OD				13460		\$294.20	\$285.30	\$275.90	\$224.60	\$214.50	\$196.50	\$181.40	
<b>2 1/8"-8 NS</b>													
Recommended Hole Size based on 75% Thread = 2.003"													
HAND TAP	6	3B	6	17390	17391	\$274.70	\$274.70	\$274.70	\$274.70	\$274.70	\$274.70	\$274.70	
<b>2 1/8"-12 NS</b>													
Recommended Hole Size based on 75% Thread = 2.044"													
HAND TAP	6	3B	6	17394	17395	\$240.00	\$234.70	\$231.40	\$219.70	\$216.50	\$212.70	\$204.10	
<b>2 1/8"-16 NS</b>													
Recommended Hole Size based on 75% Thread = 2.064"													
HAND TAP	5	3B	6	17398	17399	\$240.00	\$234.70	\$231.40	\$219.70	\$216.50	\$212.70	\$204.10	
<b>2 1/4"-4.5 NC</b>													
Recommended Hole Size based on 75% Thread = 2.033"													
HAND TAP	7	3B	6	17402	17403	\$373.10	\$335.80	\$316.20	\$311.00	\$307.80	\$305.70	\$302.10	
<b>2 1/4"-8 NS</b>													
Recommended Hole Size based on 75% Thread = 2.128"													
HAND TAP	6	3B	6	17406	17407	\$299.10	\$299.10	\$299.10	\$299.10	\$299.10	\$299.10	\$299.10	
<b>2 1/4"-12 NS</b>													
Recommended Hole Size based on 75% Thread = .2169"													
HAND TAP	6	3B	6	17410	17411	\$246.60	\$239.40	\$236.30	\$234.00	\$228.60	\$226.90	\$224.30	
GAGE - Trilock Style		2B		22696		\$342.00							
GAGE - Trilock Style		3B		22697		\$342.00							
GAGE - Ring-Go		2A		22698		\$444.90							
GAGE - Ring-Go		3A		22699		\$444.90							



Click on Item Number for Catalog Listing

SIZE/ DESCRIPTION	GH #	CLASS OF FIT	# FLUTES	ITEM #		1 PC	2 PC	3 PC	6 PC	9 PC	12 PC	24 PC	48 PC
				PLUG	BOTTOM								
<b>2 1/4"-12 NS</b>						<i>See Previous Page for Recommended Hole Size</i>							
GAGE - Ring-NoGo		2A		22700		\$444.90							
GAGE - Ring-NoGo		3A		22701		\$444.90							
<b>2 1/4"-16 NS</b>						<i>Recommended Hole Size based on 75% Thread = 2.189"</i>							
HAND TAP	5	3B	6	17414	17415	\$261.30	\$257.30	\$250.80	\$234.00	\$228.60	\$226.90	\$224.30	
<b>2 3/8"-8 NS</b>						<i>Recommended Hole Size based on 75% Thread = 2.253"</i>							
HAND TAP	6	3B	6	17418	17419	\$361.40	\$356.20	\$348.60	\$345.60	\$345.60	\$345.60	\$345.60	
<b>2 3/8"-12 NS</b>						<i>Recommended Hole Size based on 75% Thread = 2.294"</i>							
HAND TAP	6	3B	6	17422	17423	\$305.40	\$294.00	\$267.30	\$239.40	\$235.80	\$234.10	\$231.50	
<b>2 3/8"-16 NS</b>						<i>Recommended Hole Size based on 75% Thread = 2.314"</i>							
HAND TAP	5	3B	6	17426	17427	\$305.40	\$294.00	\$267.30	\$239.40	\$235.80	\$234.10	\$231.50	
<b>2 1/2"-4 NC</b>						<i>Recommended Hole Size based on 75% Thread = 2.256"</i>							
HAND TAP	7	3B	6	17430	17431	\$438.10	\$421.70	\$406.10	\$388.20	\$384.50	\$379.20	\$345.30	
<b>2 1/2"-8 NS</b>						<i>Recommended Hole Size based on 75% Thread = 2.378"</i>							
HAND TAP	6	3B	6	17434	17435	\$438.10	\$421.70	\$406.10	\$388.20	\$384.50	\$379.20	\$345.30	
<b>2 1/2"-8 PIPE TAP NPT/F</b>						<i>Recommended Hole Size: NPT = 2.625" / NPTF = 2.6406"</i>							
NPT/F TAPER TAP			7	17437		\$429.80	\$423.30	\$412.60	\$343.80	\$331.60	\$330.00	\$327.30	
GAGE L1 NPT PLG w/handle				24398		\$286.70							
GAGE L1 NPT RING				24396		\$491.90							
<b>2 1/2"-12 NS</b>						<i>Recommended Hole Size based on 75% Thread = 2.419"</i>							
HAND TAP	6	3B	6	17444	17445	\$305.70	\$294.30	\$263.60	\$244.00	\$240.40	\$238.70	\$236.10	
GAGE - Trilock Style		2B		22702		\$430.10							
GAGE - Trilock Style		3B		22703		\$430.10							
GAGE - Ring-Go		2A		22704		\$460.00							
GAGE - Ring-Go		3A		22705		\$460.00							
GAGE - Ring-NoGo		2A		22706		\$460.00							
GAGE - Ring-NoGo		3A		22707		\$460.00							
<b>2 1/2"-16 NS</b>						<i>Recommended Hole Size based on 75% Thread = 2.439"</i>							
HAND TAP	5	3B	6	17448	17449	\$411.60	\$354.50	\$305.10	\$280.30	\$268.00	\$255.60	\$236.10	
<b>2 3/4"-12 NS</b>						<i>Recommended Hole Size based on 75% Thread = 2.669"</i>							
HAND TAP	7	3B	6	17460	17461	\$362.00	\$348.50	\$318.50	\$301.50	\$298.00	\$296.30	\$293.70	
<b>3"-4 NC</b>						<i>Recommended Hole Size based on 75% Thread = 2.756"</i>							
HAND TAP	9	3B	6	17468	17469	\$647.40	\$575.00	\$512.60					
<b>3"-8 NS</b>						<i>Recommended Hole Size based on 75% Thread = 2.878"</i>							
HAND TAP	8	3B	6	17472	17473	\$647.40	\$575.00	\$512.60					
<b>3"-8 PIPE TAP NPT/F</b>						<i>Recommended Hole Size: NPT/F = 3.265"</i>							
NPT/F TAPER TAP			9	17475		\$739.70	\$648.50	\$611.40					
NPT/F TAPER INT THD TAP			9	17478		\$803.90	\$765.60	\$712.00					
GAGE L1 NPT PLG w/handle				24401		\$334.10							
GAGE L1 NPT RING				24399		\$610.90							
<b>3"-12 NS</b>						<i>Recommended Hole Size based on 75% Thread = 2.919"</i>							
HAND TAP	7	3B	8	17482	17483	\$518.80	\$504.80	\$485.90					
<b>3"-16 NS</b>						<i>Recommended Hole Size based on 75% Thread = 2.939"</i>							
HAND TAP	5	3B	8	17486	17487	\$518.80	\$504.80	\$485.90					

TAPS, DIES & GAGES

Click on Item Number for Catalog Listing

SIZE/ DESCRIPTION	GH #	CLASS OF FIT	# FLUTES	ITEM #		1 PC	2 PC	3 PC	6 PC	9 PC	12 PC	24 PC	48 PC
				PLUG	BOTTOM								
<b>3 1/8"-12 NS</b>													
<i>Recommended Hole Size based on 75% Thread = 3.0442"</i>													
HAND TAP	7	2B	8	17490	17491	\$579.20	\$547.80	\$537.40					
<b>3 1/4"-8 NS</b>													
<i>Recommended Hole Size based on 75% Thread = 3.1281"</i>													
HAND TAP	8	3B	6	17499	17500	\$774.80	\$743.50	\$733.00					
<b>3 1/4"-12 NS</b>													
<i>Recommended Hole Size based on 75% Thread = 3.1692"</i>													
HAND TAP	7	3B	8	17503	17504	\$616.50	\$493.20	\$468.80					
<b>3 1/2"-4 NC</b>													
<i>Recommended Hole Size based on 75% Thread = 3.256"</i>													
HAND TAP	9	3B	6	17507	17508	\$804.90	\$773.60	\$763.10					
<b>3 1/2"-8 NS</b>													
<i>Recommended Hole Size based on 75% Thread = 3.378"</i>													
HAND TAP	8	3B	6	17511	17512	\$804.90	\$773.60	\$763.10					
<b>3 1/2"-8 PIPE TAP NPT/F</b>													
<i>Recommended Hole Size: NPT/F = 3.75"</i>													
NPT/F TAPER TAP			9	17514		\$753.80	\$742.50	\$723.60					
NPT/F TAPER INT THD TAP			9	17517		\$1,055.30	\$953.00	\$860.60					
GAGE L1 NPT PLG w/handle				24404		\$620.30							
GAGE L1 NPT RING				24402		\$956.30							
<b>3 1/2"-12 NS</b>													
<i>Recommended Hole Size based on 75% Thread = 3.4192"</i>													
HAND TAP	7	2B	8	17521	17522	\$561.70	\$505.60	\$459.80					
<b>3 3/4"-4 NC</b>													
<i>Recommended Hole Size based on 75% Thread = 3.506"</i>													
HAND TAP	9	3B	10	17525	17526	\$924.10	\$887.50	\$873.70					
<b>3 3/4"-8 NS</b>													
<i>Recommended Hole Size based on 75% Thread = 3.6281"</i>													
HAND TAP	8	3B	10	17529	17530	\$924.10	\$887.50	\$873.70					
<b>3 3/4"-12 NS</b>													
<i>Recommended Hole Size based on 75% Thread = 3.6692"</i>													
HAND TAP	7	2B	10	17533	17534	\$604.70	\$568.70	\$556.00					
<b>4"-4 NC</b>													
<i>Recommended Hole Size based on 75% Thread = 3.756"</i>													
HAND TAP	9	3B	10	17537	17538	\$1,015.90	\$914.40	\$812.70					
<b>4"-8 NS</b>													
<i>Recommended Hole Size based on 75% Thread = 3.8781"</i>													
HAND TAP	8	3B	10	17541	17542	\$1,015.90	\$914.40	\$812.70					
<b>4"-8 PIPE TAP NPT/F</b>													
<i>Recommended Hole Size: NPT/F = 4.25"</i>													
NPT/F TAPER TAP			9	17544		\$1,039.20	\$920.90	\$897.30					
NPT/F TAPER INT THD TAP			9	17547		\$1,308.50	\$1,288.70	\$1,256.00					
GAGE L1 NPT PLG w/handle				24407		\$692.30							
GAGE L1 NPT RING				24405		\$1,158.70							
<b>4"-12 NS</b>													
<i>Recommended Hole Size based on 75% Thread = 3.9192"</i>													
HAND TAP	7	2B	10	17551	17552	\$715.90	\$644.30	\$591.40					

- The recommended hole sizes shown are reference values, and depending on specific tapping requirements and conditions, may have to be altered. North American Tool Corporation assumes no responsibility or liability of any kind as a result of the selection of tap hole sizes from this catalog.
- Note: For Unified, Metric and Pipe EXTENSION taps, S.T.I. tap and gage sizes, or SPECIAL taps NOT LISTED, please contact our Customer Service Dept.
- FOR QUESTIONS, PLEASE CONTACT OUR CUSTOMER SERVICE DEPT.
- Prices and conditions are subject to change without notice.



Click on Item Number for Catalog Listing

SIZE/ DESCRIPTION	GH #	CLASS OF FIT	# FLUTES	ITEM #		1 PC	2 PC	3 PC	6 PC	9 PC	12 PC	24 PC	48 PC
				PLUG	BOTTOM								
<b>M1.6 X 0.35</b>						<i>Recommended Hole Size based on 75% Thread = 1.25mm</i>							
HAND TAP	3	6H	2	20010		\$22.90	\$21.20	\$19.20	\$17.50	\$16.70	\$16.10	\$15.60	\$14.90
SPIRAL POINT TAP	3	6H		20008		\$24.20	\$23.50	\$21.50	\$19.80	\$19.00	\$18.40	\$17.90	\$17.20
GAGE - Taperlock Style		6H		25003		\$261.30							
GAGE - Reversible Style		6H		25645		\$388.20							
GAGE - Ring-Go		6g		25205		\$334.60							
GAGE - Ring-NoGo		6g		25206		\$334.60							
<b>M1.8 X 0.35</b>						<i>Recommended Hole Size based on 75% Thread = 1.45mm</i>							
HAND TAP	3	6H	2	20022	20023	\$22.30	\$20.50	\$18.50	\$16.90	\$16.00	\$15.50	\$15.00	\$14.30
SPIRAL POINT TAP	3	6H		20020		\$23.60	\$22.80	\$20.80	\$19.20	\$18.30	\$17.80	\$17.30	\$16.60
GAGE - Taperlock Style		6H		25008		\$261.30							
GAGE - Reversible Style		6H		25650		\$388.20							
GAGE - Ring-Go		6g		25210		\$334.60							
GAGE - Ring-NoGo		6g		25211		\$334.60							
<b>M2 X 0.4</b>						<i>Recommended Hole Size based on 75% Thread = 1.6mm</i>							
HAND TAP	3	6H	3	20034	20035	\$22.30	\$20.50	\$18.50	\$16.90	\$16.00	\$15.50	\$15.00	\$14.30
SPIRAL POINT TAP	3	6H	2	20032		\$23.60	\$22.80	\$20.80	\$19.20	\$18.30	\$17.80	\$17.30	\$16.60
GAGE - Taperlock Style		6H		25013		\$177.70							
GAGE - Reversible Style		6H		25655		\$246.40							
GAGE - Ring-Go		6g		25215		\$213.20							
GAGE - Ring-NoGo		6g		25216		\$213.20							
<b>M2.2 X 0.45</b>						<i>Recommended Hole Size based on 75% Thread = 1.75mm</i>							
HAND TAP	3	6H	3	20046	20047	\$17.00	\$15.90	\$14.90	\$13.80	\$13.40	\$12.80	\$12.30	\$11.80
SPIRAL POINT TAP	3	6H	2	20044		\$23.10	\$22.40	\$20.40	\$18.80	\$17.90	\$17.40	\$16.90	\$16.10
GAGE - Taperlock Style		6H		25018		\$177.70							
GAGE - Reversible Style		6H		25660		\$246.40							
GAGE - Ring-Go		6g		25220		\$213.20							
GAGE - Ring-NoGo		6g		25221		\$213.20							
<b>M2.5 X 0.45</b>						<i>Recommended Hole Size based on 75% Thread = 2.05mm</i>							
HAND TAP	3	6H	3	20058	20059	\$21.70	\$20.70	\$16.90	\$14.20	\$12.70	\$12.00	\$10.80	\$9.50
SPIRAL POINT TAP	3	6H	2	20056		\$22.40	\$21.30	\$18.10	\$15.40	\$13.70	\$12.10	\$11.80	\$11.40
HAND TAP	1	4H	3	20052	20053	\$21.70	\$20.70	\$16.90	\$14.20	\$12.70	\$12.00	\$10.80	\$9.50
SPIRAL POINT TAP	1	4H	2	20050		\$22.40	\$21.30	\$18.10	\$15.40	\$13.70	\$12.10	\$11.80	\$11.40
GAGE - Taperlock Style		6H		25023		\$161.10							
GAGE - Reversible Style		6H		25665		\$246.40							
GAGE - Ring-Go		6g		25225		\$213.20							
GAGE - Ring-NoGo		6g		25226		\$213.20							
<b>M2.6 X 0.45</b>						<i>Recommended Hole Size Based on 75% Thread = 2.15mm</i>							
HAND TAP	3	6H	3	21179	21180	\$21.70	\$20.70	\$16.90	\$14.20	\$12.70	\$12.00	\$10.80	\$9.50
<b>M3 X 0.5</b>						<i>Recommended Hole Size Based on 75% Thread = 2.5mm TRU-FLO at 65% Thread = 2.78mm</i>							
HAND TAP	3	6H	3	20070	20071	\$20.00	\$18.80	\$15.60	\$12.90	\$11.40	\$10.90	\$10.50	\$9.20
SPIRAL POINT TAP	3	6H	2	20068		\$21.40	\$20.10	\$17.00	\$14.30	\$12.80	\$11.20	\$10.80	\$9.60
REGULAR SPIRAL FLUTE TAP	3	6H	2	20074	20075	\$22.30	\$19.00	\$17.90	\$15.20	\$13.70	\$13.20	\$12.80	\$11.50
FAST SPIRAL FLUTE TAP	3	6H	2	20078	20079	\$23.70	\$20.30	\$19.30	\$16.60	\$15.10	\$14.60	\$14.20	\$12.90
SPIRAL POINT TAP	5		2	21021		\$32.90	\$30.90	\$28.50	\$27.00	\$23.50	\$21.80	\$19.20	\$16.60
+.076mm SPIRAL POINT TAP	7		2	20938		\$21.40	\$20.10	\$18.10	\$17.20	\$15.80	\$14.40	\$13.70	\$13.10



# TAPS, DIES & GAGES

Click on Item Number for Catalog Listing

SIZE/ DESCRIPTION	GH #	CLASS OF FIT	# FLUTES	ITEM #		1 PC	2 PC	3 PC	6 PC	9 PC	12 PC	24 PC	48 PC
				PLUG	BOTTOM								
<b>M3 X 0.5</b>						<i>See Previous Page for Recommended Hole Size</i>							
HAND TAP	1	4H	3	20064	20065	\$23.10	\$21.90	\$18.80	\$16.00	\$14.60	\$13.00	\$12.70	\$11.30
SPIRAL POINT TAP	1	4H	2	20062		\$23.50	\$22.30	\$19.20	\$16.50	\$14.80	\$13.10	\$12.80	\$12.50
TRU-FLO FORM TAP	5	6H		19200	19201	\$39.10	\$36.50	\$33.10	\$28.70	\$25.10	\$23.50	\$20.80	\$18.20
SOLID CARBIDE / HAND TAP	3	6H	3	43001	43002	\$73.10	\$73.10	\$73.10	\$73.10	\$70.20	\$63.40	\$61.60	\$60.60
SOLID CARBIDE / SP PT TAP	3	6H	2	43003		\$75.50	\$75.50	\$75.50	\$75.50	\$72.60	\$65.00	\$63.20	\$62.20
COST CUTTER DRILL/TAP	3	6H	2	29024		\$15.80	\$15.80	\$15.80	\$15.80	\$15.80	\$15.80	\$15.80	\$15.80
R.H. ROUND DIE 20.6mm OD				13518		\$30.40	\$28.50	\$27.10	\$27.10	\$27.10	\$27.10	\$27.10	\$27.10
GAGE - Taperlock Style		6H		25028		\$161.10							
GAGE - Reversible Style		6H		25670		\$194.30							
GAGE - Ring-Go		6g		25230		\$184.10							
GAGE - Ring-NoGo		6g		25231		\$184.10							
<b>M3.5 X 0.6</b>						<i>Recommended Hole Size Based on 75% Thread = 2.9mm TRU-FLO at 65% Thread = 3.24mm</i>							
HAND TAP	4	6H	3	20091	20092	\$19.30	\$18.00	\$14.90	\$12.20	\$10.70	\$10.10	\$9.70	\$8.70
SPIRAL POINT TAP	4	6H	2	20089		\$20.40	\$19.20	\$16.00	\$13.30	\$11.90	\$11.20	\$10.80	\$9.60
HAND TAP	1	4H	3	20085	20086	\$19.30	\$18.00	\$14.90	\$12.20	\$10.70	\$10.10	\$9.70	\$8.70
SPIRAL POINT TAP	1	4H	2	20083		\$20.40	\$19.20	\$16.00	\$13.30	\$11.90	\$11.20	\$10.80	\$9.60
REGULAR SPIRAL FLUTE TAP	4	6H	2	20101	20102	\$22.30	\$19.00	\$17.90	\$15.20	\$13.70	\$13.20	\$12.80	\$11.50
FAST SPIRAL FLUTE TAP	4	6H	2	20105	20106	\$23.70	\$20.30	\$19.30	\$16.60	\$15.10	\$14.60	\$14.20	\$12.90
6" EXTENSION HAND TAP	4	6H	3	20118	20119	\$40.80	\$38.90	\$35.30	\$28.50	\$24.90	\$23.20	\$20.60	\$18.00
6" EXTENSION SPIRAL POINT TAP	4	6H	2	20116		\$42.00	\$40.10	\$36.40	\$29.60	\$26.10	\$24.40	\$21.80	\$19.20
+.127mm HAND TAP	11	PLATING	3	20112	20113	\$15.90	\$15.70	\$15.30	\$12.80	\$11.90	\$10.90	\$10.60	\$10.00
+.127mm SPIRAL POINT TAP	11	PLATING	2	20110		\$17.10	\$16.90	\$16.50	\$13.90	\$13.00	\$12.10	\$11.80	\$11.10
TRU-FLO FORM TAP	6	6H		19202	19203	\$36.30	\$33.40	\$30.10	\$25.90	\$22.30	\$20.60	\$18.00	\$15.40
SOLID CARBIDE / HAND TAP	4	6H	3	43005	43006	\$73.10	\$73.10	\$73.10	\$73.10	\$70.20	\$63.40	\$61.60	\$60.60
SOLID CARBIDE / SP PT TAP	4	6H	2	43007		\$75.50	\$75.50	\$75.50	\$75.50	\$72.60	\$65.00	\$63.20	\$62.20
COST CUTTER DRILL/TAP	4	6H	2	29025		\$15.30	\$15.30	\$15.30	\$15.30	\$15.30	\$15.30	\$15.30	\$15.30
R.H. ROUND DIE 20.6mm OD				13522		\$30.40	\$28.50	\$27.10	\$27.10	\$27.10	\$27.10	\$27.10	\$27.10
GAGE - Taperlock Style		6H		25033		\$140.10							
GAGE - Reversible Style		6H		25675		\$179.40							
GAGE - Ring-Go		6g		25235		\$184.10							
GAGE - Ring-NoGo		6g		25236		\$184.10							
<b>M4 X 0.75</b>						<i>Recommended Hole Size Based on 75% Thread = 3.25mm</i>							
HAND TAP	4	6H	4	21035	21036	\$18.50	\$17.40	\$16.20	\$15.40	\$15.10	\$14.20	\$13.50	\$12.40
<b>M4 X 0.7</b>						<i>Recommended Hole Size Based on 75% Thread = 3.3mm TRU-FLO at 65% Thread = 3.69mm</i>							
HAND TAP	4	6H	4	20130	20131	\$10.40	\$9.70	\$9.40	\$8.70	\$8.50	\$8.20	\$8.00	\$7.80
SPIRAL POINT TAP	4	6H	2	20128		\$11.50	\$10.80	\$10.50	\$9.90	\$9.70	\$9.40	\$9.10	\$8.90
SPIRAL POINT TAP	5		2	21033		\$20.00	\$19.10	\$18.10	\$17.20	\$16.90	\$15.30	\$14.90	\$14.30
HAND TAP	2	4H	4	20124	20125	\$14.30	\$13.80	\$13.60	\$12.30	\$11.50	\$10.70	\$9.80	\$8.90
SPIRAL POINT TAP	2	4H	2	20122		\$15.40	\$15.00	\$14.80	\$13.40	\$12.70	\$11.90	\$10.90	\$10.10
REGULAR SPIRAL FLUTE TAP	4	6H	2	20140	20141	\$18.90	\$17.90	\$17.00	\$15.60	\$15.10	\$14.60	\$14.10	\$13.50
FAST SPIRAL FLUTE TAP	4	6H	3	20144	20145	\$20.20	\$19.30	\$18.30	\$17.00	\$16.50	\$15.90	\$15.40	\$14.90
+.076mm SPIRAL POINT TAP	7		2	20923		\$18.10	\$17.60	\$17.20	\$16.60	\$16.10	\$15.50	\$15.20	\$14.90
L.H. HAND TAP	4	6H	4	20136	20137	\$10.40	\$9.70	\$9.40	\$8.70	\$8.50	\$8.20	\$8.00	\$7.80
6" EXTENSION HAND TAP	4	6H	4	20157	20158	\$40.80	\$38.90	\$35.30	\$28.50	\$24.90	\$23.20	\$20.60	\$18.00
6" EXTENSION SPIRAL POINT TAP	4	6H	2	20155		\$42.00	\$40.10	\$36.40	\$29.60	\$26.10	\$24.40	\$21.80	\$19.20





Click on Item Number for Catalog Listing

SIZE/ DESCRIPTION	GH #	CLASS OF FIT	# FLUTES	ITEM #		1 PC	2 PC	3 PC	6 PC	9 PC	12 PC	24 PC	48 PC
				PLUG	BOTTOM								
<b>M4 X 0.7</b>						<i>See Previous Page for Recommended Hole Size</i>							
+ .127mm HAND TAP	11	PLATING	4	20151	20152	\$19.30	\$18.30	\$17.40	\$16.00	\$15.50	\$15.00	\$14.50	\$13.70
+ .127mm SPIRAL POINT TAP	11	PLATING	2	20149		\$20.40	\$19.50	\$18.50	\$17.20	\$16.70	\$16.10	\$15.60	\$15.00
TRU-FLO FORM TAP	6	6H		19204	19205	\$36.30	\$33.40	\$30.10	\$25.90	\$22.30	\$20.60	\$18.00	\$15.40
SOLID CARBIDE / HAND TAP	4	6H	4	43009	43010	\$67.70	\$67.70	\$67.70	\$67.70	\$64.70	\$58.50	\$56.70	\$55.60
SOLID CARBIDE / SP PT TAP	4	6H	2	43011		\$70.40	\$70.40	\$70.40	\$70.40	\$67.50	\$61.20	\$59.40	\$58.40
COST CUTTER DRILL/TAP	4	6H	2	29026		\$15.30	\$15.30	\$15.30	\$15.30	\$15.30	\$15.30	\$15.30	\$15.30
R.H. ROUND DIE 20.6mm OD				13524		\$30.40	\$28.50	\$27.10	\$27.10	\$27.10	\$27.10	\$27.10	\$27.10
L.H. ROUND DIE 20.6mm OD				13525		\$57.60	\$50.80	\$47.10	\$43.50	\$41.60	\$37.40	\$27.10	\$27.10
GAGE - Taperlock Style		6H		25038		\$140.10							
GAGE - Reversible Style		6H		25680		\$179.40							
GAGE - Ring-Go		6g		25240		\$171.40							
GAGE - Ring-NoGo		6g		25241		\$171.40							
<b>M4.5 X 0.75</b>						<i>Recommended Hole Size Based on 75% Thread = 3.75mm TRU-FLO at 65% Thread = 4.17mm</i>							
HAND TAP	4	6H	4	20169	20170	\$14.30	\$13.80	\$13.60	\$12.30	\$11.50	\$10.70	\$9.80	\$8.90
SPIRAL POINT TAP	4	6H	2	20167		\$15.40	\$15.00	\$14.80	\$13.40	\$12.70	\$11.90	\$10.90	\$10.10
HAND TAP	2	4H	4	20163	20164	\$14.30	\$13.80	\$13.60	\$12.30	\$11.50	\$10.70	\$9.80	\$8.90
SPIRAL POINT TAP	2	4H	2	20161		\$15.40	\$15.00	\$14.80	\$13.40	\$12.70	\$11.90	\$10.90	\$10.10
REGULAR SPIRAL FLUTE TAP	4	6H	2	20179	20180	\$18.90	\$17.90	\$17.00	\$15.60	\$15.10	\$14.60	\$14.10	\$13.50
FAST SPIRAL FLUTE TAP	4	6H	3	20183	20184	\$20.20	\$19.30	\$18.30	\$17.00	\$16.50	\$15.90	\$15.40	\$14.90
L.H. HAND TAP	4	6H	4	20175	20176	\$14.30	\$13.80	\$13.60	\$12.30	\$11.50	\$10.70	\$9.80	\$8.90
6" EXTENSION HAND TAP	4	6H	4	20196	20197	\$35.60	\$34.40	\$33.20	\$30.90	\$29.10	\$27.40	\$24.80	\$22.20
6" EXTENSION SPIRAL POINT TAP	4	6H	2	20194		\$36.70	\$35.60	\$34.30	\$32.00	\$30.30	\$28.60	\$26.00	\$23.40
+ .127mm HAND TAP	11	PLATING	4	20190	20191	\$19.30	\$18.30	\$17.40	\$16.00	\$15.50	\$15.00	\$14.50	\$13.70
+ .127mm SPIRAL POINT TAP	11	PLATING	2	20188		\$20.40	\$19.50	\$18.50	\$17.20	\$16.70	\$16.10	\$15.60	\$15.00
TRU-FLO FORM TAP	6	6H		19206	19207	\$36.30	\$33.40	\$30.10	\$25.90	\$22.30	\$20.60	\$18.00	\$15.40
SOLID CARBIDE / HAND TAP	4	6H	4	43013	43014	\$67.70	\$67.70	\$67.70	\$67.70	\$64.70	\$58.50	\$56.70	\$55.60
SOLID CARBIDE / SP PT TAP	4	6H	2	43015		\$70.40	\$70.40	\$70.40	\$70.40	\$67.50	\$61.20	\$59.40	\$58.40
COST CUTTER DRILL/TAP	4	6H	2	29027		\$15.30	\$15.30	\$15.30	\$15.30	\$15.30	\$15.30	\$15.30	\$15.30
R.H. ROUND DIE 20.6mm OD				13528		\$30.40	\$28.50	\$27.10	\$27.10	\$27.10	\$27.10	\$27.10	\$27.10
GAGE - Taperlock Style		6H		25043		\$140.10							
GAGE - Reversible Style		6H		25685		\$179.40							
GAGE - Ring-Go		6g		25245		\$171.40							
GAGE - Ring-NoGo		6g		25246		\$171.40							
<b>M5 X 0.9</b>						<i>Recommended Hole Size Based on 75% Thread = 4.1mm</i>							
HAND TAP	3	4H	4	21184	21185	\$27.30	\$24.40	\$23.10	\$22.20	\$17.30	\$15.90	\$13.90	\$10.80
SPIRAL POINT TAP	3	4H	2	21186		\$28.50	\$25.50	\$24.30	\$23.40	\$18.40	\$17.90	\$15.80	\$15.20
<b>M5 X 0.8</b>						<i>Recommended Hole Size Based on 75% Thread = 4.2mm TRU-FLO at 65% Thread = 4.65mm</i>							
HAND TAP	4	6H	4	20208	20209	\$12.20	\$11.00	\$9.90	\$8.90	\$8.60	\$8.30	\$7.90	\$7.70
SPIRAL POINT TAP	4	6H	2	20206		\$12.20	\$11.00	\$9.90	\$8.90	\$8.60	\$8.30	\$7.90	\$7.70
HAND TAP	2	4H	4	20202	20203	\$27.30	\$24.40	\$23.10	\$22.20	\$17.30	\$15.90	\$13.90	\$10.80
SPIRAL POINT TAP	2	4H	2	20200		\$28.50	\$25.50	\$24.30	\$23.40	\$18.40	\$17.90	\$15.80	\$15.20
REGULAR SPIRAL FLUTE TAP	4	6H	2	20218	20219	\$18.90	\$17.90	\$17.00	\$15.60	\$15.10	\$14.60	\$14.10	\$13.50
FAST SPIRAL FLUTE TAP	4	6H	3	20222	20223	\$20.20	\$19.30	\$18.30	\$17.90	\$17.50	\$16.40	\$16.00	\$15.20
+ .076mm SPIRAL POINT TAP	7		2	20924		\$20.30	\$19.80	\$19.40	\$19.00	\$18.70	\$18.10	\$17.10	\$16.80

TAPS, DIES & GAGES

Click on Item Number for Catalog Listing

SIZE/ DESCRIPTION	GH #	CLASS OF FIT	# FLUTES	ITEM #		1 PC	2 PC	3 PC	6 PC	9 PC	12 PC	24 PC	48 PC
				PLUG	BOTTOM								
<b>M5 X 0.8</b>						<i>See Previous Page for Recommended Hole Size</i>							
L.H. HAND TAP	4	6H	4	20214	20215	\$12.20	\$11.00	\$9.90	\$8.90	\$8.60	\$8.30	\$7.90	\$7.70
6" EXTENSION HAND TAP	4	6H	4	20235	20236	\$35.60	\$34.40	\$33.20	\$30.90	\$29.10	\$27.40	\$24.80	\$22.20
6" EXTENSION SPIRAL POINT TAP	4	6H	2	20233		\$36.70	\$35.60	\$34.30	\$32.00	\$30.30	\$28.60	\$26.00	\$23.40
+.127mm HAND TAP	11	PLATING	4	20229	20230	\$19.10	\$18.30	\$17.40	\$16.00	\$15.50	\$15.00	\$14.50	\$13.70
+.127mm SPIRAL POINT TAP	11	PLATING	2	20227		\$19.20	\$18.50	\$18.00	\$17.80	\$17.40	\$16.20	\$15.10	\$13.90
TRU-FLO FORM TAP	7	6H		19208	19209	\$36.30	\$33.40	\$30.10	\$25.90	\$22.30	\$20.60	\$18.00	\$15.40
SOLID CARBIDE / HAND TAP	4	6H	4	43017	43018	\$70.40	\$70.40	\$70.40	\$70.40	\$67.50	\$61.20	\$59.40	\$58.40
SOLID CARBIDE / SP PT TAP	4	6H	2	43019		\$73.10	\$73.10	\$73.10	\$73.10	\$70.20	\$63.90	\$62.10	\$61.10
COST CUTTER DRILL/TAP	4	6H	2	29028		\$15.30	\$15.30	\$15.30	\$15.30	\$15.30	\$15.30	\$15.30	\$15.30
TiN COAT / +.076mm SP PT TAP	7		2	55009		\$23.40	\$22.80	\$22.40	\$22.00	\$21.70	\$21.20	\$20.10	\$19.80
R.H. ROUND DIE 20.6mm OD				13530		\$30.40	\$28.50	\$27.10	\$27.10	\$27.10	\$27.10	\$27.10	\$27.10
L.H. ROUND DIE 20.6mm OD				13531		\$57.60	\$50.80	\$47.10	\$43.50	\$41.60	\$37.40	\$27.10	\$27.10
GAGE - Taperlock Style		6H		25048		\$140.10							
GAGE - Reversible Style		6H		25690		\$179.40							
GAGE - Ring-Go		6g		25250		\$171.40							
GAGE - Ring-NoGo		6g		25251		\$171.40							
<b>M5 X 0.5</b>						<i>Recommended Hole Size Based on 75% Thread = 4.5mm</i>							
HAND TAP	3	6H	4	20910	20911	\$16.80	\$16.50	\$16.10	\$15.80	\$15.40	\$14.70	\$14.20	\$13.60
SPIRAL POINT TAP	3	6H	2	20912		\$26.50	\$25.30	\$24.20	\$22.70	\$21.40	\$18.10	\$16.00	\$15.20
GAGE - Taperlock Style		6H		22780		\$236.20							
GAGE - Reversible Style		6H		22781		\$298.50							
GAGE - Ring-Go		6g		22782		\$351.40							
GAGE - Ring-NoGo		6g		22783		\$351.40							
<b>M5.5 X 0.9</b>						<i>Recommended Hole Size Based on 75% Thread = 4.6mm</i>							
HAND TAP	3	4H	4	21189	21190	\$35.60	\$34.80	\$31.90	\$26.70	\$19.50	\$18.00	\$14.30	\$13.30
SPIRAL POINT TAP	3	4H	2	21191		\$36.70	\$36.00	\$33.10	\$27.80	\$20.60	\$19.20	\$15.40	\$14.50
<b>M6 X 1.0</b>						<i>Recommended Hole Size Based on 75% Thread = 5mm TRU-FLO at 65% Thread = 5.56mm</i>							
HAND TAP	5	6H	4	20247	20248	\$8.10	\$8.10	\$8.10	\$8.10	\$8.10	\$7.40	\$7.40	\$7.40
SPIRAL POINT TAP	5	6H	2	20245		\$8.90	\$8.90	\$8.90	\$8.90	\$8.90	\$8.40	\$8.40	\$8.40
HAND TAP	3	4H	4	20241	20242	\$19.40	\$18.30	\$17.70	\$14.90	\$11.10	\$9.40	\$8.90	\$7.80
SPIRAL POINT TAP	3	4H	2	20239		\$28.50	\$25.50	\$24.30	\$16.00	\$13.40	\$12.10	\$11.30	\$10.90
REGULAR SPIRAL FLUTE TAP	5	6H	3	20257	20258	\$19.20	\$18.30	\$17.50	\$15.80	\$15.60	\$15.40	\$15.30	\$14.80
FAST SPIRAL FLUTE TAP	5	6H	3	20261	20262	\$20.40	\$19.60	\$18.80	\$17.10	\$16.90	\$16.70	\$16.60	\$16.40
L.H. HAND TAP	5	6H	4	20253	20254	\$9.50	\$9.50	\$9.50	\$9.50	\$9.50	\$8.80	\$8.80	\$8.80
6" EXTENSION HAND TAP	5	6H	4	20274	20275	\$35.60	\$34.40	\$33.20	\$30.90	\$29.10	\$27.40	\$24.80	\$22.20
6" EXTENSION SPIRAL POINT TAP	5	6H	2	20272		\$36.70	\$35.60	\$34.30	\$32.00	\$30.30	\$28.60	\$26.00	\$23.40
+.127mm HAND TAP	11	PLATING	4	20268	20269	\$10.40	\$10.10	\$9.80	\$9.60	\$9.60	\$8.80	\$8.80	\$8.10
+.127mm SPIRAL POINT TAP	11	PLATING	2	20266		\$11.40	\$11.10	\$10.80	\$10.60	\$10.40	\$9.70	\$9.70	\$9.20
TRU-FLO FORM TAP	8	6H		19210	19211	\$39.00	\$35.10	\$32.90	\$28.60	\$25.00	\$23.40	\$20.70	\$18.10
SOLID CARBIDE / HAND TAP	5	6H	4	43021	43022	\$69.30	\$69.30	\$69.30	\$69.30	\$69.30	\$66.50	\$65.20	\$64.50
SOLID CARBIDE / SP PT TAP	5	6H	2	43023		\$71.70	\$71.70	\$71.70	\$71.70	\$71.70	\$67.10	\$65.70	\$65.00
COST CUTTER DRILL/TAP	5	6H	2	29029		\$15.30	\$15.30	\$15.30	\$15.30	\$15.30	\$15.30	\$15.30	\$15.30
R.H. ROUND DIE 25.4mm OD				13538		\$38.20	\$34.00	\$32.50	\$30.60	\$30.60	\$30.60	\$30.60	\$30.40
L.H. ROUND DIE 25.4mm OD				13539		\$57.60	\$50.80	\$47.10	\$43.50	\$41.60	\$37.40	\$30.60	\$30.40



Click on Item Number for Catalog Listing

SIZE/ DESCRIPTION	GH #	CLASS OF FIT	# FLUTES	ITEM #		1 PC	2 PC	3 PC	6 PC	9 PC	12 PC	24 PC	48 PC
				PLUG	BOTTOM								
<b>M6 X 1.0</b>						<i>See Previous Page for Recommended Hole Size</i>							
GAGE - Taperlock Style		6H		25053		\$97.90							
GAGE - Reversible Style		6H		25695		\$126.60							
GAGE - Ring-Go		6g		25255		\$126.60							
GAGE - Ring-NoGo		6g		25256		\$126.60							
<b>M6 X 0.75</b>						<i>Recommended Hole Size Based on 75% Thread = 5.25mm</i>							
HAND TAP	3	4H	4	20280	20281	\$18.30	\$17.10	\$14.60	\$12.00	\$11.60	\$10.40	\$9.50	\$8.90
SPIRAL POINT TAP	3	4H	2	20278		\$19.60	\$19.20	\$17.50	\$13.80	\$12.40	\$11.80	\$10.90	\$10.50
R.H. ROUND DIE 25.4mm OD				13536		\$57.60	\$50.80	\$47.10	\$35.50	\$34.20	\$30.60	\$27.10	\$27.10
GAGE - Taperlock Style		6H		22792		\$222.40							
GAGE - Reversible Style		6H		22793		\$268.70							
GAGE - Ring-Go		6g		22794		\$298.50							
GAGE - Ring-NoGo		6g		22795		\$298.50							
<b>M6 X 0.5</b>						<i>Recommended Hole Size Based on 75% Thread = 5.5mm</i>							
HAND TAP	3	6H	4	20976	20977	\$20.40	\$19.60	\$18.80	\$17.10	\$16.90	\$16.70	\$16.60	\$16.40
TiN COAT / BTM TAP	3	6H	4		55011	\$23.50	\$22.60	\$21.80	\$20.10	\$19.90	\$19.70	\$19.60	\$19.40
<b>M7 X 1.0</b>						<i>Recommended Hole Size Based on 75% Thread = 6mm TRU-FLO at 65% Thread = 6.56mm</i>							
HAND TAP	5	6H	4	20290	20291	\$13.90	\$13.20	\$12.30	\$11.90	\$11.90	\$11.90	\$11.90	\$11.90
SPIRAL POINT TAP	5	6H	2	20288		\$14.30	\$13.50	\$12.60	\$12.20	\$12.20	\$12.20	\$12.20	\$12.20
L.H. HAND TAP	5	6H	4	20295	20296	\$13.90	\$13.20	\$12.30	\$11.90	\$11.90	\$11.90	\$11.90	\$11.90
+.127mm HAND TAP	11	PLATING	4	20309	20310	\$13.90	\$13.20	\$12.30	\$11.90	\$11.90	\$11.90	\$11.90	\$11.90
+.127mm SPIRAL POINT TAP	11	PLATING	2	20307		\$14.30	\$13.50	\$12.60	\$12.20	\$12.20	\$12.20	\$12.20	\$12.20
TRU-FLO FORM TAP	8	6H		19212	19213	\$42.00	\$38.00	\$35.80	\$31.50	\$28.00	\$26.30	\$23.70	\$21.10
SOLID CARBIDE / HAND TAP	5	6H	4	43025	43026	\$91.00	\$91.00	\$91.00	\$91.00	\$91.00	\$88.80	\$87.10	\$78.70
SOLID CARBIDE / SP PT TAP	5	6H	2	43027		\$93.40	\$93.40	\$93.40	\$93.40	\$93.40	\$90.40	\$88.70	\$80.30
COST CUTTER DRILL/TAP	5	6H	2	29030		\$23.10	\$23.10	\$23.10	\$23.10	\$23.10	\$23.10	\$23.10	\$23.10
R.H. ROUND DIE 25.4mm OD				13542		\$57.60	\$50.80	\$47.10	\$43.50	\$41.60	\$37.40	\$30.60	\$30.40
L.H. ROUND DIE 25.4mm OD				13543		\$57.60	\$50.80	\$47.10	\$43.50	\$41.60	\$37.40	\$30.60	\$30.40
GAGE - Taperlock Style		6H		25058		\$96.00							
GAGE - Reversible Style		6H		25700		\$126.60							
GAGE - Ring-Go		6g		25260		\$126.60							
GAGE - Ring-NoGo		6g		25261		\$126.60							
<b>M8 X 1.25</b>						<i>Recommended Hole Size Based on 75% Thread = 6.75mm TRU-FLO at 65% Thread = 7.45mm</i>							
HAND TAP	5	6H	4	20324	20325	\$10.30	\$10.10	\$9.90	\$9.10	\$9.10	\$9.10	\$9.10	\$9.10
SPIRAL POINT TAP	5	6H	2	20322		\$14.30	\$13.50	\$12.60	\$12.20	\$12.20	\$12.20	\$12.20	\$12.20
HAND TAP	3	4H	4	20319	20320	\$20.10	\$19.00	\$16.10	\$12.90	\$12.30	\$11.40	\$10.40	\$8.60
SPIRAL POINT TAP	3	4H	2	20317		\$22.10	\$21.70	\$21.20	\$17.60	\$15.90	\$13.30	\$12.40	\$12.20
REGULAR SPIRAL FLUTE TAP	5	6H	3	20333	20334	\$23.60	\$22.80	\$21.10	\$19.80	\$19.30	\$18.40	\$17.70	\$17.20
FAST SPIRAL FLUTE TAP	5	6H	3	20337	20338	\$24.40	\$23.70	\$21.90	\$20.70	\$20.10	\$19.30	\$18.50	\$18.00
L.H. HAND TAP	5	6H	4	20329	20330	\$11.30	\$10.90	\$10.60	\$9.90	\$9.90	\$9.90	\$9.90	\$9.50
6" EXTENSION HAND TAP	5	6H	4	20348	20349	\$37.30	\$35.90	\$35.10	\$33.60	\$33.10	\$31.40	\$28.80	\$26.20
6" EXTENSION SPIRAL POINT TAP	5	6H	2	21022		\$38.60	\$37.30	\$36.40	\$35.00	\$34.40	\$32.80	\$30.10	\$27.50
+.127mm HAND TAP	11	PLATING	4	20343	20344	\$12.90	\$12.20	\$11.80	\$10.80	\$10.80	\$10.80	\$10.80	\$10.80
+.127mm SPIRAL POINT TAP	11	PLATING	2	20341		\$14.30	\$13.50	\$13.10	\$12.20	\$12.20	\$12.20	\$12.20	\$12.20
TRU-FLO FORM TAP	9	6H		19214	19215	\$42.00	\$38.00	\$35.80	\$31.50	\$28.00	\$26.30	\$23.70	\$21.10

TAPS, DIES & GAGES

Click on Item Number for Catalog Listing

SIZE/ DESCRIPTION	GH #	CLASS OF FIT	# FLUTES	ITEM #		1 PC	2 PC	3 PC	6 PC	9 PC	12 PC	24 PC	48 PC
				PLUG	BOTTOM								
<b>M8 X 1.25</b>						<i>See Previous Page for Recommended Hole Size</i>							
SOLID CARBIDE / HAND TAP	5	6H	4	43029	43030	\$91.00	\$91.00	\$91.00	\$91.00	\$91.00	\$88.80	\$87.10	\$78.70
SOLID CARBIDE / SP PT TAP	5	6H	2	43031		\$93.40	\$93.40	\$93.40	\$93.40	\$93.40	\$90.40	\$88.70	\$80.30
COST CUTTER DRILL/TAP	5	6H	2	29031		\$23.10	\$23.10	\$23.10	\$23.10	\$23.10	\$23.10	\$23.10	\$23.10
TiN COAT / PLUG TAP	5	6H	4	55002		\$14.90	\$14.70	\$14.50	\$13.70	\$13.70	\$13.70	\$13.70	\$13.70
TiN COAT / SP PT TAP	5	6H	2	55001		\$18.90	\$18.10	\$17.20	\$16.80	\$16.80	\$16.80	\$16.80	\$16.80
R.H. ROUND DIE 25.4mm OD				13546		\$40.20	\$34.20	\$32.20	\$30.60	\$30.60	\$30.60	\$30.60	\$30.40
L.H. ROUND DIE 25.4mm OD				13547		\$57.60	\$50.80	\$47.10	\$43.50	\$41.60	\$37.40	\$30.60	\$30.40
GAGE - Taperlock Style		6H		25063		\$96.00							
GAGE - Reversible Style		6H		25705		\$128.50							
GAGE - Ring-Go		6g		25265		\$126.60							
GAGE - Ring-NoGo		6g		25266		\$126.60							
<b>M8 X 1.0</b>						<i>Recommended Hole Size Based on 75% Thread = 7mm TRU-FLO at 65% Thread = 7.56mm</i>							
HAND TAP	5	6H	4	20358	20359	\$11.50	\$10.80	\$9.90	\$9.40	\$8.90	\$8.90	\$8.90	\$8.90
SPIRAL POINT TAP	5	6H	2	20356		\$12.90	\$12.20	\$11.20	\$9.80	\$9.80	\$9.80	\$9.80	\$9.80
HAND TAP	3	4H	4	20353	20354	\$17.80	\$17.50	\$17.10	\$14.10	\$12.30	\$12.00	\$11.10	\$10.40
SPIRAL POINT TAP	3	4H	2	20351		\$19.20	\$18.90	\$18.40	\$15.40	\$13.60	\$13.30	\$12.50	\$12.20
L.H. HAND TAP	5	6H	4	20363	20364	\$17.80	\$17.50	\$17.10	\$14.10	\$12.30	\$12.00	\$11.10	\$10.40
+.127mm HAND TAP	11	PLATING	4	20376	20377	\$17.80	\$17.50	\$17.10	\$14.10	\$12.30	\$12.00	\$11.10	\$10.40
+.127mm SPIRAL POINT TAP	11	PLATING	2	20374		\$19.20	\$18.90	\$18.40	\$15.40	\$13.60	\$13.30	\$12.50	\$12.20
REGULAR SPIRAL FLUTE TAP	5	6H	3	20367	20368	\$25.70	\$24.20	\$22.80	\$20.70	\$20.70	\$20.70	\$20.70	\$19.50
FAST SPIRAL FLUTE TAP	5	6H	3	20371	20372	\$26.60	\$25.10	\$23.80	\$21.60	\$21.60	\$21.60	\$21.60	\$20.20
TRU-FLO FORM TAP	8	6H		19216	19217	\$42.00	\$38.00	\$35.80	\$31.50	\$28.00	\$26.30	\$23.70	\$21.10
SOLID CARBIDE / HAND TAP	5	6H	4	43033	43034	\$91.00	\$91.00	\$91.00	\$91.00	\$91.00	\$88.80	\$87.10	\$78.70
R.H. ROUND DIE 25.4mm OD				13548		\$57.60	\$50.80	\$47.10	\$43.50	\$41.60	\$37.40	\$30.60	\$30.40
L.H. ROUND DIE 25.4mm OD				13549		\$57.60	\$50.80	\$47.10	\$43.50	\$41.60	\$37.40	\$30.60	\$30.40
GAGE - Taperlock Style		6H		25068		\$96.00							
GAGE - Reversible Style		6H		25710		\$128.50							
GAGE - Ring-Go		6g		25270		\$126.60							
GAGE - Ring-NoGo		6g		25271		\$126.60							
<b>M8 X 0.75</b>						<i>Recommended Hole Size Based on 75% Thread = 7.25mm</i>							
HAND TAP	5	6H	4	20941	20942	\$29.40	\$28.10	\$26.80	\$24.20	\$23.20	\$21.60	\$18.00	\$16.40
GAGE - Taperlock Style		6H		22820		\$237.50							
GAGE - Reversible Style		6H		22821		\$299.90							
GAGE - Ring-Go		6g		22822		\$321.50							
GAGE - Ring-NoGo		6g		22823		\$321.50							
<b>M8 X 0.5</b>						<i>Recommended Hole Size Based on 75% Thread = 7.5mm</i>							
HAND TAP	4	6H	4	21024	21025	\$30.80	\$28.40	\$26.60	\$25.00	\$24.70	\$23.00	\$18.30	\$17.80
<b>M9 X 1.25</b>						<i>Recommended Hole Size Based on 75% Thread = 7.75mm</i>							
HAND TAP	5	6H	4	21038	21039	\$31.00	\$30.50	\$29.70	\$24.80	\$23.90	\$22.20	\$19.60	\$17.00
GAGE - Taperlock Style		6H		22832		\$118.10							
GAGE - Reversible Style		6H		22833		\$135.70							
GAGE - Ring-Go		6g		22834		\$268.70							
GAGE - Ring-NoGo		6g		22835		\$268.70							
<b>M9 X 1.0</b>						<i>Recommended Hole Size Based on 75% Thread = 8mm</i>							
HAND TAP	5	6H		21041	21042	\$31.00	\$30.50	\$29.70	\$24.80	\$23.90	\$22.20	\$19.60	\$17.00



Click on Item Number for Catalog Listing

SIZE/ DESCRIPTION	GH #	CLASS OF FIT	# FLUTES	ITEM #		1 PC	2 PC	3 PC	6 PC	9 PC	12 PC	24 PC	48 PC
				PLUG	BOTTOM								
<b>M9 X 1.0</b>						<i>See Previous Page for Recommended Hole Size</i>							
GAGE - Taperlock Style		6H		22844		\$192.60							
GAGE - Reversible Style		6H		22845		\$240.20							
GAGE - Ring-Go		6g		22846		\$253.70							
GAGE - Ring-NoGo		6g		22847		\$253.70							
<b>M10 X 1.5</b>						<i>Recommended Hole Size Based on 75% Thread = 8.5mm TRU-FLO at 65% Thread = 9.34mm</i>							
HAND TAP	6	6H	4	20391	20392	\$17.50	\$16.90	\$16.20	\$15.30	\$15.30	\$15.30	\$15.30	\$14.30
SPIRAL POINT TAP	6	6H	3	20389		\$19.30	\$18.70	\$18.00	\$17.10	\$17.10	\$17.10	\$17.10	\$15.80
HAND TAP	3	4H	4	20386	20387	\$30.90	\$30.50	\$29.60	\$23.10	\$18.70	\$15.50	\$14.90	\$13.00
SPIRAL POINT TAP	3	4H	3	20384		\$31.90	\$31.30	\$24.20	\$22.20	\$20.60	\$19.20	\$18.20	\$16.50
+ .076 SPIRAL POINT TAP	7		3	21043		\$31.90	\$31.50	\$30.80	\$26.40	\$25.50	\$24.70	\$22.10	\$19.50
REGULAR SPIRAL FLUTE TAP	6	6H	3	20400	20401	\$33.40	\$30.10	\$29.00	\$26.20	\$26.20	\$26.20	\$26.20	\$21.70
FAST SPIRAL FLUTE TAP	6	6H	3	20404	20405	\$34.40	\$32.30	\$31.10	\$28.30	\$28.30	\$28.30	\$28.30	\$23.80
L.H. HAND TAP	6	6H	4	20396	20397	\$20.30	\$19.70	\$19.00	\$17.90	\$17.90	\$17.90	\$17.90	\$15.10
6" EXTENSION HAND .323 SHK TAP	6	6H	4	21194	21195	\$34.60	\$34.10	\$33.30	\$31.10	\$30.60	\$29.20	\$27.80	\$27.00
6" EXTENSION SP PT .323 SHK TAP	6	6H	3	21196		\$36.30	\$35.50	\$34.60	\$32.40	\$31.90	\$30.60	\$29.20	\$28.40
6" EXTENSION HAND TAP	6	6H	4	20415	20416	\$34.60	\$34.10	\$33.30	\$31.10	\$30.60	\$29.20	\$27.80	\$27.00
6" EXTENSION SPIRAL POINT TAP	6	6H	3	21026		\$36.10	\$35.60	\$34.70	\$32.50	\$32.00	\$30.70	\$29.30	\$28.50
+ .127mm HAND TAP	11	PLATING	4	20410	20411	\$21.90	\$19.30	\$18.50	\$17.40	\$17.40	\$17.40	\$17.40	\$15.50
+ .127mm SPIRAL POINT TAP	11	PLATING	3	20408		\$23.20	\$20.60	\$20.00	\$18.80	\$18.80	\$18.80	\$18.80	\$16.50
TRU-FLO FORM TAP	10	6H		19218	19219	\$43.80	\$39.90	\$37.70	\$33.40	\$29.80	\$28.20	\$25.50	\$22.90
SOLID CARBIDE / HAND TAP	6	6H	4	43037	43038	\$113.50	\$102.30	\$96.70	\$91.00	\$88.70	\$85.30	\$82.00	\$79.60
SOLID CARBIDE / SP PT TAP	6	6H	3	43039		\$117.10	\$105.70	\$100.20	\$92.60	\$90.30	\$87.00	\$83.50	\$81.20
COST CUTTER DRILL/TAP	6	6H	2	29032		\$27.80	\$27.80	\$27.80	\$27.80	\$27.80	\$27.80	\$27.80	\$27.80
TiN COAT / SP PT x 6" TAP	6	6H	3	55012		\$43.40	\$42.90	\$42.10	\$39.90	\$39.30	\$38.00	\$36.60	\$35.80
R.H. ROUND DIE 25.4mm OD				13556		\$40.20	\$34.20	\$32.20	\$30.60	\$30.60	\$30.60	\$30.60	\$30.40
L.H. ROUND DIE 38.1mm OD				13557		\$70.90	\$60.50	\$56.90	\$40.60	\$38.80	\$35.50	\$30.60	\$30.40
GAGE - Taperlock Style		6H		25073		\$99.60							
GAGE - Reversible Style		6H		25715		\$128.50							
GAGE - Ring-Go		6g		25275		\$137.50							
GAGE - Ring-NoGo		6g		25276		\$137.50							
<b>M10 X 1.25</b>						<i>Recommended Hole Size Based on 75% Thread = 8.75mm TRU-FLO at 65% Thread = 9.45mm</i>							
HAND TAP	3	4H	4	20420	20421	\$31.30	\$30.10	\$24.70	\$20.40	\$19.10	\$17.80	\$17.10	\$15.20
SPIRAL POINT TAP	3	4H	3	20418		\$32.70	\$31.50	\$26.10	\$21.80	\$20.10	\$19.20	\$18.20	\$16.50
HAND TAP	5	6H	4	20425	20426	\$18.30	\$17.80	\$17.20	\$16.00	\$16.00	\$16.00	\$16.00	\$15.50
SPIRAL POINT TAP	5	6H	3	20423		\$18.90	\$18.20	\$17.70	\$16.90	\$16.90	\$16.90	\$16.90	\$16.50
REGULAR SPIRAL FLUTE TAP	5	6H	3	20434	20435	\$33.60	\$31.40	\$30.10	\$26.20	\$26.20	\$26.20	\$26.20	\$21.70
FAST SPIRAL FLUTE TAP	5	6H	3	20438	20439	\$35.70	\$33.50	\$32.20	\$28.30	\$28.30	\$28.30	\$28.30	\$23.80
L.H. HAND TAP	5	6H	4	20430	20431	\$20.20	\$19.70	\$19.00	\$17.90	\$17.90	\$17.90	\$17.90	\$15.10
+ .127mm HAND TAP	11	PLATING	4	20443	20444	\$21.90	\$19.30	\$18.50	\$17.40	\$17.40	\$17.40	\$17.40	\$15.50
+ .127mm SPIRAL POINT TAP	11	PLATING	3	20441		\$23.20	\$20.60	\$20.00	\$18.80	\$18.80	\$18.80	\$18.80	\$16.50
TRU-FLO FORM TAP	9	6H		19220	19221	\$43.80	\$39.90	\$37.70	\$33.40	\$29.80	\$28.20	\$25.50	\$22.90
SOLID CARBIDE HAND TAP	5	6H	4	43041	43042	\$113.50	\$102.30	\$96.70	\$91.00	\$88.70	\$85.30	\$82.00	\$79.60
SOLID CARBIDE SP PT TAP	5	6H	3	43043		\$117.10	\$105.70	\$100.20	\$92.60	\$90.30	\$87.00	\$83.50	\$81.20

TAPS, DIES & GAGES

Click on Item Number for Catalog Listing

SIZE/ DESCRIPTION	GH #	CLASS OF FIT	# FLUTES	ITEM #		1 PC	2 PC	3 PC	6 PC	9 PC	12 PC	24 PC	48 PC
				PLUG	BOTTOM								
<b>M10 X 1.25</b>						<i>See Previous Page for Recommended Hole Size</i>							
TiN COAT / SP PT TAP	5	6H	3	55003		\$23.50	\$22.80	\$22.30	\$21.50	\$21.50	\$21.50	\$21.50	\$21.10
R.H. ROUND DIE 38.1mm OD				13558		\$74.50	\$66.30	\$62.50	\$58.90	\$56.50	\$51.40	\$47.50	\$47.10
L.H. ROUND DIE 38.1mm OD				13559		\$74.50	\$66.30	\$62.50	\$58.90	\$56.50	\$51.40	\$47.50	\$47.10
GAGE - Taperlock Style		6H		25078		\$99.60							
GAGE - Reversible Style		6H		25720		\$128.50							
GAGE - Ring-Go		6g		25150		\$137.50							
GAGE - Ring-NoGo		6g		25151		\$137.50							
<b>M10 X 1.0</b>						<i>Recommended Hole Size Based on 75% Thread = 9mm</i>							
SPARK PL HAND TAP	3		4	20448	20449	\$19.00	\$18.00	\$17.20	\$15.50	\$15.50	\$15.50	\$15.50	\$15.10
HAND TAP	5	6H	4	20945	20946	\$19.00	\$18.00	\$17.20	\$16.20	\$15.70	\$15.20	\$14.70	\$14.20
L.H. HAND TAP	5	6H	4	20949	20950	\$31.90	\$31.50	\$30.80	\$25.50	\$24.90	\$23.80	\$22.60	\$21.10
SPIRAL POINT TAP	5	6H	3	20978		\$31.90	\$31.50	\$30.80	\$25.50	\$19.20	\$18.00	\$17.20	\$16.20
R.H. ROUND DIE 38.1mm OD				13554		\$74.50	\$63.50	\$59.70	\$58.90	\$56.50	\$51.40	\$47.40	\$47.10
GAGE - Taperlock Style		6H		22864		\$103.20							
GAGE - Reversible Style		6H		22865		\$253.70							
GAGE - Ring-Go		6g		22866		\$138.50							
GAGE - Ring-NoGo		6g		22867		\$138.50							
<b>M11 X 1.5</b>						<i>Recommended Hole Size Based on 75% Thread = 9.5mm</i>							
HAND TAP	6	6H	4	20453	20454	\$36.40	\$33.40	\$27.80	\$21.10	\$20.40	\$19.50	\$18.70	\$18.00
SPIRAL POINT TAP	6	6H	3	20451		\$37.90	\$34.80	\$29.30	\$22.50	\$21.80	\$20.80	\$20.10	\$19.50
R.H. ROUND DIE 38.1mm OD				13560		\$74.50	\$66.30	\$62.50	\$58.90	\$56.50	\$51.40	\$47.50	\$47.10
GAGE - Taperlock Style		6H		22876		\$118.10							
GAGE - Reversible Style		6H		22877		\$153.40							
GAGE - Ring-Go		6g		22878		\$149.30							
GAGE - Ring-NoGo		6g		22879		\$149.30							
<b>M11 X 1.0</b>						<i>Recommended Hole Size Based on 75% Thread = 10mm</i>							
HAND TAP	5	6H	4	20985	20986	\$36.40	\$33.90	\$31.00	\$29.40	\$27.60	\$24.80	\$22.20	\$21.80
GAGE - Taperlock Style		6H		22888		\$207.70							
GAGE - Reversible Style		6H		22889		\$256.50							
GAGE - Ring-Go		6g		22890		\$271.30							
GAGE - Ring-NoGo		6g		22891		\$271.30							
<b>M12 X 1.75</b>						<i>Recommended Hole Size Based on 75% Thread = 10.25mm TRU-FLO at 65% Thread = 11.23mm</i>							
HAND TAP	6	6H	4	20463	20464	\$19.00	\$18.20	\$17.60	\$17.00	\$17.00	\$17.00	\$17.00	\$16.50
SPIRAL POINT TAP	6	6H	3	20461		\$21.10	\$20.20	\$19.50	\$18.20	\$18.20	\$18.20	\$18.20	\$18.00
HAND TAP	3	4H	4	20458	20459	\$31.20	\$30.80	\$29.80	\$24.60	\$22.30	\$21.10	\$20.10	\$19.80
SPIRAL POINT TAP	3	4H	3	20456		\$33.30	\$32.90	\$31.90	\$26.70	\$23.80	\$22.30	\$21.50	\$21.20
REGULAR SPIRAL FLUTE TAP	6	6H	3	20472	20473	\$39.30	\$37.90	\$36.50	\$34.40	\$34.40	\$34.40	\$34.40	\$29.00
FAST SPIRAL FLUTE TAP	6	6H	3	20476	20477	\$41.70	\$40.30	\$39.10	\$36.60	\$36.60	\$36.60	\$36.60	\$31.40
L.H. HAND TAP	6	6H	4	20468	20469	\$23.80	\$23.10	\$22.30	\$19.10	\$19.10	\$19.10	\$19.10	\$18.50
6" EXTENSION HAND TAP	6	6H	4	20487	20488	\$38.00	\$37.30	\$36.20	\$35.00	\$34.10	\$33.10	\$32.20	\$31.50
6" EXTENSION SP PT TAP	6	6H	3	20913		\$41.40	\$40.30	\$39.10	\$38.00	\$36.80	\$35.70	\$35.30	\$34.70
+.127mm HAND TAP	11	PLATING	4	20482	20483	\$23.70	\$22.70	\$21.90	\$20.90	\$20.00	\$17.60	\$17.20	\$16.80
+.127mm SPIRAL POINT TAP	11	PLATING	3	20480		\$25.20	\$24.30	\$23.50	\$22.50	\$21.60	\$19.20	\$18.80	\$18.30
TRU-FLO FORM TAP	11	6H		19222	19223	\$49.70	\$45.70	\$43.50	\$39.20	\$35.70	\$34.00	\$31.90	\$28.80
SOLID CARBIDE / HAND TAP	6	6H	4	43045	43046	\$172.30	\$172.30	\$172.30	\$166.60	\$151.10	\$148.60	\$138.80	\$137.50
SOLID CARBIDE / SP PT TAP	6	6H	3	43047		\$175.80	\$175.80	\$175.80	\$168.30	\$152.60	\$150.20	\$140.50	\$139.00





Click on Item Number for Catalog Listing

SIZE/ DESCRIPTION	GH #	CLASS OF FIT	# FLUTES	ITEM #		1 PC	2 PC	3 PC	6 PC	9 PC	12 PC	24 PC	48 PC
				PLUG	BOTTOM								
<b>M12 X 1.75</b>				<i>See Previous Page for Recommended Hole Size</i>									
COST CUTTER DRILL/TAP	6	6H	2	29033		\$37.90	\$37.90	\$37.90	\$37.90	\$37.90	\$37.90	\$37.90	\$37.90
TiN COAT / SP PT x 6" TAP	6	6H	3	55008		\$48.70	\$47.60	\$46.40	\$45.30	\$44.10	\$43.00	\$42.60	\$42.10
R.H. ROUND DIE 38.1mm OD				13564		\$65.80	\$55.90	\$52.70	\$47.50	\$47.50	\$47.50	\$47.50	\$47.10
L.H. ROUND DIE 38.1mm OD				13565		\$74.50	\$66.30	\$62.50	\$58.90	\$56.50	\$51.40	\$47.50	\$47.10
GAGE - Taperlock Style		6H		25083		\$106.60							
GAGE - Reversible Style		6H		25725		\$142.90							
GAGE - Ring-Go		6g		25280		\$146.60							
GAGE - Ring-NoGo		6g		25281		\$146.60							
<b>M12 X 1.5</b>				<i>Recommended Hole Size Based on 75% Thread = 10.50mm</i>									
HAND TAP	6	6H	4	20906	20907	\$30.10	\$29.70	\$28.90	\$24.10	\$23.60	\$22.90	\$22.30	\$21.70
SPIRAL POINT TAP	6	6H	3	21027		\$33.30	\$32.90	\$31.90	\$26.70	\$25.10	\$23.50	\$20.80	\$18.20
TiN COAT / SP PT TAP	6	6H	3	55013		\$37.90	\$37.50	\$36.50	\$31.30	\$29.70	\$28.10	\$25.40	\$22.80
GAGE - Taperlock Style		6H		22900		\$97.80							
GAGE - Reversible Style		6H		22901		\$133.10							
GAGE - Ring-Go		6g		22902		\$141.10							
GAGE - Ring-NoGo		6g		22903		\$141.10							
<b>M12 X 1.25</b>				<i>Recommended Hole Size Based on 75% Thread = 10.75mm TRU-FLO at 65% Thread = 11.45mm</i>									
HAND TAP	5	6H	4	20497	20498	\$21.90	\$21.20	\$20.30	\$19.90	\$19.90	\$19.90	\$19.90	\$19.60
SPIRAL POINT TAP	5	6H	3	20495		\$23.50	\$22.70	\$21.90	\$21.50	\$21.50	\$21.50	\$21.50	\$21.20
HAND TAP	3	4H	4	20492	20493	\$31.20	\$30.80	\$29.80	\$24.60	\$22.30	\$21.10	\$20.10	\$19.80
SPIRAL POINT TAP	3	4H	3	20490		\$33.30	\$32.90	\$31.90	\$26.70	\$23.80	\$22.30	\$21.50	\$21.20
REGULAR SPIRAL FLUTE TAP	5	6H	3	20506	20507	\$39.30	\$37.90	\$36.50	\$34.40	\$34.40	\$34.40	\$34.40	\$29.00
FAST SPIRAL FLUTE TAP	5	6H	3	20510	20511	\$41.70	\$40.30	\$39.10	\$36.60	\$36.60	\$36.60	\$36.60	\$31.40
L.H. HAND TAP	5	6H	4	20502	20503	\$23.00	\$22.30	\$21.50	\$21.10	\$21.10	\$21.10	\$21.10	\$20.70
+ .127mm HAND TAP	11	PLATING	4	20515	20516	\$23.70	\$22.70	\$21.90	\$20.90	\$20.00	\$17.60	\$17.20	\$16.80
TRU-FLO FORM TAP	10	6H		19224	19225	\$49.70	\$45.70	\$43.50	\$39.20	\$35.70	\$34.00	\$31.90	\$28.80
TiN COAT / REG SPIRAL FLT TAP	5	6H	3	55004		\$43.90	\$42.50	\$41.10	\$39.00	\$39.00	\$39.00	\$39.00	\$33.60
R.H. ROUND DIE 38.1mm OD				13566		\$74.50	\$66.30	\$62.50	\$58.90	\$56.50	\$51.40	\$47.50	\$47.10
L.H. ROUND DIE 38.1mm OD				13567		\$74.50	\$66.30	\$62.50	\$58.90	\$56.50	\$51.40	\$47.50	\$47.10
GAGE - Taperlock Style		6H		25088		\$106.60							
GAGE - Reversible Style		6H		25730		\$142.90							
GAGE - Ring-Go		6g		25285		\$146.60							
GAGE - Ring-NoGo		6g		25286		\$146.60							
<b>M12 X 1.0</b>				<i>Recommended Hole Size Based on 75% Thread = 11mm</i>									
HAND TAP	5	6H	4	20890	20891	\$30.10	\$29.70	\$28.90	\$24.10	\$23.60	\$22.90	\$22.30	\$21.70
SPIRAL POINT TAP	5	6H	3	20914		\$36.80	\$36.30	\$35.50	\$34.50	\$31.00	\$29.30	\$26.70	\$25.80
GAGE - Taperlock Style		6H		22920		\$207.70							
GAGE - Reversible Style		6H		22921		\$271.30							
GAGE - Ring-Go		6g		22922		\$271.30							
GAGE - Ring-NoGo		6g		22923		\$271.30							
<b>M14 X 2.0</b>				<i>Recommended Hole Size Based on 75% Thread = 12mm TRU-FLO at 65% Thread = 13.13mm</i>									
HAND TAP	7	6H	4	20530	20531	\$31.20	\$30.30	\$29.20	\$28.40	\$27.80	\$26.20	\$23.60	\$20.90
SPIRAL POINT TAP	7	6H	3	20528		\$33.80	\$32.90	\$31.80	\$31.00	\$30.50	\$28.80	\$26.20	\$23.60
HAND TAP	3	4H	4	20525	20526	\$44.50	\$43.70	\$41.80	\$31.40	\$27.80	\$26.20	\$23.60	\$20.90
SPIRAL POINT TAP	3	4H	3	20523		\$47.10	\$46.30	\$44.50	\$34.00	\$30.50	\$28.80	\$26.20	\$23.60



TAPS, DIES & GAGES

Click on Item Number for Catalog Listing

SIZE/ DESCRIPTION	GH #	CLASS OF FIT	# FLUTES	ITEM #		1 PC	2 PC	3 PC	6 PC	9 PC	12 PC	24 PC	48 PC
				PLUG	BOTTOM								
<b>M14 X 2.0</b>						<i>See Previous Page for Recommended Hole Size</i>							
L.H. HAND TAP	7	6H	4	20535	20536	\$32.30	\$31.40	\$30.40	\$29.50	\$29.00	\$27.30	\$24.70	\$22.10
TRU-FLO FORM TAP	12	6H		19226	19227	\$53.20	\$49.30	\$47.10	\$42.80	\$39.20	\$37.60	\$35.50	\$32.30
R.H. ROUND DIE 38.1mm OD				13570		\$62.50	\$57.70	\$55.00	\$51.40	\$51.40	\$51.40	\$47.50	\$47.10
L.H. ROUND DIE 38.1mm OD				13571		\$74.50	\$66.30	\$62.50	\$58.90	\$56.50	\$51.40	\$47.50	\$47.10
GAGE - Taperlock Style		6H		25093		\$132.10							
GAGE - Reversible Style		6H		25735		\$162.90							
GAGE - Ring-Go		6g		25290		\$162.90							
GAGE - Ring-NoGo		6g		25291		\$162.90							
<b>M14 X 1.5</b>						<i>Recommended Hole Size Based on 75% Thread = 12.5mm TRU-FLO at 65% Thread = 13.34mm</i>							
HAND TAP	6	6H	4	20546	20547	\$31.20	\$30.30	\$29.20	\$28.40	\$27.80	\$27.30	\$26.90	\$26.10
SPIRAL POINT TAP	6	6H	3	20543		\$33.80	\$32.90	\$31.80	\$31.00	\$30.50	\$29.90	\$29.50	\$28.70
HAND TAP	3	4H	4	20540	20541	\$44.50	\$43.70	\$41.80	\$31.40	\$27.80	\$26.20	\$23.60	\$20.90
SPIRAL POINT TAP	3	4H	3	20538		\$47.10	\$46.30	\$44.50	\$34.00	\$30.50	\$28.80	\$26.20	\$23.60
L.H. HAND TAP	6	6H	4	20551	20552	\$32.30	\$31.40	\$30.40	\$29.50	\$29.00	\$28.50	\$28.10	\$27.20
TRU-FLO FORM TAP	11	6H		19228	19229	\$53.20	\$49.30	\$47.10	\$42.80	\$39.20	\$37.60	\$35.50	\$32.30
R.H. ROUND DIE 38.1mm OD				13572		\$74.50	\$66.30	\$62.50	\$58.90	\$56.50	\$51.40	\$47.50	\$47.10
L.H. ROUND DIE 38.1mm OD				13573		\$74.50	\$66.30	\$62.50	\$58.90	\$56.50	\$51.40	\$47.50	\$47.10
GAGE - Taperlock Style		6H		25098		\$132.10							
GAGE - Reversible Style		6H		25740		\$162.90							
GAGE - Ring-Go		6g		25295		\$162.90							
GAGE - Ring-NoGo		6g		25296		\$162.90							
<b>M14 X 1.25</b>						<i>Recommended Hole Size Based on 75% Thread = 12.75mm</i>							
SPARK PL HAND TAP	4		4	20556	20557	\$31.20	\$30.30	\$29.20	\$28.40	\$27.80	\$27.30	\$26.90	\$26.10
R.H. ROUND DIE 38.1mm OD				13568		\$74.50	\$66.30	\$62.50	\$58.90	\$56.50	\$51.40	\$47.50	\$47.10
GAGE - Taperlock Style		6H		22940		\$192.60							
GAGE - Reversible Style		6H		22941		\$248.20							
GAGE - Ring-Go		6g		22942		\$268.70							
GAGE - Ring-NoGo		6g		22943		\$268.70							
<b>M14 X 1.0</b>						<i>Recommended Hole Size Based on 75% Thread = 13mm</i>							
HAND TAP	5	6H	4	20902	20903	\$41.50	\$40.90	\$39.90	\$33.30	\$32.20	\$31.90	\$28.40	\$27.10
GAGE - Taperlock Style		6H		22944		\$207.70							
GAGE - Ring-Go		6g		22946		\$268.70							
GAGE - Ring-NoGo		6g		22947		\$268.70							
<b>M15 X 1.0</b>						<i>Recommended Hole Size Based on 75% Thread = 14mm</i>							
HAND TAP	5	6H	4	20989	20990	\$49.60	\$48.90	\$47.60	\$42.10	\$39.70	\$37.60	\$35.40	\$34.30
GAGE - Taperlock Style		6H		22948		\$112.60							
GAGE - Reversible Style		6H		22949		\$158.80							
GAGE - Ring-Go		6g		22950		\$211.10							
GAGE - Ring-NoGo		6g		22951		\$211.10							
<b>M16 X 2.0</b>						<i>Recommended Hole Size Based on 75% Thread = 14mm TRU-FLO at 65% Thread = 15.13mm</i>							
HAND TAP	7	6H	4	20566	20567	\$41.60	\$38.00	\$35.50	\$34.50	\$31.90	\$30.30	\$27.60	\$25.00
SPIRAL POINT TAP	7	6H	3	20564		\$44.00	\$40.40	\$37.90	\$36.90	\$34.30	\$32.70	\$30.00	\$27.40
HAND TAP	4	4H	4	20561	20562	\$53.90	\$50.40	\$46.40	\$36.00	\$31.90	\$30.30	\$27.60	\$25.00
SPIRAL POINT TAP	4	4H	3	20559		\$56.30	\$52.80	\$48.90	\$38.40	\$34.30	\$32.70	\$30.00	\$27.40



Click on Item Number for Catalog Listing

SIZE/ DESCRIPTION	GH #	CLASS OF FIT	# FLUTES	ITEM #		1 PC	2 PC	3 PC	6 PC	9 PC	12 PC	24 PC	48 PC
				PLUG	BOTTOM								
<b>M16 X 2.0</b>						<i>See Previous Page for Recommended Hole Size</i>							
L.H. HAND TAP	7	6H	4	20571	20572	\$42.80	\$39.10	\$36.90	\$35.70	\$35.30	\$33.90	\$33.30	\$31.70
6" EXTENSION HAND TAP	7	6H	4	20953	20954	\$70.10	\$61.70	\$53.30	\$48.10	\$44.60	\$42.90	\$40.30	\$37.70
6" EXTENSION SPIRAL POINT TAP	7	6H	3	21028		\$72.80	\$64.40	\$56.10	\$50.80	\$47.30	\$45.60	\$43.00	\$40.40
TRU-FLO FORM TAP	14	6H		19230	19231	\$57.90	\$54.00	\$51.80	\$47.50	\$43.90	\$42.30	\$40.20	\$37.00
TiN COAT / HAND TAP x 6" TAP	7	6H	4	55010		\$81.60	\$73.20	\$64.80	\$59.60	\$56.10	\$54.40	\$51.80	\$49.20
+ .127mm HAND TAP	11	PLATING	4	20576	20577	\$41.60	\$40.20	\$36.70	\$36.00	\$34.50	\$33.60	\$33.00	\$32.00
+ .127mm SPIRAL POINT TAP	11	PLATING	3	20574		\$44.00	\$42.60	\$39.10	\$38.40	\$36.90	\$36.00	\$35.40	\$34.40
R.H. ROUND DIE 38.1mm OD				13576		\$65.80	\$55.90	\$52.70	\$51.40	\$51.40	\$51.40	\$47.50	\$47.10
L.H. ROUND DIE 38.1mm OD				13577		\$74.50	\$66.30	\$62.50	\$58.90	\$56.50	\$51.40	\$47.50	\$47.10
GAGE - Taperlock Style		6H		25103		\$132.10							
GAGE - Reversible Style		6H		25745		\$162.90							
GAGE - Ring-Go		6g		25300		\$162.90							
GAGE - Ring-NoGo		6g		25301		\$162.90							
<b>M16 X 1.5</b>						<i>Recommended Hole Size Based on 75% Thread = 14.5mm</i>							
HAND TAP	6	6H	4	20586	20587	\$41.60	\$38.00	\$35.50	\$34.50	\$33.90	\$33.60	\$33.00	\$32.00
SPIRAL POINT TAP	6	6H	3	20584		\$44.00	\$42.60	\$39.10	\$38.40	\$36.90	\$36.00	\$35.40	\$34.40
HAND TAP	3	4H	4	20581	20582	\$53.90	\$50.40	\$46.40	\$36.00	\$31.90	\$30.30	\$27.60	\$25.00
SPIRAL POINT TAP	3	4H	3	20579		\$56.30	\$52.80	\$48.90	\$38.40	\$34.30	\$32.70	\$30.00	\$27.40
L.H. HAND TAP	6	6H	4	20591	20592	\$42.80	\$39.10	\$36.90	\$35.70	\$35.40	\$34.70	\$34.10	\$33.20
R.H. ROUND DIE 38.1mm OD				13578		\$74.50	\$66.30	\$62.50	\$58.90	\$56.50	\$51.40	\$47.50	\$47.10
L.H. ROUND DIE 38.1mm OD				13579		\$74.50	\$66.30	\$62.50	\$58.90	\$56.50	\$51.40	\$47.50	\$47.10
GAGE - Taperlock Style		6H		25108		\$132.10							
GAGE - Reversible Style		6H		25750		\$162.90							
GAGE - Ring-Go		6g		25305		\$162.90							
GAGE - Ring-NoGo		6g		25306		\$162.90							
<b>M16 X 1.0</b>						<i>Recommended Hole Size Based on 75% Thread = 15mm</i>							
HAND TAP	5	6H	4	21045	21046	\$49.60	\$48.90	\$47.60	\$44.40	\$40.80	\$39.10	\$35.10	\$33.90
GAGE - Taperlock Style		6H		22976		\$222.50							
GAGE - Reversible Style		6H		22977		\$278.10							
GAGE - Ring-Go		6g		22978		\$298.50							
GAGE - Ring-NoGo		6g		22979		\$298.50							
<b>M18 X 2.5</b>						<i>Recommended Hole Size Based on 75% Thread = 15.5mm</i>							
HAND TAP	7	6H	4	20601	20602	\$50.30	\$44.40	\$42.40	\$40.30	\$36.90	\$35.30	\$32.70	\$30.00
SPIRAL POINT TAP	7	6H	3	20599		\$56.60	\$50.60	\$48.60	\$44.00	\$40.60	\$38.90	\$36.30	\$33.70
L.H. HAND TAP	7	6H	4	20606	20607	\$52.40	\$46.40	\$44.50	\$42.40	\$39.00	\$37.40	\$34.70	\$32.10
R.H. ROUND DIE 38.1mm OD				13584		\$74.50	\$66.30	\$62.50	\$58.90	\$56.50	\$51.40	\$47.50	\$47.10
L.H. ROUND DIE 38.1mm OD				13585		\$74.50	\$66.30	\$62.50	\$58.90	\$56.50	\$51.40	\$47.50	\$47.10
GAGE - Taperlock Style		6H		25113		\$150.30							
GAGE - Reversible Style		6H		25755		\$188.10							
GAGE - Ring-Go		6g		25310		\$211.80							
GAGE - Ring-NoGo		6g		25311		\$211.80							
<b>M18 X 1.5</b>						<i>Recommended Hole Size Based on 75% Thread = 16.5mm TRU-FLO at 65% Thread = 17.34mm</i>							
HAND TAP	6	6H	4	20621	20622	\$46.10	\$44.40	\$42.40	\$40.30	\$36.90	\$35.30	\$33.30	\$32.10
SPARK PL HAND TAP	4		4	20616	20617	\$50.30	\$44.40	\$42.40	\$40.30	\$36.90	\$35.30	\$33.30	\$32.10

TAPS, DIES & GAGES

Click on Item Number for Catalog Listing

SIZE/ DESCRIPTION	GH #	CLASS OF FIT	# FLUTES	ITEM #		1 PC	2 PC	3 PC	6 PC	9 PC	12 PC	24 PC	48 PC
				PLUG	BOTTOM								
<b>M18 X 1.5</b>						<i>See Previous Page for Recommended Hole Size</i>							
HAND TAP	3	4H	4	20611	20612	\$50.30	\$44.40	\$42.40	\$40.30	\$36.90	\$35.30	\$33.30	\$32.10
L.H. HAND TAP	6	6H	4	20626	20627	\$50.90	\$46.40	\$44.50	\$42.40	\$39.00	\$37.40	\$34.70	\$32.10
TRU-FLO FORM TAP	12	6H		19232	19233	\$63.40	\$59.40	\$57.20	\$52.90	\$49.40	\$47.70	\$45.60	\$42.50
R.H. ROUND DIE 38.1mm OD				13586		\$74.50	\$66.30	\$62.50	\$58.90	\$56.50	\$51.40	\$47.50	\$47.10
GAGE - Taperlock Style		6H		25118		\$150.30							
GAGE - Reversible Style		6H		25760		\$188.10							
GAGE - Ring-Go		6g		25315		\$211.80							
GAGE - Ring-NoGo		6g		25316		\$211.80							
<b>M18 X 1.0</b>						<i>Recommended Hole Size Based on 75% Thread = 17mm</i>							
HAND TAP	5	6H	4	20894	20895	\$72.40	\$70.90	\$59.50	\$54.30	\$39.80	\$32.70	\$32.00	\$30.90
GAGE - Taperlock Style		6H		22988		\$222.50							
GAGE - Reversible Style		6H		22989		\$279.60							
GAGE - Ring-Go		6g		22990		\$298.50							
GAGE - Ring-NoGo		6g		22991		\$298.50							
<b>M20 X 2.5</b>						<i>Recommended Hole Size Based on 75% Thread = 17.5mm</i>							
HAND TAP	7	6H	4	20636	20637	\$53.20	\$51.90	\$49.80	\$47.30	\$46.60	\$45.30	\$44.40	\$43.20
SPIRAL POINT TAP	7	6H	3	20634		\$58.70	\$57.30	\$55.20	\$52.70	\$52.00	\$50.70	\$49.80	\$48.60
HAND TAP	4	4H	4	20631	20632	\$84.80	\$69.10	\$65.20	\$62.60	\$46.60	\$43.40	\$40.80	\$38.20
FAST SPIRAL FLUTE TAP	7	6H	4	21051	21052	\$173.90	\$144.50	\$115.40	\$96.90	\$83.80	\$73.90	\$69.10	\$66.00
L.H. HAND TAP	7	6H	4	20641	20642	\$62.60	\$60.30	\$57.10	\$53.70	\$50.10	\$48.40	\$45.80	\$43.40
6" EXTENSION HAND TAP TAP	7	6H	4	20933	20934	\$93.30	\$91.50	\$81.00	\$70.60	\$67.00	\$65.40	\$62.70	\$60.10
+.127mm HAND TAP	11	PLATING	4	20646	20647	\$59.50	\$57.20	\$54.00	\$50.50	\$47.00	\$45.30	\$42.70	\$40.30
TiN COAT / SP PT TAP	7	6H	3	55005		\$70.20	\$68.80	\$66.70	\$64.20	\$63.50	\$62.20	\$61.30	\$60.10
TiN COAT / HAND TAP	7	6H	4	55006		\$64.70	\$63.40	\$61.30	\$58.80	\$58.00	\$56.80	\$55.90	\$54.70
R.H. ROUND DIE 50.8mm OD				13592		\$100.50	\$88.90	\$83.90	\$80.80	\$80.80	\$80.80	\$73.60	\$73.20
L.H. ROUND DIE 50.8mm OD				13593		\$100.50	\$88.90	\$83.90	\$80.80	\$80.80	\$80.80	\$73.60	\$73.20
GAGE - Taperlock Style		6H		25123		\$162.90							
GAGE - Ring-Go		6g		25320		\$247.70							
GAGE - Ring-NoGo		6g		25321		\$247.70							
<b>M20 X 1.5</b>						<i>Recommended Hole Size Based on 75% Thread = 18.5mm</i>							
HAND TAP	6	6H	4	20656	20657	\$51.40	\$49.50	\$47.20	\$46.70	\$46.70	\$46.70	\$45.80	\$42.70
HAND TAP	3	4H	4	20651	20652	\$84.80	\$83.00	\$76.20	\$63.60	\$50.10	\$48.40	\$45.80	\$43.40
L.H. HAND TAP	6	6H	4	20661	20662	\$62.60	\$60.30	\$57.10	\$53.70	\$50.10	\$48.40	\$45.80	\$43.40
+.127mm HAND TAP	11	PLATING	4	20666	20667	\$59.50	\$57.20	\$54.00	\$50.50	\$47.00	\$45.30	\$42.70	\$40.30
R.H. ROUND DIE 50.8mm OD				13594		\$100.50	\$88.90	\$83.90	\$80.80	\$80.80	\$80.80	\$73.60	\$73.20
L.H. ROUND DIE 50.8mm OD				13595		\$100.50	\$88.90	\$83.90	\$80.80	\$80.80	\$80.80	\$73.60	\$73.20
GAGE - Taperlock Style		6H		25128		\$162.90							
GAGE - Ring-Go		6g		25325		\$247.70							
GAGE - Ring-NoGo		6g		25326		\$247.70							
<b>M20 X 1.0</b>						<i>Recommended Hole Size Based on 75% Thread = 19mm</i>							
HAND TAP	6	6H	4	21048	21049	\$84.80	\$83.00	\$76.20	\$63.60	\$50.10	\$48.40	\$45.80	\$43.40
GAGE - Taperlock Style		6H		21512		\$162.90							
GAGE - Ring-Go		6g		21513		\$261.80							
GAGE - Ring-NoGo		6g		21514		\$261.80							



Click on Item Number for Catalog Listing

SIZE/ DESCRIPTION	GH #	CLASS OF FIT	# FLUTES	ITEM #		1 PC	2 PC	3 PC	6 PC	9 PC	12 PC	24 PC	48 PC
				PLUG	BOTTOM								
<b>M22 X 2.5</b>						<i>Recommended Hole Size Based on 75% Thread = 19.5mm</i>							
HAND TAP	7	6H	4	20676	20677	\$65.90	\$63.50	\$54.80	\$53.00	\$49.50	\$47.80	\$45.20	\$42.60
HAND TAP	4	4H	4	20671	20672	\$88.70	\$73.90	\$63.50	\$53.00	\$49.50	\$47.80	\$45.20	\$42.60
L.H. HAND TAP	7	6H	4	20681	20682	\$68.00	\$65.60	\$56.90	\$55.10	\$51.60	\$49.90	\$47.30	\$44.70
R.H. ROUND DIE 50.8mm OD				13598		\$100.50	\$88.90	\$83.90	\$80.80	\$80.80	\$80.80	\$73.60	\$73.20
GAGE - Taperlock Style		6H		25133		\$162.90							
GAGE - Ring-Go		6g		25330		\$254.90							
GAGE - Ring-NoGo		6g		25331		\$254.90							
<b>M22 X 1.5</b>						<i>Recommended Hole Size Based on 75% Thread = 20.5mm</i>							
HAND TAP	6	6H	4	20691	20692	\$65.90	\$63.50	\$54.80	\$53.00	\$49.50	\$47.80	\$45.20	\$42.60
HAND TAP	3	4H	4	20686	20687	\$88.70	\$73.90	\$63.50	\$53.00	\$49.50	\$47.80	\$45.20	\$42.60
L.H. HAND TAP	6	6H	4	20696	20697	\$68.00	\$65.60	\$56.90	\$55.10	\$51.60	\$49.90	\$47.30	\$44.70
+ .127mm HAND TAP	11	PLATING	4	20701	20702	\$65.90	\$63.50	\$54.80	\$53.00	\$49.50	\$47.80	\$45.20	\$42.60
R.H. ROUND DIE 50.8mm OD				13600		\$100.50	\$88.90	\$83.90	\$80.80	\$80.80	\$80.80	\$73.60	\$73.20
GAGE - Taperlock Style		6H		25138		\$162.90							
GAGE - Ring-Go		6g		25335		\$254.90							
GAGE - Ring-NoGo		6g		25336		\$254.90							
<b>M24 X 3.0</b>						<i>Recommended Hole Size Based on 75% Thread = 21mm</i>							
HAND TAP	8	6H	4	20711	20712	\$73.50	\$72.10	\$66.80	\$65.60	\$63.20	\$55.60	\$49.40	\$45.60
SPIRAL POINT TAP	8	6H	3	21029		\$79.80	\$78.30	\$73.10	\$69.40	\$67.10	\$58.80	\$52.50	\$48.70
HAND TAP	4	4H	4	20706	20707	\$100.60	\$75.00	\$57.80	\$56.10	\$52.50	\$50.80	\$48.20	\$45.60
L.H. HAND TAP	8	6H	4	20716	20717	\$73.50	\$72.10	\$66.80	\$65.60	\$63.20	\$55.60	\$49.40	\$45.60
+ .127mm HAND TAP	11	PLATING	4	20721	20722	\$66.40	\$63.90	\$60.80	\$58.50	\$54.90	\$53.20	\$50.60	\$48.00
TiN COAT / HAND TAP	8	6H	4	55007		\$89.10	\$87.60	\$82.40	\$81.10	\$78.70	\$71.20	\$64.90	\$61.20
R.H. ROUND DIE 50.8mm OD				13604		\$100.50	\$88.90	\$83.90	\$80.80	\$80.80	\$80.80	\$73.60	\$73.20
L.H. ROUND DIE 50.8mm OD				13605		\$100.50	\$88.90	\$83.90	\$80.80	\$80.80	\$80.80	\$73.60	\$73.20
GAGE - Taperlock Style		6H		25143		\$184.60							
GAGE - Ring-Go		6g		25340		\$309.10							
GAGE - Ring-NoGo		6g		25341		\$309.10							
<b>M24 X 2.0</b>						<i>Recommended Hole Size Based on 75% Thread = 22mm</i>							
HAND TAP	7	6H	4	20731	20732	\$73.50	\$72.10	\$66.80	\$65.60	\$63.20	\$55.60	\$49.40	\$45.60
HAND TAP	4	4H	4	20726	20727	\$100.60	\$75.00	\$57.80	\$56.10	\$52.50	\$50.80	\$48.20	\$45.60
L.H. HAND TAP	7	6H	4	20736	20737	\$73.50	\$72.10	\$66.80	\$65.60	\$63.20	\$55.60	\$49.40	\$45.60
R.H. ROUND DIE 50.8mm OD				13606		\$100.50	\$88.90	\$83.90	\$80.80	\$80.80	\$80.80	\$73.60	\$73.20
L.H. ROUND DIE 50.8mm OD				13607		\$100.50	\$88.90	\$83.90	\$80.80	\$80.80	\$80.80	\$73.60	\$73.20
GAGE - Taperlock Style		6H		25148		\$184.60							
GAGE - Ring-Go		6g		25345		\$309.10							
GAGE - Ring-NoGo		6g		25346		\$309.10							
<b>M24 X 1.5</b>						<i>Recommended Hole Size Based on 75% Thread = 22.5mm</i>							
HAND TAP	6	6H	4	20917	20918	\$73.50	\$72.10	\$66.80	\$65.60	\$63.20	\$55.60	\$49.40	\$45.60
GAGE - Taperlock Style		6H		21545		\$223.90							
GAGE - Ring-Go		6g		21546		\$286.30							
GAGE - Ring-NoGo		6g		21547		\$286.30							
<b>M25 X 1.5</b>						<i>Recommended Hole Size Based on 75% Thread = 23.5mm</i>							
HAND TAP	6	6H	4	21031	21032	\$117.30	\$93.80	\$67.80	\$57.30	\$53.80	\$52.10	\$49.50	\$46.90
GAGE - Taperlock Style		6H		21548		\$194.10							

TAPS, DIES & GAGES

Click on Item Number for Catalog Listing

SIZE/ DESCRIPTION	GH #	CLASS OF FIT	# FLUTES	ITEM #		1 PC	2 PC	3 PC	6 PC	9 PC	12 PC	24 PC	48 PC
				PLUG	BOTTOM								
<b>M25 X 1.5</b>						<i>See Previous Page for Recommended Hole Size</i>							
GAGE - Ring-Go		6g		21549		\$313.40							
GAGE - Ring-NoGo		6g		21550		\$313.40							
<b>M26 X 1.5</b>						<i>Recommended Hole Size Based on 75% Thread = 24.5mm</i>							
<b>HAND TAP</b>	<b>6</b>	<b>6H</b>	<b>6</b>	<b>20981</b>	<b>20982</b>	\$117.30	\$93.80	\$88.10	\$77.70	\$75.40	\$72.50	\$69.90	\$64.60
GAGE - Taperlock Style		6H		21557		\$238.80							
GAGE - Ring-Go		6g		21558		\$321.60							
GAGE - Ring-NoGo		6g		21559		\$321.60							
<b>M27 X 3.0</b>						<i>Recommended Hole Size Based on 75% Thread = 24mm</i>							
<b>HAND TAP</b>	<b>8</b>	<b>6H</b>	<b>4</b>	<b>20746</b>	<b>20747</b>	\$108.60	\$93.30	\$82.80	\$72.40	\$68.80	\$67.10	\$64.50	\$61.90
<b>HAND TAP</b>	<b>5</b>	<b>4H</b>	<b>4</b>	<b>20741</b>	<b>20742</b>	\$108.60	\$93.30	\$82.80	\$72.40	\$68.80	\$67.10	\$64.50	\$61.90
<b>L.H. HAND TAP</b>	<b>8</b>	<b>6H</b>	<b>4</b>	<b>20751</b>	<b>20752</b>	\$108.60	\$93.30	\$82.80	\$72.40	\$68.80	\$67.10	\$64.50	\$61.90
R.H. ROUND DIE 63.5mm OD				13614		\$143.50	\$122.10	\$119.30	\$116.80	\$116.80	\$116.80	\$106.80	\$106.10
GAGE - Taperlock Style		6H		25158		\$228.00							
GAGE - Ring-Go		6g		25350		\$323.80							
GAGE - Ring-NoGo		6g		25351		\$323.80							
<b>M27 X 2.0</b>						<i>Recommended Hole Size Based on 75% Thread = 25mm</i>							
<b>HAND TAP</b>	<b>7</b>	<b>6H</b>	<b>4</b>	<b>20761</b>	<b>20762</b>	\$108.60	\$93.30	\$82.80	\$72.40	\$68.80	\$67.10	\$64.50	\$61.90
<b>HAND TAP</b>	<b>5</b>	<b>4H</b>	<b>4</b>	<b>20756</b>	<b>20757</b>	\$108.60	\$93.30	\$82.80	\$72.40	\$68.80	\$67.10	\$64.50	\$61.90
R.H. ROUND DIE 63.5mm OD				13616		\$143.50	\$122.10	\$119.30	\$116.80	\$116.80	\$116.80	\$106.80	\$106.10
GAGE - Taperlock Style		6H		25163		\$228.00							
GAGE - Ring-Go		6g		25355		\$323.80							
GAGE - Ring-NoGo		6g		25356		\$323.80							
<b>M27 X 1.5</b>						<i>Recommended Hole Size Based on 75% Thread = 25.5mm</i>							
<b>HAND TAP</b>	<b>6</b>	<b>6H</b>	<b>6</b>	<b>21057</b>	<b>21058</b>	\$117.30	\$93.80	\$85.50	\$75.10	\$71.50	\$69.90	\$67.20	\$64.60
GAGE - Taperlock Style		6H		21578		\$238.80							
GAGE - Ring-Go		6g		21579		\$283.60							
GAGE - Ring-NoGo		6g		21580		\$283.60							
<b>M30 X 3.5</b>						<i>Recommended Hole Size Based on 75% Thread = 26.5mm</i>							
<b>HAND TAP</b>	<b>9</b>	<b>6H</b>	<b>4</b>	<b>20776</b>	<b>20777</b>	\$166.30	\$131.10	\$110.20	\$104.30	\$91.10	\$82.20	\$78.80	\$73.60
<b>HAND TAP</b>	<b>5</b>	<b>4H</b>	<b>4</b>	<b>20771</b>	<b>20772</b>	\$166.30	\$131.10	\$110.20	\$104.30	\$91.10	\$82.20	\$78.80	\$73.60
<b>L.H. HAND TAP</b>	<b>9</b>	<b>6H</b>	<b>4</b>	<b>20781</b>	<b>20782</b>	\$166.30	\$131.10	\$110.20	\$104.30	\$91.10	\$82.20	\$78.80	\$73.60
R.H. ROUND DIE 63.5mm OD				13624		\$143.50	\$122.10	\$119.30	\$116.80	\$116.80	\$116.80	\$106.80	\$106.10
L.H. ROUND DIE 63.5mm OD				13625		\$143.50	\$122.10	\$119.30	\$116.80	\$116.80	\$116.80	\$106.80	\$106.10
GAGE - Taperlock Style		6H		25168		\$254.90							
GAGE - Ring-Go		6g		25360		\$350.90							
GAGE - Ring-NoGo		6g		25361		\$350.90							
<b>M30 X 2.0</b>						<i>Recommended Hole Size Based on 75% Thread = 26mm</i>							
<b>HAND TAP</b>	<b>7</b>	<b>6H</b>	<b>4</b>	<b>20791</b>	<b>20792</b>	\$166.30	\$131.10	\$110.20	\$104.30	\$91.10	\$82.20	\$78.80	\$73.60
<b>HAND TAP</b>	<b>5</b>	<b>4H</b>	<b>4</b>	<b>20786</b>	<b>20787</b>	\$166.30	\$131.10	\$110.20	\$104.30	\$91.10	\$82.20	\$78.80	\$73.60
R.H. ROUND DIE 63.5mm OD				13626		\$143.50	\$122.10	\$119.30	\$116.80	\$116.80	\$116.80	\$106.80	\$106.10
GAGE - Taperlock Style		6H		25173		\$254.90							
GAGE - Ring-Go		6g		25365		\$350.90							
GAGE - Ring-NoGo		6g		25366		\$350.90							
<b>M30 X 1.5</b>						<i>Recommended Hole Size Based on 75% Thread = 28.5mm</i>							
<b>HAND TAP</b>	<b>6</b>	<b>6H</b>	<b>6</b>	<b>20898</b>	<b>20899</b>	\$175.30	\$160.20	\$145.00	\$131.50	\$91.10	\$60.10	\$59.00	\$58.40



Click on Item Number for Catalog Listing

SIZE/ DESCRIPTION	GH #	CLASS OF FIT	# FLUTES	ITEM #		1 PC	2 PC	3 PC	6 PC	9 PC	12 PC	24 PC	48 PC
				PLUG	BOTTOM								
<b>M30 X 1.5</b>						<i>See Previous Page for Recommended Hole Size</i>							
GAGE - Taperlock Style		6H		21593		\$241.50							
GAGE - Ring-Go		6g		21594		\$313.40							
GAGE - Ring-NoGo		6g		21595		\$313.40							
<b>M32 X 2.0</b>						<i>Recommended Hole Size Based on 75% Thread = 30mm</i>							
<b>HAND TAP</b>	<b>7</b>	<b>6H</b>	<b>6</b>	<b>21199</b>	<b>21200</b>	\$182.10	\$150.70	\$119.50	\$108.90	\$101.80	\$98.50	\$93.30	\$88.00
GAGE - Taperlock Style		6H		21602		\$286.30							
GAGE - Ring-Go		6g		21603		\$343.20							
GAGE - Ring-NoGo		6g		21604		\$343.20							
<b>M32 X 1.5</b>						<i>Recommended Hole Size Based on 75% Thread = 30.5mm</i>							
<b>HAND TAP</b>	<b>6</b>	<b>6H</b>	<b>6</b>	<b>21060</b>	<b>21061</b>	\$182.00	\$145.70	\$101.90	\$83.60	\$75.60	\$70.70	\$68.10	\$65.50
GAGE - Taperlock Style		6H		21611		\$286.30							
GAGE - Ring-Go		6g		21612		\$343.20							
GAGE - Ring-NoGo		6g		21613		\$343.20							
<b>M33 X 3.5</b>						<i>Recommended Hole Size Based on 75% Thread = 29.5mm</i>							
<b>HAND TAP</b>	<b>9</b>	<b>6H</b>	<b>4</b>	<b>20806</b>	<b>20807</b>	\$182.10	\$150.70	\$119.50	\$108.90	\$101.80	\$98.50	\$93.30	\$88.00
<b>HAND TAP</b>	<b>5</b>	<b>4H</b>	<b>4</b>	<b>20801</b>	<b>20802</b>	\$182.10	\$150.70	\$119.50	\$108.90	\$101.80	\$98.50	\$93.30	\$88.00
GAGE - Taperlock Style		6H		25178		\$273.10							
GAGE - Ring-Go		6g		25370		\$363.50							
GAGE - Ring-NoGo		6g		25371		\$363.50							
<b>M33 X 2.0</b>						<i>Recommended Hole Size Based on 75% Thread = 31mm</i>							
<b>HAND TAP</b>	<b>7</b>	<b>6H</b>	<b>4</b>	<b>20821</b>	<b>20822</b>	\$182.10	\$150.70	\$119.50	\$108.90	\$101.80	\$98.50	\$93.30	\$88.00
<b>HAND TAP</b>	<b>5</b>	<b>4H</b>	<b>4</b>	<b>20816</b>	<b>20817</b>	\$182.10	\$150.70	\$119.50	\$108.90	\$101.80	\$98.50	\$93.30	\$88.00
R.H. ROUND DIE 63.5mm OD				13634		\$143.50	\$122.10	\$119.30	\$116.80	\$116.80	\$116.80	\$106.80	\$106.10
GAGE - Taperlock Style		6H		25183		\$273.10							
GAGE - Ring-Go		6g		25375		\$363.50							
GAGE - Ring-NoGo		6g		25376		\$363.50							
<b>M35 X 1.5</b>						<i>Recommended Hole Size Based on 75% Thread = 33.5mm</i>							
<b>HAND TAP</b>	<b>6</b>	<b>6H</b>	<b>6</b>	<b>20957</b>	<b>20958</b>	\$175.30	\$154.30	\$105.20	\$91.20	\$83.60	\$76.30	\$75.00	\$72.40
GAGE - Taperlock Style		6H		21632		\$256.50							
GAGE - Ring-Go		6g		21633		\$366.30							
GAGE - Ring-NoGo		6g		21634		\$366.30							
<b>M36 X 4.0</b>						<i>Recommended Hole Size Based on 75% Thread = 32mm</i>							
<b>HAND TAP</b>	<b>9</b>	<b>6H</b>	<b>4</b>	<b>20836</b>	<b>20837</b>	\$235.60	\$190.40	\$141.30	\$120.40	\$113.30	\$110.00	\$104.80	\$99.50
<b>HAND TAP</b>	<b>5</b>	<b>4H</b>	<b>4</b>	<b>20831</b>	<b>20832</b>	\$235.60	\$190.40	\$141.30	\$120.40	\$113.30	\$110.00	\$104.80	\$99.50
R.H. ROUND DIE 63.5mm OD				13638		\$143.50	\$122.10	\$119.30	\$116.80	\$116.80	\$116.80	\$106.80	\$106.10
GAGE - Taperlock Style		6H		25188		\$302.10							
GAGE - Ring-Go		6g		25380		\$405.10							
GAGE - Ring-NoGo		6g		25381		\$405.10							
<b>M36 X 3.0</b>						<i>Recommended Hole Size Based on 75% Thread = 33mm</i>							
<b>HAND TAP</b>	<b>8</b>	<b>6H</b>	<b>4</b>	<b>20851</b>	<b>20852</b>	\$235.60	\$190.40	\$141.30	\$120.40	\$113.30	\$110.00	\$104.80	\$99.50
<b>HAND TAP</b>	<b>5</b>	<b>4H</b>	<b>4</b>	<b>20846</b>	<b>20847</b>	\$235.60	\$190.40	\$141.30	\$120.40	\$113.30	\$110.00	\$104.80	\$99.50
R.H. ROUND DIE 63.5mm OD				13640		\$143.50	\$122.10	\$119.30	\$116.80	\$116.80	\$116.80	\$106.80	\$106.10
GAGE - Taperlock Style		6H		25193		\$302.10							
GAGE - Ring-Go		6g		25385		\$405.10							
GAGE - Ring-NoGo		6g		25386		\$405.10							



TAPS, DIES & GAGES

Click on Item Number for Catalog Listing

SIZE/ DESCRIPTION	GH #	CLASS OF FIT	# FLUTES	ITEM #		1 PC	2 PC	3 PC	6 PC	9 PC	12 PC	24 PC	48 PC
				PLUG	BOTTOM								
<b>M36 X 2.0</b>						<i>Recommended Hole Size Based on 75% Thread = 34mm</i>							
HAND TAP	7	6H	6	20921	20922	\$235.60	\$190.40	\$141.30	\$120.40	\$113.30	\$110.00	\$107.60	\$104.70
GAGE - Taperlock Style		6H		21653		\$271.30							
GAGE - Ring-Go		6g		21654		\$373.10							
GAGE - Ring-NoGo		6g		21655		\$373.10							
<b>M36 X 1.5</b>						<i>Recommended Hole Size Based on 75% Thread = 34.5 mm</i>							
HAND TAP	6	6H	6	20961	20962	\$177.10	\$156.10	\$128.50	\$103.70	\$91.50	\$82.10	\$76.80	\$74.10
GAGE - Taperlock Style		6H		21662		\$271.30							
GAGE - Ring-Go		6g		21663		\$373.10							
GAGE - Ring-NoGo		6g		21664		\$373.10							
<b>M39 X 4.0</b>						<i>Recommended Hole Size Based on 75% Thread = 35mm</i>							
HAND TAP	9	6H	6	20866	20867	\$241.30	\$213.80	\$180.60	\$148.40	\$129.10	\$127.30	\$120.50	\$115.30
HAND TAP	6	4H	6	20861	20862	\$241.30	\$213.80	\$180.60	\$148.40	\$129.10	\$127.30	\$120.50	\$115.30
GAGE - Tri-Lock Style		6H		25198		\$320.20							
GAGE - Ring-Go		6g		25390		\$444.70							
GAGE - Ring-NoGo		6g		25391		\$444.70							
<b>M39 X 3.0</b>						<i>Recommended Hole Size Based on 75% Thread = 36mm</i>							
HAND TAP	8	6H	6	20881	20882	\$241.30	\$213.80	\$180.60	\$148.40	\$129.10	\$127.30	\$120.50	\$115.30
HAND TAP	6	4H	6	20876	20877	\$241.30	\$213.80	\$180.60	\$148.40	\$129.10	\$127.30	\$120.50	\$115.30
R.H. ROUND DIE 76.2mm OD				13648		\$196.50	\$188.80	\$183.80	\$116.80	\$116.80	\$116.80	\$106.80	\$106.10
GAGE - Tri-Lock Style		6H		25203		\$320.20							
GAGE - Ring-Go		6g		25395		\$444.70							
GAGE - Ring-NoGo		6g		25396		\$444.70							
<b>M40 X 1.5</b>						<i>Recommended Hole Size Based on 75% Thread = 38.5mm</i>							
HAND TAP	6	6H	6	20972	20973	\$234.20	\$197.10	\$159.60	\$136.10	\$130.50	\$117.20	\$107.10	\$93.70
<b>M42 X 4.5</b>						<i>Recommended Hole Size Based on 75% Thread = 37.5mm</i>							
HAND TAP	10	6H	6	20965	20966	\$334.70	\$267.60	\$187.30	\$153.90	\$149.90	\$144.70	\$133.60	\$131.00
<b>M42 X 1.5</b>						<i>Recommended Hole Size Based on 75% Thread = 40.5mm</i>							
HAND TAP	6	6H	6	21063	21064	\$222.40	\$177.90	\$124.50	\$115.10	\$109.70	\$107.30	\$105.10	\$101.20

- The recommended hole sizes shown are reference values, and depending on specific tapping requirements and conditions, may have to be altered. North American Tool Corporation assumes no responsibility or liability of any kind as a result of the selection of tap hole sizes from this catalog.
- Dimensions shown for metric taps are decimal inch values, and are not metric (mm) values.
- Note: For Unified, Metric and Pipe EXTENSION taps, S.T.I. tap and gage sizes, or SPECIAL taps NOT LISTED, please contact our Customer Service Dept.
- FOR QUESTIONS, PLEASE CONTACT OUR CUSTOMER SERVICE DEPT.
- Prices and conditions are subject to change without notice.





SMART CUT TAPPING & DRILLING FLUID



- Maximum accuracy in machined parts.
- Increases productivity.
- Extends life of the tap.
- Excellent friction-reducing properties.
- Can be used for many machining applications including drilling and sawing.

Why 'Smart Cut™' Tapping And Cutting Fluid From North American Tool?

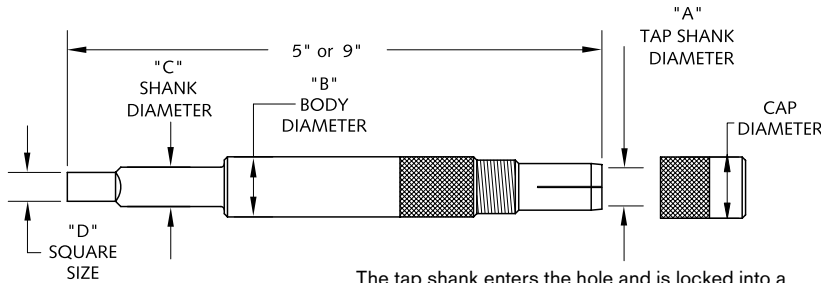
- Environmentally SMART...ozone friendly.
- Contains no carbon tetrachloride or 1,1,1-Trichloroethane.
- Designed to extend tool life.
- Penetrates to the tool's cutting edge and stays on the tool.
- Eliminates the hassles of costly hazardous waste disposal.
- Smart Cut is thick, won't evaporate and stays on the tool throughout the cutting operation.
- Does not contain any animal-derived components or components synthesized from animal-derived materials.



SMART CUT TAPPING FLUID

PART NUMBER	DESCRIPTION	SIZE	LIST PRICE
FL110	Smart Cut	16 oz.	\$11.20
FL115	Smart Cut	16 oz. (12/case)	\$125.90
FL120	Smart Cut	1 gallon	\$69.00
FL125	Smart Cut	1 gallon (4/case)	\$266.60
FL130	Smart Cut	5 gallon	\$270.20
FL135	Smart Cut	55 gallon drum	\$2,783.10

Click on Part Number above for Catalog Listing



The tap shank enters the hole and is locked into a square in the bottom of the hole. The tap is then secured by hand tightening the compression cap.



5" Tap Extension Set w/Case (9-piece) shown. Also available in 9" Sets.

- Hand Tap Extensions 5" & 9" Length
- Made from tool steel.
- Internal square drive for positive tap drive.
- Compression cap for easy tightening. No wrench required.
- A very effective tool at low cost.
- The slim profile lets you fit into places not accessible to conventional tap extensions.
- Eliminates the need for purchasing expensive extended length taps.
- Integral compression collet eliminates the need for bulky collet nuts.

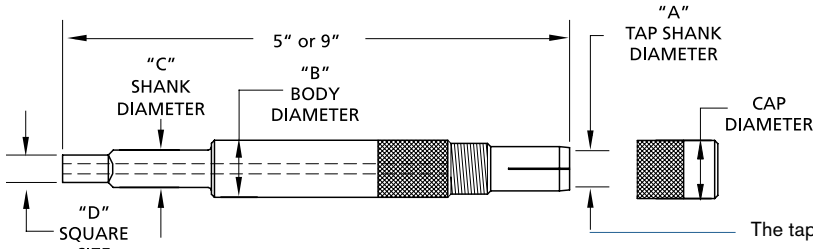
Click on EDP Number for Catalog Listing

EDP NUMBER	LIST PRICE	NOMINAL TAP SIZE	METRIC TAP SIZE ASME/ANSI B94.9 - 1987	DIA OF TAP SHANK (INCH)	EXT DIA (INCH)	SHANK DIA (INCH)	SQUARE SIZE (INCH)	DEPTH TAP ENTERS
<b>5" TAP EXTENSIONS (CAP Diameter = "B" Body Diameter)</b>								
21700	\$51.50	#0-#6	M1.6-M3.5	0.141	1/4"	0.194	0.152	7/8"
21701	\$51.50	#8	M4	0.168	5/16"	0.194	0.152	7/8"
21702	\$51.50	#10	M4.5-M5	0.194	3/8"	0.194	0.152	1"
21703	\$51.50	#12		0.22	3/8"	0.194	0.152	1"
21704	\$51.50	1/4"	M6-M6.3	0.255	7/16"	0.255	0.191	1"
21705	\$63.10	5/16"	M7 & M8	0.318	1/2"	0.318	0.238	1 1/16"
21706	\$63.10	3/8"	M10	0.381	9/16"	0.381	0.286	1 1/8"
21707	\$63.10	7/16"		0.323	1/2"	0.323	0.242	1 1/16"
21708	\$63.10	1/2"	M12	0.367	9/16"	0.367	0.275	1 1/8"
21709	\$63.10	1/16 & 1/8 RS NPT		0.312	1/2"	0.312	0.234	1"
21796	\$478.90	5" Tap Extension Set w/Case (9-piece set includes EDP No. 21700 thru 21708)						
<b>9" TAP EXTENSIONS (CAP Diameter = "B" Body Diameter)</b>								
21805	\$54.10	#0-#6	M1.6-M3.5	0.141	1/4"	0.194	0.152	7/8"
21710	\$54.10	#8	M4	0.168	5/16"	0.194	0.152	7/8"
21711	\$54.10	#10	M4.5-M5	0.194	3/8"	0.194	0.152	1"
21712	\$54.10	#12		0.22	3/8"	0.194	0.152	1"
21713	\$54.10	1/4"	M6	0.255	7/16"	0.255	0.191	1"
21714	\$66.50	5/16"	M7 & M8	0.318	1/2"	0.318	0.238	1 1/16"
21715	\$66.50	3/8"	M10	0.381	9/16"	0.381	0.286	1 1/8"
21716	\$66.50	7/16"		0.323	1/2"	0.323	0.242	1 1/16"
21717	\$66.50	1/2"	M12	0.367	9/16"	0.367	0.275	1 1/8"
21718	\$66.50	1/16 & 1/8 RS NPT		0.312	1/2"	0.312	0.234	1"
21797	\$499.40	9" Tap Extension Set w/Case (9-piece set includes EDP No. 21805 thru 21717)						
<b>6" TAP EXTENSIONS (For Taps Larger Than 1/2") (CAP Diameter = 1/8" Greater than "B" Body Diameter)</b>								
21719	\$94.20	9/16"		0.429	3/4"	0.429	0.320	1 1/4"
21720	\$94.20	1/8 NPT		0.437	3/4"	0.437	0.328	1"
21721	\$94.20	5/8"	M16	0.480	3/4"	0.480	0.360	1 1/4"
21722	\$107.70	11/16"		0.542	7/8"	0.542	0.406	1 1/4"
21723	\$117.70	1/4 NPT		0.562	7/8"	0.562	0.420	1"
21724	\$107.70	3/4"		0.590	7/8"	0.590	0.440	1 3/8"
21725	\$107.70	7/8"		0.697	1"	0.697	0.520	1 3/8"
21726	\$107.70	3/8 NPT		0.700	1"	0.700	0.530	1 3/16"
21727	\$107.70	1/2 NPT		0.687	1"	0.687	0.515	1 1/4"
21798	\$107.70	1"		0.800	1"	0.800	0.600	1 1/2"



Specify quantity, EDP number, tap size and extension length.

# TAP EXTENSIONS FOR COOLANT-THROUGH ANSI STANDARD TAPS



The tap shank enters the hole and is locked into a square in the bottom of the hole. The tap is then secured by hand tightening the compression cap.

- Coolant-Through Hand Tap Extensions 5" & 9" Length
- Made from tool steel.
- Internal square drive for positive tap drive.
- Compression cap for easy tightening. No wrench required.
- A very effective tool at low cost.
- The slim profile lets you fit into places not accessible to conventional tap extensions.
- Eliminates the need for purchasing expensive extended length taps.
- Integral compression collet eliminates the need for bulky collet nuts.

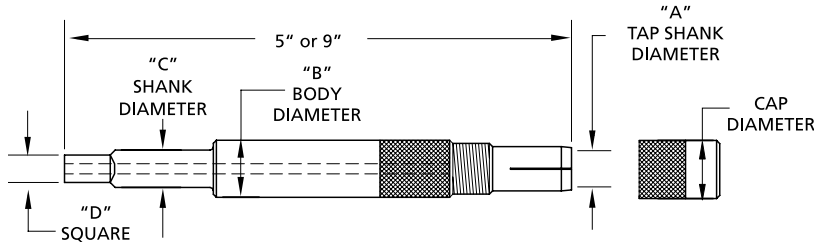


Click on EDP Number for Catalog Listing

EDP NUMBER	LIST PRICE	NOMINAL TAP SIZE	METRIC TAP SIZE ASME/ANSI B94.9 - 1987	DIA OF TAP SHANK (INCH)	EXT DIA (INCH)	SHANK DIA (INCH)	SQUARE SIZE (INCH)	DEPTH TAP ENTERS	COOLANT HOLE DIA
<b>5" COOLANT THRU TAP EXTENSIONS (CAP Diameter = "B" Body Diameter)</b>									
21728	\$152.30	#0-#6	M1.6-M3.5	0.141	1/4"	0.194	0.152	7/8"	7/64
21729	\$152.30	#8	M4	0.168	5/16"	0.194	0.152	7/8"	7/64
21730	\$152.30	#10	M4.5-M5	0.194	3/8"	0.194	0.152	1"	7/64
21731	\$152.30	#12		0.22	3/8"	0.194	0.152	1"	7/64
21732	\$119.40	1/4"	M6-M6.3	0.255	7/16"	0.255	0.191	1"	3/32
21733	\$119.40	5/16"	M7 & M8	0.318	1/2"	0.318	0.238	1 1/16"	5/32
21734	\$119.40	3/8"	M10	0.381	9/16"	0.381	0.286	1 1/8"	5/32
21735	\$119.40	7/16"		0.323	1/2"	0.323	0.242	1 1/16"	5/32
21736	\$119.40	1/2"	M12	0.367	9/16"	0.367	0.275	1 1/8"	5/32
21799	\$119.40	1/16 & 1/8 RS NPT		0.312	1/2"	0.312	0.234	1"	5/32
<b>9" COOLANT THRU TAP EXTENSIONS (CAP Diameter = "B" Body Diameter)</b>									
21737	\$213.10	#0-#6	M1.6-M3.5	0.141	1/4"	0.194	0.152	7/8"	7/64
21738	\$213.10	#8	M4	0.168	5/16"	0.194	0.152	7/8"	7/64
21739	\$213.10	#10	M4.5-M5	0.194	3/8"	0.194	0.152	1"	7/64
21740	\$213.10	#12		0.22	3/8"	0.194	0.152	1"	7/64
21741	\$213.10	1/4"	M6-M6.3	0.255	7/16"	0.255	0.191	1"	3/32
21742	\$213.10	5/16"	M7 & M8	0.318	1/2"	0.318	0.238	1 1/16"	5/32
21743	\$213.10	3/8"	M10	0.381	9/16"	0.381	0.286	1 1/8"	5/32
21744	\$213.10	7/16"		0.323	1/2"	0.323	0.242	1 1/16"	5/32
21745	\$213.10	1/2"	M12	0.367	9/16"	0.367	0.275	1 1/8"	5/32
21800	\$213.10	1/16 & 1/8 RS NPT		0.312	1/2"	0.312	0.234	1"	5/32
<b>6" COOLANT THRU TAP EXTENSIONS (For Taps Larger Than 1/2") (CAP Diameter = 1/8" Greater than "B" Body Diameter)</b>									
21746	\$243.50	9/16"		0.429	3/4"	0.429	0.320	1 1/4"	3/16
21747	\$243.50	1/8 NPT		0.437	3/4"	0.437	0.328	1"	3/16
21748	\$243.50	5/8"	M16	0.480	3/4"	0.48	0.360	1 1/4"	3/16
21749	\$243.50	11/16"		0.542	7/8"	0.542	0.406	2 1/4"	3/16
21750	\$243.50	1/4 NPT		0.562	7/8"	0.562	0.420	1"	3/16
21751	\$243.50	3/4"		0.590	7/8"	0.59	0.440	1 3/8"	3/16
21752	\$243.50	7/8"		0.697	1"	0.697	0.520	1 3/8"	3/16
21753	\$243.50	3/8 NPT		0.700	1"	0.7	0.530	1 3/16"	3/16
21754	\$243.50	1/2 NPT		0.687	1"	0.687	0.515	1 1/4"	3/16
21755	\$243.50	1"		0.800	1"	0.8	0.600	1 1/2"	3/16

Specify quantity, EDP number, tap size and extension length.





The tap shank enters the hole and is locked into a square in the bottom of the hole. The tap is then secured by hand tightening the compression cap.

- Metric DIN Hand Tap Extensions 5" & 9" Length
- All popular DIN metric sizes.
- All the most popular sizes available for coolant-through taps.
- Made from tool steel.
- Internal square drive for positive tap drive.
- Compression cap for easy tightening. No wrench required.
- A very effective tool at low cost.
- The slim profile lets you fit into places not accessible to conventional tap extensions.
- Eliminates the need for purchasing expensive extended length taps.
- Integral compression collet eliminates the need for bulky collet nuts.

Click on EDP Number for Catalog Listing

Click on EDP Number for Catalog Listing

EDP NUMBER	LIST PRICE	TAPS WITH DIN 371 SHANKS	TAPS WITH DIN 374/376 SHANKS	DIA OF TAP SHANK (MM)	DIA OF SHANK (INCH)	DEPTH TAP ENTERS	EXT DIA	SHANK DIA (MM)	SHANK DIA (INCH)	SQUARE SIZE (MM)	SQUARE SIZE (INCH)	WITH COOLANT HOLE			
												EDP NUMBER	LIST PRICE	COOLANT HOLE SIZE	
<b>5" (127mm) LONG TAP EXTENSIONS (CAP Diameter = "B" Body Diameter)</b>															
21756	\$127.00	M2-M2.6	M4	2.8mm	(0.110)	7/8"	1/4"	6mm	(0.236)	4.9mm	(0.193)	21776	\$197.00	2.36mm	
21757	\$127.00	M3	M4.5-M5	3.5mm	(0.137)	7/8"	5/16"	6mm	(0.236)	4.9mm	(0.193)	21777	\$197.00	2.36mm	
21758	\$127.00	M3.5	M5.5	4.0mm	(0.157)	7/8"	3/8"	6mm	(0.236)	4.9mm	(0.193)	21778	\$197.00	2.36mm	
21759	\$127.00	M4	M6	4.5mm	(0.177)	7/8"	3/8"	6mm	(0.236)	4.9mm	(0.193)	21779	\$197.00	2.36mm	
21760	\$127.00	M4.5-M6	M8	6.0mm	(0.236)	1"	7/16"	7mm	(0.275)	5.5mm	(0.216)	21780	\$197.00	3.96mm	
21761	\$127.00	M7	M9-M10	7.0mm	(0.275)	1"	1/2"	7mm	(0.275)	5.5mm	(0.216)	21781	\$197.00	3.96mm	
21762	\$127.00	M8	M11	8.0mm	(0.315)	1 1/8"	1/2"	8mm	(0.315)	6.2mm	(0.244)	21782	\$197.00	3.96mm	
21763	\$127.00	M9	M12	9.0mm	(0.354)	1 3/16"	5/8"	9mm	(0.354)	7mm	(0.275)	21783	\$197.00	3.96mm	
21764	\$127.00	M10		10.0mm	(0.393)	1 1/4"	5/8"	10mm	(0.393)	8mm	(0.315)	21784	\$197.00	3.96mm	
21765	\$127.00		M14	11.0mm	(0.433)	1 3/8"	3/4"	11mm	(0.433)	9mm	(0.354)	21785	\$197.00	3.96mm	
21801	\$127.00	M12	M16	12.0mm	(0.472)	1 3/8"	3/4"	12mm	(0.472)	9mm	(0.354)	21803	\$197.00	3.96mm	
<b>9" (228.6mm) TAP EXTENSIONS (CAP Diameter = "B" Body Diameter)</b>															
21766	\$169.00	M2-M2.6	M4	2.8mm	(0.110)	7/8"	1/4"	6mm	(0.236)	4.9mm	(0.193)	21786	\$283.70	2.36mm	
21767	\$169.00	M3	M4.5-M5	3.5mm	(0.137)	7/8"	5/16"	6mm	(0.236)	4.9mm	(0.193)	21787	\$283.70	2.36mm	
21768	\$169.00	M3.5	M5.5	4.0mm	(0.157)	7/8"	3/8"	6mm	(0.236)	4.9mm	(0.193)	21788	\$283.70	2.36mm	
21769	\$169.00	M4	M6	4.5mm	(0.177)	7/8"	3/8"	6mm	(0.236)	4.9mm	(0.193)	21789	\$283.70	2.36mm	
21770	\$169.00	M4.5-M6	M8	6.0mm	(0.236)	1"	7/16"	7mm	(0.275)	5.5mm	(0.216)	21790	\$283.70	3.96mm	
21771	\$169.00	M7	M9-M10	7.0mm	(0.275)	1"	1/2"	7mm	(0.275)	5.5mm	(0.216)	21791	\$283.70	3.96mm	
21772	\$169.00	M8	M11	8.0mm	(0.315)	1 1/8"	1/2"	8mm	(0.315)	6.2mm	(0.244)	21792	\$283.70	3.96mm	
21773	\$169.00	M9	M12	9.0mm	(0.354)	1 3/16"	5/8"	9mm	(0.354)	7mm	(0.275)	21793	\$283.70	3.96mm	
21774	\$169.00	M10		10.0mm	(0.393)	1 1/4"	5/8"	10mm	(0.393)	8mm	(0.315)	21794	\$283.70	3.96mm	
21775	\$169.00		M14	11.0mm	(0.433)	1 3/8"	3/4"	11mm	(0.433)	9mm	(0.354)	21795	\$283.70	3.96mm	
21802	\$169.00	M12	M16	12.0mm	(0.472)	1 3/8"	3/4"	12mm	(0.472)	9mm	(0.354)	21804	\$283.70	3.96mm	

Specify quantity, EDP number, tap size and extension length.





**North American Tool**

215 Elmwood Avenue  
PO Box 116  
South Beloit, IL 61080-0116

800-872-8277  
[sales@natool.com](mailto:sales@natool.com)  
[www.natool.com](http://www.natool.com)